

NO. 54

NOVEMBER 1982

MICRO

THE 6502/6809 JOURNAL

for
PET and APPLE
**CASTLE
ADVENTURE**



Games Feature

Atari Character Graphics

Hi-Res Graphics and Memory Use on the APPLE

PET Graphic-80 Conversion



MAGIC WINDOW II

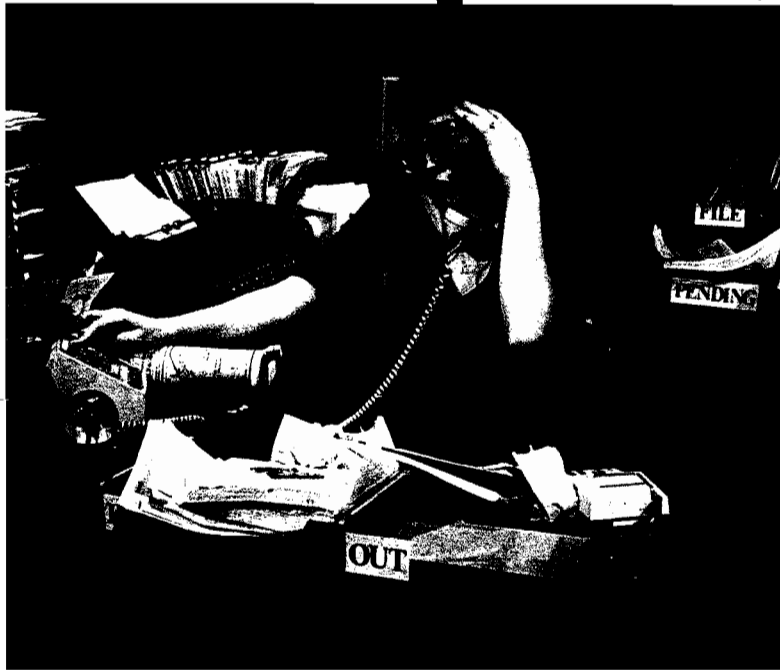

MAKES PAPERWORK PANDEMONIUM VANISH

MAGIC WINDOW II turns your APPLE into a sophisticated word processor. But because MAGIC WINDOW II operates so much like a standard typewriter, it's extremely simple to use. In fact, because of its unique menu structure, it's the easiest to learn, and function selection is virtually error free.

MAGIC WINDOW II's powerful word processing features include automatic formatting, editing, centering, and justification — and these are all done easily "on the video screen" before you ever print. Just type your first draft quickly, then go back and make any needed corrections. You can insert or delete letters or words, even move whole paragraphs with just a few simple keystrokes.

And MAGIC WINDOW II can support 40-, 70-, and 80-column displays, as well as automatically providing 80-column visibility with scrolling. The rule is: What you see on the screen is what you get in print. No word processor on the market has both the features of MAGIC WINDOW II and its simplicity of use.

And as an extra assurance that your document is perfect before printing and mailing, you can use MAGIC WORDS. With incredible speed, MAGIC WORDS proofreads your document for spelling errors and typos, shows you each one in context on the screen, and allows you to correct or ignore each in sequence. Unlike any other spelling checker, it will then automatically create a corrected file as you go so you never need to return to MAGIC WINDOW II to update it yourself manually. Or, if you're busy, MAGIC WORDS will go through your file without waiting for you to act on each error, and provide you with a printout of the errors and their locations so you can correct them at your convenience.

And with a 14,000-word basic dictionary and plenty of memory for you to add technical terms or customer names that you use frequently, MAGIC WORDS becomes a totally personalized program that can catch all your spelling errors and typos.

But now comes the mailing, the really time-consuming part — unless you have MAGIC MAILER. A mailing list merge

system, MAGIC MAILER lets you insert each name and address (or whatever is in your records) into your document quickly and efficiently.

With MAGIC MAILER, you never have to retype a document or an internal address. With just a few keystrokes, each letter becomes an original, and the final phase of the paperwork process is complete — efficiently and to perfection.

Let's face it: The letters, invoices, and other documents you send out represent you to the public. They should be as professional as possible — and they can be. All it takes is a little MAGIC.

Each program is available separately or ask your local software store for Artsci's MAGIC PAK. All three products are included in an attractive library box.

213 / 985-2922





2MHZ 6809 SYSTEMS

GIMIX offers you a variety to choose from!

38 MB WINCHESTER SYSTEM \$17,498.99

HARDWARE FEATURES:

- ★ 2MHz 6809 CPU
- ★ 512KB Static RAM
- ★ 8 RS232C Serial Ports
- ★ 2 Parallel Ports
- ★ DMA Double Density Floppy Disk Controller
- ★ Dual 8" DSDD Floppy Disk System
- ★ Dual Winchester Subsystem with Two 19 MB 5 1/4" Winchester Drives

SOFTWARE FEATURES:

- ★ OS-9 LEVEL TWO Multi-User Operating System
- ★ OS-9 Debugger
- ★ OS-9 Text Editor
- ★ OS-9 Assembler

19 MB WINCHESTER SYSTEM \$8998.09

HARDWARE FEATURES:

- ★ 128K Static Ram
- ★ 2MHz 6809 CPU
- ★ 19 MB 5 1/4" Winchester DMA Subsystem
- ★ 4 RS232C Serial Ports
- ★ 1 MB 5 1/4" Floppy Disk Drive
- ★ DMA Double Density Floppy Disk Controller

SOFTWARE FEATURES:

- ★ OS-9 LEVEL TWO Multi-User Operating System
- ★ OS-9 Text Editor
- ★ OS-9 Debugger
- ★ OS-9 Assembler

128KB MULTI-USER SYSTEM \$6997.39

HARDWARE FEATURES:

- ★ 2MHz 6809 CPU
- ★ DMA Double Density Floppy Disk Controller
- ★ 128KB Static Ram
- ★ 2 RS232C Serial Ports
- ★ Dual 8" DSDD Floppy Disk System

SOFTWARE FEATURES: Your choice of either UniFLEX or OS-9 LEVEL TWO. Both are Unix-like Multi-User/Multi-Tasking Operating Systems.

56KB FLEX / OS-9 'SWITCHING' SYSTEM \$4148.49

HARDWARE FEATURES:

- ★ 2MHz 6809 CPU
- ★ 56K Static Ram
- ★ 2 RS232C Serial Ports
- ★ DMA Double Density Floppy Disk Controller
- ★ 2 Built-in 5 1/4" 40tr DSDD Disk Drives (80 Track DSDD Drive Option . . add \$400.00)

SOFTWARE FEATURES:

- ★ GMXBUG monitor — FLEX Disk Operating System
- ★ OS-9 LEVEL ONE Multi-tasking operating system for up to 56K of memory

WINCHESTER SUBSYSTEMS

Winchester packages are available for upgrading current GIMIX 6809 systems equipped with DMA controllers, at least one floppy disk drive, and running FLEX, OS-9 LEVEL ONE or OS-9 LEVEL TWO. The packages include one or two 19MB (unformatted) Winchester drives, DMA Hard Disk Interface, and the appropriate software drivers. The Interface can handle two 5 1/4" Winchester Drives, providing Automatic Data Error Detection and Correction: up to 22 bit burst error detection and 11 bit burst error correction.

Dual drives can be used together to provide over 30 MBytes of on line storage -- or use one for back-up of the other. (More convenient and reliable than tape backup systems.)

#90 includes one 19MB Drive, Interface, and Software \$4288.90

#91 includes two 19MB Drives, Interface, and Software \$6688.91

Contact GIMIX for systems customized to your needs or for more information.

50 HZ Export Versions Available

GIMIX Inc. reserves the right to change pricing and product specifications at any time without further notice.

GIMIX® and GHOST® are registered trademarks of GIMIX Inc.
FLEX and UniFLEX are trademarks of Technical Systems Consultants Inc.
OS-9 is a trademark of Microware Inc.

1337 WEST 37th PLACE
CHICAGO, ILLINOIS 60609

(312) 927-5510

TWX 910-221-4055

GIMIX Inc.

1982 GIMIX Inc.

THE SKILLS YOU NEED TO MASTER YOUR MICRO IN A FRIENDLY, SELF-PACED FORMAT— FROM WILEY

BASIC FOR THE APPLE II®

Jerald R. Brown, LeRoy Finkel, & Bob Albrecht
A complete, friendly, and virtually guaranteed introduction to BASIC programming on the Apple II®—from fundamental principles, assignment statements, and stored programs to such advanced techniques as string variables and functions, subscripted variables, subroutines, and more.

(1-86596-6) October 1982
416 pp. \$12.95

ATARI® SOUND AND GRAPHICS

Herb Moore, Judy Lower, & Bob Albrecht
Learn how to compose and play melodies, draw cartoons, create games, and combine animation and sound—even if you have no previous computing experience.

(1-09593-1) 1982 234 pp. \$9.95

TRS-80™ COLOR BASIC

Bob Albrecht
Packed with games, experiments, and programming problems and solutions, this manual lets you explore all the applications of the TRS-80™ Color Computer, while it teaches you the fundamentals of BASIC programming.

(1-09644-X) 1982 374 pp. \$9.95

6502 ASSEMBLY LANGUAGE PROGRAMMING

Judi N. Fernandez, Donna N. Tabler, & Ruth Ashley
Puts the speed and efficiency of assembly language programming within reach of owners of APPLES®, ATARIs®, Commodores, or any of the popular microcomputers based on the 6502 microprocessor chip.

(1-86120-0) October 1982
approx. 256 pp. \$12.95

GOLDEN DELICIOUS GAMES FOR THE APPLE® COMPUTER

Howard M. Franklin, JoAnne Koltnow,
& LeRoy Finkel

This delightful guide shows novice and experienced programmers how to use the color, sound, and graphic capabilities of the Apple II® to create their own computer games.

(1-09083-2) 1982 150 pp. \$12.95

More than a million people have learned to program, use, and enjoy microcomputers with Wiley Self-Teaching Guides. Look for them all at your favorite bookshop or computer store.

1807  1982 JOHN WILEY & SONS, Inc.
605 Third Avenue
New York, N.Y. 10158

In Canada: 22 Worcester Road, Rexdale, Ontario M9W 1L1

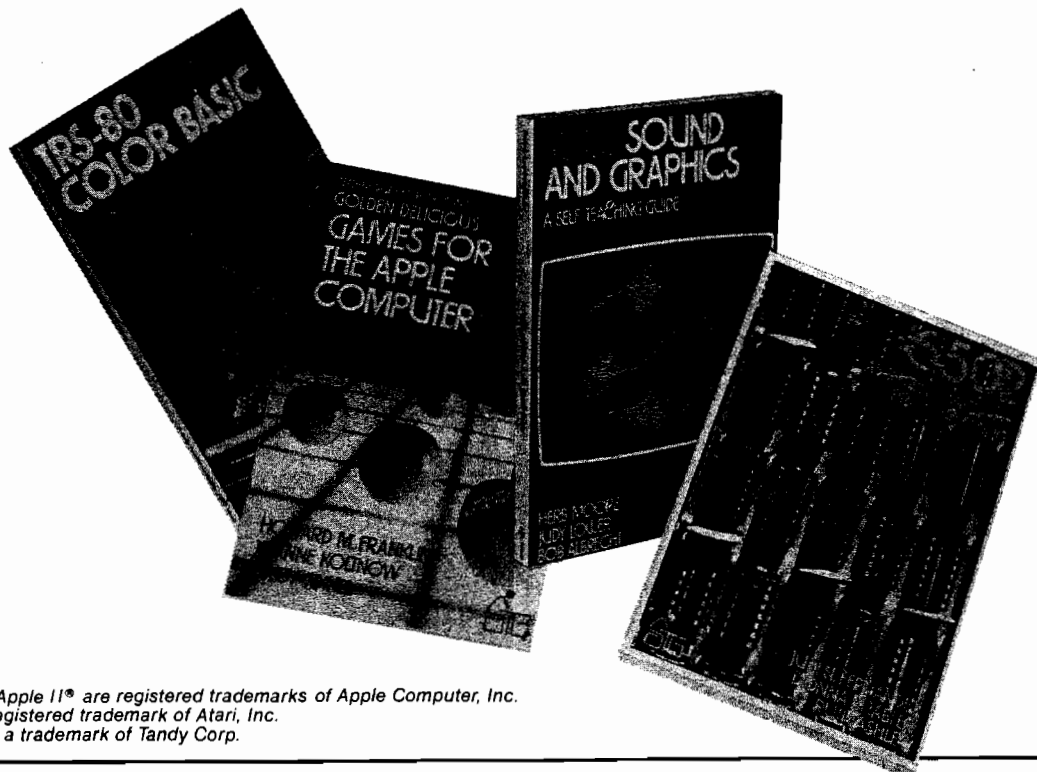

Apple® and Apple II® are registered trademarks of Apple Computer, Inc.
Atari® is a registered trademark of Atari, Inc.
TRS-80™ is a trademark of Tandy Corp.

3-8715

MICRO™

November Highlights

Games Feature

This month we expand a bit from our usual content and offer an array of games for a wide variety of computers. Although we don't usually publish games, we feel that they may be valuable, particularly where they demonstrate techniques or cultivate a skill in the user. Instead of making games a regular part of MICRO, we prefer to do it all at once!

There are specific games for nearly every computer, including the PET, VIC, Apple, C1P/Superboard, Atari 400/800, and the SYM. In addition, you will find that most can be converted easily to run on even more machines. These represent a variety of types of games too — from action games like "Space Invasion" and "Shootdown," to strategy games like "Number Shuffle," "GOMOKU," and "23 Matches," to "Castle Adventure."

Written in the style of Scott Adams' famous games, "Castle Adventure" (p. 41) tests your memory and analytical skills. You will find yourself in the evil baron's castle in a quest for treasure and the kidnapped princess. "Castle Adventure" was originally written for the PET. We have provided specific line changes to make it run on the Apple. However, except for disk commands, it is written in straight Microsoft BASIC, so owners of OSI, Atari [with Microsoft BASIC], and Color Computer [with extended BASIC] machines should be able to easily adapt "Castle Adventure."

"Solve the Pagoda Puzzle Using Recursive Assembly" (p. 53) is particularly interesting because it demonstrates a technique — having a subroutine call itself — that you may want to apply to your own programs. The author's application is in solving the "Pagoda" or "Tower of Hanoi" puzzle. The program solves the puzzle for a stack of disks of any practical height and outputs a list of specific moves. With a minimum of changes, it will run on any 6502 computer. You may want to try incorporating this routine into a BASIC program that actually shows the disks being moved from peg to peg.

"GOMOKU" (p. 59) is a fast, machine-language version of the oriental game of strategy. It is presented here for VIC, with modifications for PET. "Number Shuffle" is an Atari computer version of "Magic Square," the game where you slide the little numbered squares around until you get them in order. "Space Invasion," for the C1P/Superboard and "Shootdown" are arcade-style action games. Finally, "23 Matches" is a short machine-language game for the SYM. It makes ingenious use of the SYM's LCD display.

This month's editorial (p. 7) offers some thoughts on games and their place in MICRO and in our society.

68000 Coverage Continues

Preliminary results from our survey indicate that a lot of you are interested in the 68000. As part of our continuing effort to keep you informed on this powerful new pro-

cessor, we present two articles this month on the 68000. Dr. Hootman's detailed discussion of the 68000 instruction set continues (p. 27) with the binary arithmetic operations. Handy reference tables are included. Jelemensky and Whiteside (p. 13) conclude their demonstration of 68000 programming techniques.

We haven't seen any games yet for the 68000. Is it because its users haven't gotten over the speed and power? Or is it because these machines aren't finding their way into very many homes?

Atari Coverage Takes Off

With the addition of Contributing Editor Paul Swanson to our staff, MICRO's Atari coverage has improved considerably. Paul's column, a new "From Here to Atari" (p. 103), starts this month. In addition, he continues his character graphics article series with a discussion of fine scrolling (p. 82). This month's data sheet (p. 109 — compiled by Paul Swanson) is a handy reference for serious Atari programmers.

Atari users will be interested in programming extra colors, even in the limited high-resolution modes. Richard and Donna Marmon (p. 96) illustrate two techniques — one that uses adjacent color dots, and one that quickly alternates displays.

Hardware

In keeping with our lighter theme in this issue, the hardware articles we present are simple, single-evening projects. All involve modifications of existing equipment. Ralph Tenny (p. 19) shows how to get a high-quality picture from your color computer using a monitor instead of a TV. A monitor requires a composite video signal, not available on the CC, and the author shows you how to add it. Jim Strasma (p. 35) shows how to take Commodore's cheapest model PET and convert it into a machine with 80-column business capabilities, yet with all the graphic characters still available from the keyboard. OSI owners can now use Atari's inexpensive joysticks with their machines. Joseph Ennis (p. 9) shows how to make the simple changes in your computer board.

Graphics for the Apple

For those interested in improving their game and graphic programming skills, our graphics articles for Atari and Apple will help. Apple programmers will learn about 3-D rotation from Chris Williams (p. 99). If you have done much graphics programming on the Apple, you have probably been annoyed by the unfortunate location of the graphics pages. Authors Berns (p. 93) and Weston (p. 79) present a number of techniques to circumvent this problem.

New Color Computer Column Expands 6809 Coverage

John Steiner's new monthly column "CoCo Bits" covers the 6809-based TRS-80 Color Computer (p. 38). This month he discusses some problems associated with transferring cassette programs to disk and presents a short program to move the game "BEDLAM." Also for the Color Computer owner, Ron Anderson discusses FLEX09 (p. 23) as it is implemented by Frank Hogg Laboratories. FLEX is a universal operating system that opens up a wide range of software for the 6800 and 6809 to the Color Computer owner.

MICRO

Emulates these terminals exactly.

IBM 3101
DEC VT100, VT52
Data General D200
ADD5 Regent 20, 25, 40
Hazeltine 1400, 1410, 1500
Lear Siegler ADM-3A, ADM-5
TeleVideo 910
Teletype Model 33 KSR

Apple is a trademark of
Apple Computer, Inc.

New File Transfer Language

SOFTERM

High-speed
CRT Look-alike Software
for Your Apple

NOW
\$150
30-DAY MONEY BACK
GUARANTEE

SEE SOFTERM AT
APPLEFEST/SAN FRANCISCO
BOOTH #121

SOFTRONICS

BREAK
CATALOG
CHAIN
CONFIGURE
CONNECT
CONVERSE
DIAL
END
HANGUP
LOG
MONITOR
NOLOG
ONERR
PAUSE
PROMPT
RECEIVE
REMARK
RETRIES
SEND
SPECIAL
SPEED
TIMEOUT
XMIT:WAIT

Supports these
interface boards.

Apple Communications Card
Apple Parallel Printer
Apple Serial Interface
Apple Super Serial Card
Bit 3 Dual-Comm Plus™
CCS 7710, 7720, 7728
Hayes Micromodem II™,
Smartmodem™ 300, & 1200
Intra Computer PS10
Novation Apple-Cat II™ 300 & 1200
Orange Micro Grappler™
SSM ASIO, APIO, AIO, AIO II™

Supports your 80-column hardware.

ALS Smarterm™
Bit 3 Full-view 80™
Computer Stop Omnivision™
M&R Sup'R'Terminal™
STB Systems STB-80™
Videx Videoterm™
Vista Computer Vision 80™
Wesper Micro Wizard 80™



specify the serial interface parameters
to be used.

Your host computer won't know the difference!

Softerm provides an exact terminal emulation for a wide range of CRT terminals which interface to a variety of host computer systems. Special function keys, sophisticated editing features, even local printer capabilities of the terminals emulated by Softerm are fully supported. Softerm operates with even the most discriminating host computer applications including video editors. And at speeds up to 9600 baud using either a direct connection or any standard communications modem.

Unmatched file transfer capability

Softerm offers file transfer methods flexible enough to match any host computer requirement. These include *character protocol* with user-definable terminator and acknowledge strings, block size, and character echo wait, and the intelligent *Softtrans™* protocol which provides reliable error-free transmission and reception of data. The character protocol provides maximum flexibility for text file transfers. Any type file may be transferred using the Softtrans protocol which provides automatic binary encoding and decoding, block checking with error recovery, and data compression to enhance line utilization. A FORTRAN 77 source program is supplied with Softerm which is easily adaptable to any host

computer to allow communications with Softerm using the Softtrans protocol.

Softerm file transfer utilizes an easy to use *command language* which allows simple definition of even complex multiple-file transfers with handshaking. Twenty-three high-level commands include *DIAL, CATALOG, SEND, RECEIVE, ONERR, HANGUP, MONITOR* and others which may be executed in immediate command mode interactively or from a file transfer macro command file which has been previously entered and saved on disk.

Built-in utilities

Softerm disk utilities allow DOS commands such as *CATALOG, INIT, RENAME, and DELETE* to be executed allowing convenient file maintenance. Local file transfers allow files to be displayed, printed, or even copied to another file without exiting the Softerm program. Numerous editing options such as tab expansion and space compression are provided to allow easy reformatting of data to accommodate the variations in data formats used by host computers. Softerm supports automatic dialing in both terminal and file transfer modes. Dial utilities allow a *phone book* of frequently used numbers to be defined which are accessed by a user-assignable name and

Online Update Service

The Softronics Online Update Service is provided as an additional support service at no additional cost to Softerm users. Its purpose is to allow fast turnaround of Softerm program fixes for user-reported problems using the *automatic patch facility* included in Softerm as well as a convenient distribution method for additional terminal emulations and I/O drivers which become available. *User correspondence* can be electronically mailed to Softronics, and *user-contributed* keyboard macros, file transfer macros, and host adaptations of the Softtrans FORTRAN 77 program are available on-line.

Most advanced communications software available

Just check Softerm's 300 page user manual. You simply can't buy a more sophisticated package or one that's easier to use. Available now for only \$150 from your local dealer or Softronics, Inc.

SOFTRONICS
6626 Prince Edward, Memphis, TN 38119. 901-755-5006

MICRO™

THE 6502/6809 JOURNAL

STAFF

President/Editor-in-Chief
ROBERT M. TRIPP

Publisher
MARY GRACE SMITH

Editorial Staff
PHIL DALEY — Technical editor
JOHN HEDDERMAN — Jr. programmer
MARJORIE MORSE — Editor
JOAN WITHAM — Editorial assistant
LOREN WRIGHT — Technical editor

Graphics Department
HELEN BETZ — Director
PAULA M. KRAMER — Production mgr.
EMMALYN H. BENTLEY — Typesetter

Sales and Marketing
CATHI BLAND — Advertising mgr.
CAROL A. STARK — Circulation mgr.
LINDA HENS DILL — Dealer sales
MAUREEN DUBE — Promotion

Accounting Department
DONNA M. TRIPP — Comptroller
KAY COLLINS — Bookkeeper
EILEEN ENOS — Bookkeeper

Contributing Editors
DAVE MALMBERG
JOHN STEINER
JIM STRASMA
PAUL SWANSON
RICHARD VILE

Advertising Sales Representatives
See Page 127

Subscription/Dealer inquiries
(617) 256-5515

DEPARTMENTS

- 3 November Highlights
- 7 Editorial
- 38 CoCo Bits
- 50 New Publications
- 63 Letters/Updates
- 75 PET Vet
- 86 APPLE Slices
- 88 Reviews in Brief
- 103 From Here to ATARI
- 105 6809 Bibliography
- 106 Software Catalog
- 108 Hardware Catalog
- 109 Data Sheet
- 111 Advertiser's Index
- 112 Next Month in MICRO

GAMES FEATURE

- 41 Castle Adventure for PET and APPLE..... *David Malmberg*
- 49 SYM 23 Matches..... *Matt Ganis*
- 53 Solve the Pagoda Puzzle Using Recursive Assembly..... *Sherwood Hoyt*
- 59 VIC/PET GOMOKU..... *David Malmberg*
- 62 Number Shuffle on the ATARI..... *Frank Roberts*
- 66 Sensible Use of APPLE Game Paddles..... *Harry L. Pruetz*
- 70 Space Invasion for OSI C1P/Superboard..... *John S. Seybold*
- 72 APPLE Shutdown..... *Eric Grammer*

HARDWARE

- 9 ATARI Joysticks on the OSI..... *Joseph Ennis*
A simple modification including software and programming information
- 13 An MC68000 Overview, Part 2..... *Joe Jelemsky and Tom Whiteside*
Simple examples illustrate 68000 programming techniques
- 19 A Monitor for the TRS-80 Color Computer..... *Ralph Tenny*
Instructions to get composite video from the video section of the CC
- 23 FLEX and the TRS-80 Color Computer..... *Ronald W. Anderson*
A description of FLEX09
- 27 68000 Binary Arithmetic Operations..... *Joe Hootman*
A discussion of binary arithmetic instructions
- 35 How to Make a Graphic-80 PET from a 4016..... *Jim Strasma*
Just add inexpensive ICs and move jumpers

GRAPHICS

- 79 APPLE Hi-Res Graphics and Memory Use..... *Dan Weston*
Avoid overwriting the graphic display area
- 82 ATARI Character Graphics from BASIC, Part 2..... *Paul Swanson*
Learn about fine scrolling
- 93 Getting Around the APPLE Hi-Res Graphics Page..... *Eagle I. Berns*
Utilize the graphics area without sacrificing memory
- 96 Extra Colors for the ATARI..... *Richard I. and Donna Marmon*
Two techniques to expand your computer's palette
- 99 Introduction to 3-D Rotation on the APPLE..... *Chris Williams*
Learn the techniques for yaw, pitch, and roll

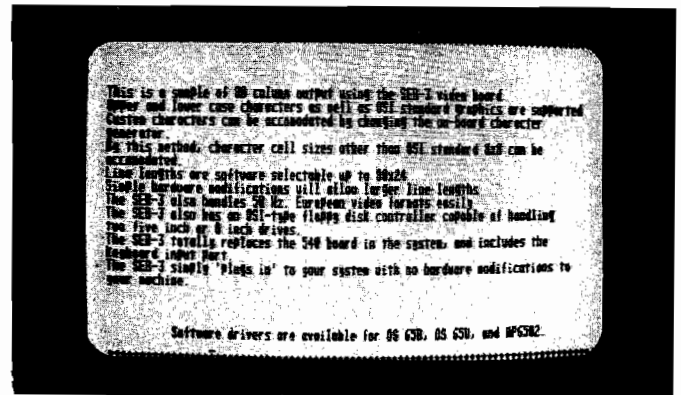
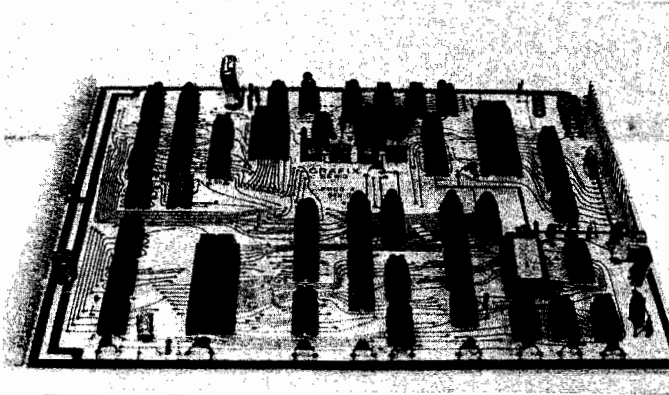

SUPER OSI EXPANSION BOARDS

Tired of trying to run your word processor or your DMB on an OSI 64 character video screen? Now there's the SEB-3, THE most versatile 80x24 video board anywhere is available for OSI 48 pin BUSS systems. No longer will you have to consider converting your video-based system to a serial terminal because you've found 64 characters stifling for serious business use. Nor need you give up compatibility with any existing graphics software because the SEB-3 allows you to choose ANY screen format up to 80x24 including 32x32 and 64x32. Since the SEB-3's screen format can be changed at any time under software control, even gaming displays can benefit from screens custom tailored to the game itself. The SEB-3 is so well designed and so versatile that it will not need to be replaced — ever. Simple changes in software and/or hardware will allow the SEB-3 to: generate displays up to 256

columns; handle 50 Hz European formats; accommodate custom characters or character cell sizes larger or smaller than 8x8 and transparently access the screen to eliminate screen "glitches". In short, the SEB-3 will meet any demands your system may place on it now and in the future. The SEB-3 also supports an OSI-style floppy disk interface which can handle two 5" or 8" drives. Like all of the boards in the SEB series, the SEB-3 simply "plugs in" to your machine — there are absolutely NO hardware changes. The SEB-3 is designed to replace your outmoded 540 board so you don't even lose a backplane slot. Your keyboard input now also plugs into the SEB-3 — load one of the software drivers and you're ready to go!

SEB-3 Assembled \$259.00
Kit \$220.00

Bare Board \$59.00
Manual only \$5.00

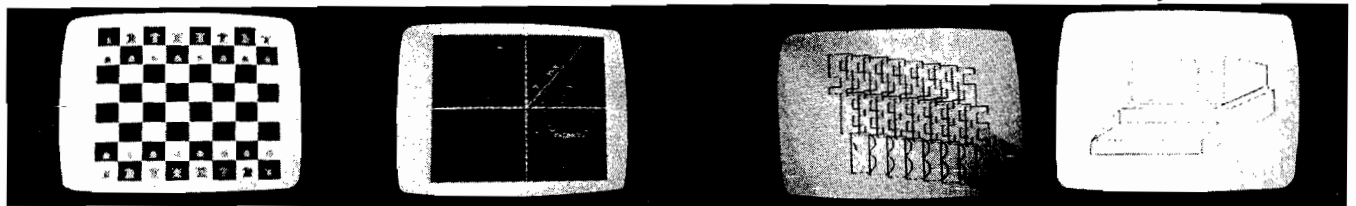

If your Challenger can't generate displays like those shown above **WHAT ARE YOU WAITING FOR?** The SEB-1 High Resolution Graphics and Memory Board (for C1P and Superboard II) and the SEB-2 High Resolution Graphics and Disk Controller Board (for C2/4/8) simply 'plug-in' to your computer and give you instant access to over 49000 individually addressable pixels in up to 8 colors! Your Hi-Res screen can go from 32 x 16 alphanumerics to 256 x 192 point graphics in 11 software selectable modes. The standard video of your computer is left intact, so that none of your current software library is outmoded. Use the graphics for Business, Scientific, Education, or Gaming displays that were impossible — until now!

Installation of either board requires absolutely NO modification of your computer—they just 'plug-in'. Nor do they preclude your using any other OSI-compatible hardware or software. In addition to the Hi-Res Graphics the SEB-1 gives C1 & Superboard II users 16K of additional user memory (over and above that memory devoted to the graphics), two 16 bit timers/counters, an on-board RF modulator, and a parallel port with handshaking. The SEB-2 gives OSI 48-pin BUS users an OSI hardware/software compatible Disk controller, and an RF modulator that can be user-populated.

FOR OSI 1P, 2-4P, 2-8P, C4P, C8P

	SEB-1	SEB-2
Assembled and Tested	\$249.00 (5K RAM)	\$239.00 (1K RAM)
Kit	\$165.00 (No RAM)	\$199.00 (No RAM)

	SEB-1	SEB-2
Bare Board & Manual	\$ 59.00	\$ 59.00
Manual only	\$ 5.00	\$ 5.00

COMING: SEB-3 80 x 24 Video/Disk Controller (C2/4/8), SEB-4 48K Memory RAM/ROM (C2/4/8), SEB-5 8K RAM/Disk/Sound/Clock/Voice (C1 & Superboard).

Write for **FREE** catalog
International Requests please
supply 2 International Response Coupons

ORION



SOFTWARE ASSOC.

P.O. BOX 310, OSSINING, NY 10562



914-762-5636

About the Cover



Our brave knight, Godfrey de Goodheart, boldly chases dragons through Baron Von Evil's castle in search of the fair Princess Fatima. MICRO features "Castle Adventure" by David Malmberg (page 41). It is written for PET, Apple, and other Microsoft BASIC computers.

The photo, by Kenneth Witham, is of Schloss Anif in Salzburg, Austria. The knight and dragon graphics were drawn on the Apple Graphics Tablet.

MICRO is published monthly by:
MICRO INK, Chelmsford, MA 01824
Second Class postage paid at:
Chelmsford, MA 01824 and additional
mailing offices
USPS Publication Number: 483470
ISSN: 0271-9002

Send subscriptions, change of address, USPS
Form 3579, requests for back issues and all
other fulfillment questions to

MICRO INK
34 Chelmsford Street
P.O. Box 6502
Chelmsford, MA 01824
or call
617/256-5515
Telex: 955329 TLX SRVC
800-227-1617

Subscription Rates	Per Year
U.S.	\$24.00
	2 yr. / \$42.00
Foreign surface mail	\$27.00
Air mail:	
Europe	\$42.00
Mexico, Central America, Middle East, North Africa, Central Africa	\$48.00
South America, South Africa, Far East, Australasia, New Zealand	\$72.00

Copyright© 1982 by MICRO INK
All Rights Reserved

MICRO™

Editorial

Responsible Gamesmanship

MICRO does not publish games. We've run editorials explaining why — outlining the weaknesses, drawbacks, and worthlessness of many computer games. The computer was not developed to fill arcades or to force squeals of delight or anguish from mesmerized users who've spent hours killing the same aliens over and over again.

So why have we not only added games in this issue, but FEATURED them? We aren't giving in; we still believe many games are a waste of time. But we also believe that games — when written and presented properly — can educate. In fact, they can act as an effective tool at all educational levels.

For example, there are games that simulate business environments, games that demand logical thought, games that teach us how to program, how to spell, or to calculate mathematical equations. The variations of these games that are most successful actively involve the student/participant in problem solving and decision making. They are not just drills to enable us to push the right button at the right time or to give the right answer; they are lessons in learning — they can expand our understanding of both artificial and human intelligence.

You see, it's the games that just pit one person against the computer in a mindless battle of eye-hand coordination that irritate us the most. [Does an image of your neighborhood's favorite arcade leap to mind?] Maybe these florescent, noisy battlegrounds provide entertainment for those who need to let off a little steam; but to have energetic, lively, questioning children and adolescents glued to machines in meaningless combat for hours on end is scary.

Whose responsibility is it (yours, ours, the schools, the manufacturers) to offer at least enough of the really worthwhile stuff to balance off what's already so, unfortunately, popular?

Judah Schwartz, Professor of Engineering Science and Education at MIT, summed up the software situation in a recent issue of *Classroom Computer News*. Although his comments were directed specifically toward educational material, they can be as easily applied to games in general: "My hope is that the publishers of this country — who control the curriculum far more than they even begin to realize — will stop doing what they are now doing and start to provide materials for computers which are more open-ended, which are more tool-like in nature, which will help children to assume a more active role, which will not trivialize the nature of education, and which will work to make schools more nearly the collaborative community of learners that they should be."

Computers are efficient, friendly, and generally expensive. As with everything else, we want them to be used to their full potential. One way is through well-written, mind-boggling, educational games. So, MICRO would like to promote the use of these types of games. We encourage manufacturers to continue to produce quality products that get the most out of the computer and the participant. We encourage publishers of books and magazines to support the use of stimulating games that require both the use of skill and the growth of skills.

We hope you enjoy the games we present in this issue, but also hope you will learn some new techniques and some good methods for writing your own games. We hope you will give some thought to the social impact of computer games, as well.

Micro Staff

Amper-MagicTM

**MACHINE LANGUAGE SPEED
WHERE IT COUNTS...
IN YOUR PROGRAM!**

For the first time, Amper-Magic makes it easy for people who don't know machine language to use its power! Now you can attach slick, finished machine language routines to your Applesoft programs in seconds! And interface them by name, not by address!

You simply give each routine a name of your choice, perform the append procedure once at about 15 seconds per routine, and the machine language becomes a permanent part of your BASIC program. (Of course, you can remove it if you want to.)

Up to 255 relocatable machine language routines can be attached to a BASIC program and then called by name. We supply some 20 routines on this disk. More can be entered from magazines. And more library disks are in the works.

These routines and more can be attached and accessed easily. For example, to allow the typing of commas and colons in a response (not normally allowed in Applesoft), you just attach the Input Anything routine and put this line in your program:

```
xxx PRINT "PLEASE ENTER THE DATE."; : & INPUT,DATES
```

&-MAGIC makes it Easy to be Fast & Flexible!

PRICE: \$75

&-Magic and Amper-Magic are trademarks of Anthro-Digital, Inc. Applesoft is a trademark of Apple Computer, Inc.

Some routines on this disk are:

- Binary file info
- Delete array
- Disassemble memory
- Dump variables
- Find substring
- Get 2-byte values
- Gosub to variable
- Goto to variable
- Hex memory dump
- Input anything
- Move memory
- Multiple poke decimal
- Multiple poke hex
- Print w/o word break
- Restore special data
- Speed up Applesoft
- Speed restore
- Store 2-byte values
- Swap variables

Anthro - Digital Software

P.O. Box 1385

Pittsfield, MA 01202

The People - Computers Connection

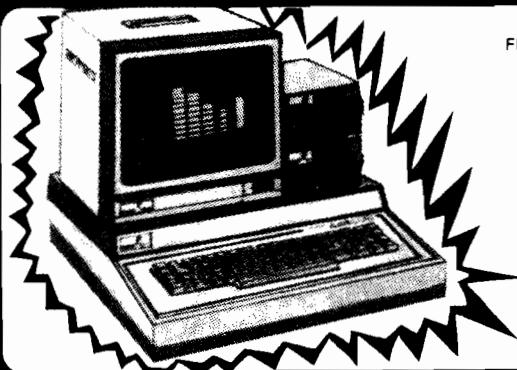

FRANKLIN

ACE 100

ENTIRE SYSTEM

1995⁰⁰

ACE 100 64K 2 RANA DRIVES

12" NEC GREEN SCREEN MONITOR

VOICE SYNTHESIZER FOR AIM/SYM/KIM WITH SPEAKER \$139.00
 AIM 65, 4K, COMPLETE WITH MANUALS \$469.00

NEW FULLY GUARANTEED PARTS			
6502P, 1 MHZ	\$ 5.95	555 TIMER	\$.39
6512P, 1 MHZ	5.95	XR2206	4.95
6520P, PIA	4.45	XR2211	4.95
6522P, VIA	6.45	DM8131	3.45
6532P, RIOT	7.95	RED L.E.D., 1 1/4", HI EFF.	.15
6545-1P, CRT	19.95	IN4004	.09
6551P, UART	8.95	IN914	.04
6592P, PRINT CTRL.	26.80	IN4148	.04
6847P, VDG	15.60	8 POSITION DIP SWITCH	4.95
		2114, 1Kx4, 450NS.	\$ 2.25
		6116, 2Kx8, CMOS	7.50
		4116, 16Kx1, DYNAMIC	1.95
		4164, 64Kx1, DYNAMIC	10.95
		2716, 2Kx8	3.95
		2532, 4Kx8	8.50
		4N33, OPTO-COUPLER	2.95
		VOLTRAX SC-01A	69.00

PHONE ORDERS WELCOME - FREE CATALOG - HOURS 9 A.M. TO 5 P.M. CST.

CASHIERS CHECK or MONEY ORDER
 PERSONNEL CHECKS, 2 WEEKS WITH D.L.#
 MC or VISA, MUST HAVE CARD NO.
 SHIPPED VIA U.P.S. or 1st CLASS MAIL
 C.O.D. ACCEPTED, ADD \$5.00
 MAIL ORDER ONLY



ADD \$1.75 FOR U.P.S.
 ADD \$2.75 for 1st CLASS MAIL
 ADD ADDITIONAL \$5.00 FOR C.O.D.
 ADD ADDITIONAL \$3.75 FOR OUT OF U.S.
 TEXAS RESIDENTS ADD 5% SALES TAX
 PRICES GOOD THROUGH DECEMBER 31, 1982

BEDFORD MICRO SYSTEMS 817 - 283-0013

P.O. BOX 1182 BEDFORD, TEXAS 76021

Installing Atari Joysticks on the OSI

by Joseph Ennis

A simple, non-destructive modification to the OSI C1P or Superboard is described. This allows the use of inexpensive Atari joysticks. Demonstration software and programming information are also included.

Joystick requires:

- C1P
- Hardware components
- One or two Atari joysticks

Molex connector according to the following table:

Molex Pin	Joystick 1	Joystick 2
1	—	Black
2	Black	—
3	—	—
4	—	—
5	Green	Green
6	Blue	Blue
7	Brown	Brown
8	White	White
9	Orange	Orange
10	—	—
11	—	—
12	—	—

joystick connector into J4, the connector in the lower left corner or closest to the keyboard (see photograph). Plug in the joystick connector so that pin 1, the one with a black wire on it, is toward the back of the 600 board (away from the keyboard). Bring up power and, without touching the joystick, check to see that the keyboard works as before. Now pick up joystick 1, the one with its black wire connected to pin 2. Move the controls on the joystick and note that characters are printed to the monitor screen according to the following table. Pick up joystick 2 and perform the same test. Any problem is most likely a soldering problem.

	Joystick 1	Joystick 2
Fire	Q	1
Up	A	2
Right	Z	3
Down	Space	4
Left	/	5

Don't worry about Up-Right or Up-

Installing Atari joysticks on the OSI 600 board-based computers (Superboard or C1P) is easy. It takes \$9.95 per joystick and five minutes.

Sears is a good source for Atari joysticks; they stock them under two catalog numbers — 6K99835 for a single joystick or T3K7687 for a pair. You'll pay \$19.95 for two. In addition you will need one 12-pin male Molex connector. You may purchase one from your OSI dealer for \$1.00, or from Technical Products Co., Box 12983, University Station, Gainesville, FL 32604 (Molex connectors are \$4.95 for four pair of male and female).

My 600 board came without J4 mounted, but it took me about one minute to push a connector into the holes in the printed wiring board and solder the twelve pins to the board.

When you get the joysticks, cut the Atari cables as close to the connector as possible, and strip enough of each wire to connect to a male Molex connector (about 1/8 inch). I used a drill press vise to hold the Molex connector and an X2 magnifying glass to aid in soldering. I also used the trick of wrapping several turns of number 18 buss wire around the tip of my 15-watt pencil iron to give me a fine soldering point.

Solder the wires of both joysticks (if you plan to use two) to the single male

For those interested in how this modification works, figure 1 shows the schematic of the 600 board keyboard area with the joysticks connected to connector J4.

Testing is also easy. First do the usual inspection for poor workmanship, solder bridges, etc. Then plug the

Figure 1: Keyboard/Joystick Schematic

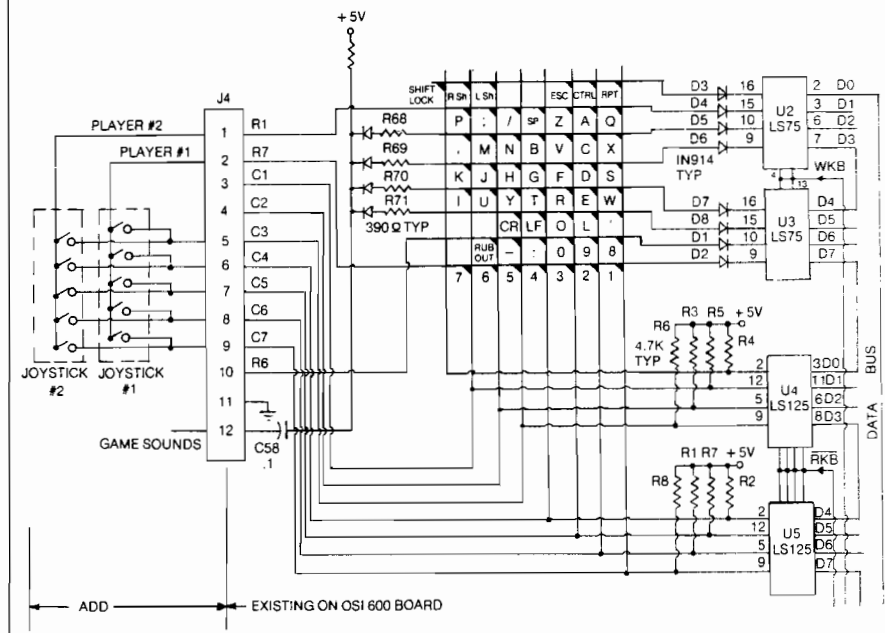

Right-While-Firing. These combinations are there, but right now they decode to non-printable symbols and don't show on the monitor screen.

This completes installation and testing. The rest of the joystick operation is software. At the time of this writing OSI had not yet come out with any joystick programs for the 600 board computers, so there had not been any standardization of the joystick move/decode tables. Much joystick software for the OSI is sold by Aardvark Technical Services, 2352 South Commerce, Walled Lake, MI 48088. Aardvark uses a slightly different method of connecting joysticks and a different decode. There are advantages and disadvantages. Aardvark's Mod is longer and requires cutting some traces on the 600 board. However, they have a lot of good software already developed according to their convention. Fortunately, the difference is not great. Joystick 2 in this mod has the same decode as joystick 1 in the Aardvark mod. Therefore, all one-player games need no changes. Aardvark's joystick 2 is connected so that it decodes to: Fire=8 Up=9 Right=0 Down=: and Left=-. For two-player Aardvark games the code must be changed.

When writing software for joysticks, the following line must appear early in the program:

```
POKE 530,1 :REM TURNS OFF KEYBOARD SCAN, POKE 530,0 WILL TURN KEYBOARD SCAN ON AGAIN
```

Later in the program, when joystick 1 is to be polled, program:

```
POKE 57088,128: P = PEEK(57088)
```

and when joystick 2 is to be polled, program:

```
POKE 57088,2: P = PEEK(57088)
```

Table 1 gives all the possible values for variable P.

A joystick demo program has been included at the end of this article. This demo illustrates most of the techniques for animated graphics and their use with joysticks.

This program, when running, will display two tank symbols. Each tank symbol will be controlled by one joystick. A study of listing 1 will illustrate the programming techniques required by programs using joystick inputs. It is not necessary to have a joystick decode table with all seventeen of the entries given in table 1, since FIRING is merely the position values, less 127. Therefore, note that in line 70 FIRE is set equal to 128 and in line 1000 P is checked to see that it is less than FIRE. If it is, then the program jumps to the FIRE subroutine at 2000. The last

Listing 1

```
0 REM*****
1 REM JOYSTICK **
2 REM DOODLER **
3 REM **
4 REM by **
5 REM Joseph Ennis **
6 REM **
7 REM A DEMO of JOY-**
8 REMSTICK TECHNIQUES*
9 REM*****
10 REM JOYSTICK ONE IS SET AT 1=FIRE, 2=UP, 3=DOWN, 4=LEFT
11 REM JOYSTICK TWO IS SET AT Q=FIRE, A=UP, Z=RIGHT, SPACE=DOWN, /=LEF
12 REM YOU WILL NOTE SOME INTERACTION PROBLEMS WITH BOTH FIRE BOTTONS
13 REM SET TO COLUMN 7 THIS CAN BE FIXED BY SETTING FIRE ON
14 REM JOYSTICK TWO TO FIRE=? AND MAKING A FEW CHANGES IN FIRE SUBROUT
15 DIM K(8), M(8), S(8)
20 X=0: U=0
30 FOR X=1 TO 8: READ K(X): NEXT: REM LOADS KEY DECODE TABLE
40 FOR X=1 TO 8: READ M(X): NEXT: REM LOADS MOVE TABLE
50 FOR X=1 TO 8: READ S(X): NEXT: REM LOADS SYMBOL TABLE
60 A=53480: B=54061: REM TANK A&B START LOCATIONS
70 AA=2: BB=128: NOOP=254: FIRE=128: C=57088: SHELL=46: BLANK=32
71 REM FIRE REALLY EQUALS 127 BUT SETTING TO 128 SAVES AT 1000 & 2110
74 FOR X=1 TO 32: PRINT: NEXT
75 INPUT"SELECT SPEED (1=FAST 200=SLOW)":DELAY
90 FOR X=1 TO 32: PRINT: NEXT: REM SLOW SCREEN CLEAR
100 POKE 530,1: REM TURN OFF AUTOMATIC KEYBOARD SCAN
110 POKE A,S(4): POKE B,S(8): REM INITIALIZE TANK LOCATIONS
120 POKE C,AA: P=PEEK(C): IF P<NOOP THEN F=2: GOTO 1000
130 POKE C,BB: P=PEEK(C): IF P<NOOP THEN F=3: GOTO 1000
140 GOTO 120: REM LOOP WAITS FOR JOYSTICK MOVEMENT
200 DATA 190, 158, 222, 206, 239, 230, 246, 182
210 DATA -32, -31, +01, +33, +32, +31, -01, -33
220 DATA 248, 249, 250, 251, 252, 253, 254, 255
990 REM MOVEMENT SUBROUTINE STARTS ON 1000
1000 IF P<FIRE THEN GOSUB 2000
1005 IF P=NOOP THEN GOTO1050
1010 FOR X=1 TO 8
1020 IF K(X)=P THEN MOVE=M(X): SYMBOL=S(X): X=8: REM SETS UP FOR MOVE
1025 NEXT X
1030 IF F=2 THEN POKE A,BLANK: A=A+MOVE: POKE A,SYMBOL: REM CLASSIC MOV
1040 IF F=3 THEN POKE B,BLANK: B=B+MOVE: POKE B,SYMBOL: REM MOVE B
1045 FOR X=1 TO DELAY: Z=2: NEXT X
1050 ON F GOTO 1000,130,120: REM LOOPS BACK TO JOYSTICK DET LINES
1990 REM FIRE DECODE SUBROUTINE STARTS ON 2000
2000 REM FIRE DECODE SUBROUTINE
2005 IF F=2 THEN SYMBOL=PEEK(A): L=A: REM GUN NEEDS TO KNOW WAY TANK F
2010 IF F=3 THEN SYMBOL=PEEK(B): L=B: REM WAY TANK B FACES
2020 FOR X=1 TO 8
2030 IF S(X)=SYMBOL THEN W=X: L=L+M(W): X=8
2035 NEXT X
2040 FOR U=1 TO 10*RAND(X): REM MOVE SHELL, JUST EFFECTS NO ATTEMPT TO
2050 POKE L,SHELL: V=1: POKE L,BLANK: L=L+M(W)
2060 NEXT U
2070 FOR U=1 TO 10
2080 POKE L,INT(100*RAND(X)): REM A LITTLE EXPLOSION AT END OF SHELL FL
2090 NEXT U
2100 POKE L,BLANK: REM CLEANS UP LAST OF EXPLOSION
2110 P=P+FIRE
2120 RETURN
```

line in the FIRE subroutine adds 127 back to P, taking out the effect of FIRE before turning control over to the MOVE loop. This halves the time of the loop and the size of the joystick decode table, as only eight values are needed for two joysticks. This still allows the players to move while firing.

There is one disadvantage with the technique used in this joystick mod. When two players are playing and both players are moving their joysticks at the same time, there are combinations where there can be feedback through the joystick switches. With the keyboard polling routine that OSI uses, one data line at a time is set on the LS75 latches, U2 and U3 [see figure 1]. When

one latch (these are inverting latches) is set it pulls down the line to one of the rows of keys on the keyboard. If any key in that row is pushed, its position will be read by the LS125 bus drivers. This is why a PEEK to the keyboard address will return the value of 255 (all ones) when no keys are pushed. When only one of the LS75 latch stages is energized, then only one row is set for decode.

Pushing a key in any other row will not produce any output on the data bus. This is why selecting one joystick to row 1 and the other to row 7 will allow one joystick to be decoded independently of the other, even though they are connected to the same columns.

Table 1

Joystick Position	Value of P	Movement Value
Not FIRING and:		Current Position plus
Up	190	- 32
Up/Right	158	- 31
Right	222	+ 01
Down/Right	206	+ 33
Down	238	+ 32
Down/Left	230	+ 31
Left	246	- 01
Left/Up	182	- 33
FIRING and:		
No movement	127	+ 00
Up	063	- 32
Up/Right	031	- 31
Right	095	+ 01
Down/Right	079	+ 33
Down	111	+ 32
Down/Left	103	+ 31
Left	119	- 01
Left/Up	055	- 33

When the computer wants to check joystick 1 for movement, a 128 is POKEd into the keyboard address (polling must be suppressed at this time by the POKE 530,1 having already been executed) and only a key closure in row 1 will

produce an output on the data bus. It is connected to the only low latch; all the rest are high. As long as 128 has been POKEd to the keyboard address, only a movement of joystick 1 can be read. If joystick 1 is not being moved, then no movement of joystick 2 will produce any output on the data bus. The same thing happens when the computer wants to read joystick 2; a 2 is POKEd to the keyboard address, which allows only the keys in row 7 to be active. No other keys will produce any output on the data bus. The only problem occurs when both joysticks are being moved at the same time. The worse case is when one is moving and firing and the other is only firing. The low set by the latch will feed through the two fire switches and be read as a movement by the bus driver when only a fire was intended. This can really destroy a game. Putting another isolating diode in any of the joystick lines doesn't help, as the LS125's are too sensitive. They see the forward voltage drop of the two diodes in series (one of the diodes D1 through D8 with any additional isolating diode), which causes the LS125 to always stay high. No key closures are detected. A pull-down resistor to a negative supply in conjunction with

the isolating diode would be a solution. Another solution is a hearing aid battery in series with the joystick's isolating diode. Or you could just give up the option of moving while firing. I use a software solution which, while not perfect, has yet to produce any objectional performance in any of the games I am running. Move the orange wire on joystick 1 from pin 9 to pin 4 and make the following software changes: define a new variable in demo program line 70 like FO=251, and rewrite line 1000 as 1000 IF FIRE < P OR (P AND FO) THEN GOSUB 2000. This way the FIRE push buttons are connected to separate columns and can't feed back through each other's switches. Movements are now only slightly affected. If one joystick is doing Up/Right and the other is doing Up, then both will do Up/Right. But if one is doing Up/Right and the other is doing Up/Left or anything besides pure Up, then both will move their separate ways. In an actual game, this fix is sufficient.

You may contact Mr. Ennis at 212 20 St., Niceville, FL 32578.



OSI

Stankiewicz & Robinson,
authors of MINOS, NIGHT RIDER, etc.,
proudly present to you:

C1P

34 original PROGRAMS on tape all for the unbelievably low price of **\$29.95!!**
That's less than \$1 each!

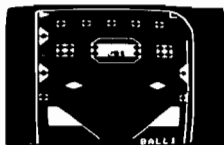

PINBALL

ARCADE TYPE

- NIGHT RIDER*
- COSMIC DEBRIS*
- MINOS*
- STREET SWEEPERS
- RIDGE CRUISER
- CAGE*
- PINBALL
- OSI GRAND*
- MINE FIELD
- WORM
- DEPTH CHARGE
- GOTCHA!

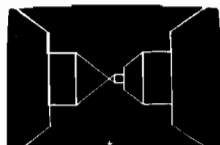

MINOS (MAZE)

STRATEGY

- TAKE FOUR
- MIMIC
- MANCALA
- NEIGHBORS
- BAR
- LIFE FOR TWO*

KALEIDOSCOPIIC

- LIVING PATTERNS
- KALEIDOSCOPE
- DRAW ME



NIGHT RIDER

UTILITIES

- TAPE VERIFIER
- LISTING LINE RE. #
- VERSATILE LINE RE. #
- LINE LOCATOR

STATISTICS

- CHI SQUARE
- FUNCTION PLOTTER
- BETTER RND. # GEN.
- PROBABILITY #1



RIDGE CRUISER

MISCELLANEOUS

- MESSAGE ENCODER
- TYPING TUTOR
- PHONE NUMBER
- DEHYDRATION
- BLACK JACK DRILL

(*Previously sold by AARDVARK™)



Please add \$1.50 postage & handling
PA resident please add 6% sales tax
Charge customers include # and expiration date

VICTORY SOFTWARE CORP.
2027-A S.J. RUSSEL CIRCLE
ELKINS PARK, PA 19117

Sorry, no phone orders on this special deal



DTACK

10

The 68000 DREAM MACHINE

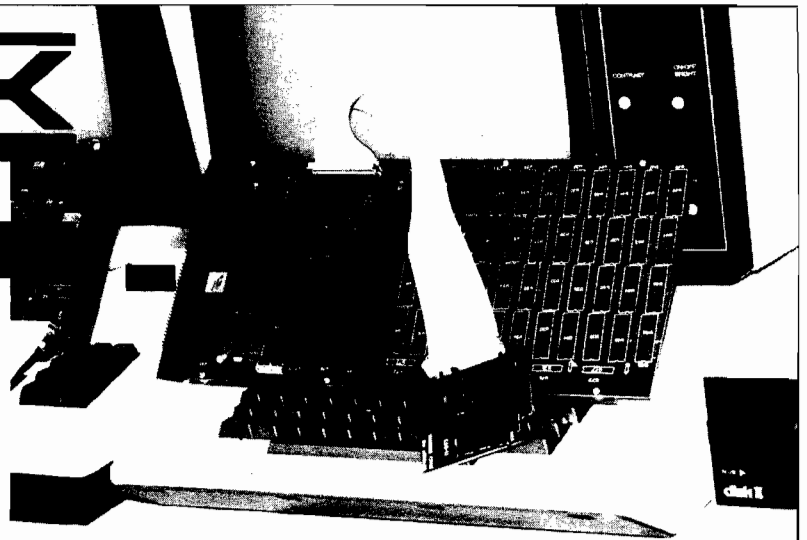

WE (SORT OF) LIED:

Motorola has been promoting its advanced microprocessor chip as a vehicle for large, complex systems **exclusively**. Now, the 68000 does work well as the heart of big, complex systems. But their promotional literature implies that one can **only** build big, complex systems with the 68000, and that is dead wrong (in our opinion). Nevertheless, the public (that's you!) perception of the 68000 follows Motorola's line: **Big** systems. **Complex** systems.

Our boards are **not** complex and not necessarily big (starting at 4K). Our newsletter is subtitled "The Journal of Simple 68000 Systems." But since the public has become conditioned to the 68000 as a vehicle for FORTRAN, UNIX, LISP, PASCAL and SMALLTALK people naturally expect all these with our \$595 (starting price) simple attached processor. **Wrong!**

We wrote our last ad to **understate** the software we have available because we wanted to get rid of all those guys who want to run (multi-user, multi-tasking) UNIX on their Apple II and two floppy disks. Running UNIX using two 143K floppies is, well, absurd. The utilities alone require more than 5 megabytes of hard disk.

HERE'S THE TRUTH:

We **do** have some very useful 68000 utility programs. One of these will provide, in conjunction with a suitable BASIC compiler such as PETSPEED (Pet/CBM) or TASC (Apple II), a five to twelve times speedup of your BASIC program. If you have read a serious compiler review, you will have learned that compilers cannot speed up floating point operations (especially transcendental). Our board, and the utility software we provide, **does** speed up those operations.

Add this line in front of an Applesoft program:

```
5 PRINT CHR$(4);"BLOADUTIL4,A$8600":SYS38383
```

That's all it takes to link our board into Applesoft (assuming you have Applesoft loaded into a 16K RAM card). Now run your program as is for faster number-crunching or compile it to add the benefit of faster "interpretation". Operation with the Pet/CBM is similar.

68000 SOURCE CODE:

For Apple II users only, we provide a nearly full disk of **un-protected** 68000 source code. To use it you will have to have DOS toolkit (\$75) and ASSEM68K (\$95), both available from third parties. Here's what you get:

1) 68000 source code for our Microsoft compatible floating point package, including LOG, EXP, SQR, SIN, COS, TAN, ATN along with the basic four functions. The code is set up to work either linked into BASIC or with our developmental HALGOL language. 85 sectors.

2) 68000 source code for the PROM monitor. 35 sectors.

3) 68000 source code for a very high speed interactive 3-D graphics demo. 115 sectors.

4) 68000 source code for the HALGOL threaded interpreter. Works with the 68000 floating point package. 56 sectors.

5) 6502 source code for the utilities to link into the BASIC floating point routines and utility and debug code to link into the 68000 PROM monitor. 113 sectors.

The above routines almost fill a standard Apple DOS 3.3 floppy. We provide a second disk (very nearly filled) with various utility and demonstration programs.

SWIFTUS MAXIMUS:

Our last advertisement implied that we sold 8MHz boards to hackers and 12.5MHz boards to businesses. That was sort of true because when that ad was written the 12.5MHz 68000 was a very expensive part (list \$332 ea). Motorola has now dropped the price to \$111 and we have adjusted our prices accordingly. So now even hackers can afford a 12.5MHz 68000 board. With, we remind you, **absolutely zero wait states**.

'Swiftus maximus'? Do you know of any other microprocessor based product that can do a 32 bit add in 0.48 microseconds?

AN EDUCATIONAL BOARD?

If you want to learn how to program the 68000 at the assembly language level there is no better way than to have one disk full of demonstration programs and another disk full of machine readable (and user-modifiable) 68000 source code.

Those other 'educational boards' have 4MHz clock signals (even the one promoted as having a 6MHz CPU, honest!) so we'll call them **slow learners**. They do not come with any significant amount of demo or utility software. And they communicate with the host computer via RS 232, 9600 baud max. That's 1K byte/sec. Our board communicates over a parallel port with hardware AND software handshake, at 71K bytes/sec! We'll call those other boards **handicapped learners**.

Our board is definitely not for everyone. But some people find it very, very useful. Which group do you fit into?

DIGITAL ACOUSTICS

1415 E. McFadden, Ste. F

Santa Ana, CA 92705

(714) 835-4884

An MC68000 Overview, Part 2

by Joe Jelemensky and Tom Whiteside

This second part of the 68000 overview provides simple programming examples to illustrate programming techniques and special features of the MC68000. Part 1 appeared in MICRO (52:32).

A Simple MC68000 Subroutine to Compare Two Strings

As a first example of programming the MC68000, consider the string comparison subroutine in figure 1. This simple subroutine will return with the Zero flag set if the first string matches the second. We will use the convention that all strings must be terminated with a zero. Address registers "A0" and "A1" will be used as pointers to the beginning of the two strings to be compared.

The subroutine documentation shows the calling sequence for STRCMP. In the subroutine usage documentation, the string pointers are initialized using the "MOVEA" (MOVE Address) instructions. The ".L" suffix on the MOVEA instructions tells the assembler that a long address is to be moved. A ".W" suffix specifies a sign extended 16-bit word address. In the MC68000, whenever an instruction has two operands, the first operand is the source and the second is the destination. For the first "MOVEA" instruction, "FIRST" is the absolute memory address to be used as a source for the long word to be moved to the destination "A0". Naturally, we can use any of the other addressing modes to specify the string location instead of absolute if we choose to.

After the string pointers are initialized, the user does a "JSR" (Jump to SubRoutine) to the string compare subroutine followed by a branch based on the Z flag. The "BEQ.S" is a branch if equal to zero (string match). The ".S" suffix tells the assembler that the destination is within the range of an 8-bit signed displacement. An ".L" suffix is used for 16-bit displacements.

The STRCMP subroutine begins and ends with "MOVEM.L" instructions to preserve all the registers that are used. The first "MOVEM" (MOVE Multiple) instruction moves the 32-bit contents of "A0" through "A1" and "D0" to the stack, which is pointed at by "A7". The assembler syntax for the register list on a "MOVEM" instruction can be in the form "A0/A1/A2/A3/A4/A5/A6/A7/D0/D1/D2/D3/D4/D5/D6/D7" or the shortened form "A0-A7/D0-D7". The "-{A7}" des-

tinuation means to use the pre-decrement indirect addressing mode with the stack pointer "A7". This is equivalent to pushing the registers onto the system stack. The MC68000 assembler automatically adjusts the number to decrement or increment based on the total size of the operation. The final "MOVEM" instruction does just the opposite and loads "A0" through "A1" and "D0" from the stack using the post-increment indirect addressing mode from "A7". This is

Figure 1: MC68000 String Compare

ROUTINE:	STRCMP --- STRing CoMPare		
PURPOSE:	Compare two strings. If the first string matches the second string then return with the "Z" bit set. The user points A0 at the start of the first string, and A1 at the start of the second.		
ASSUMPTIONS:	Strings terminate in a zero.		
	sample string:	FCC 'this is a string' FCB 00	
EXAMPLES:	First string	Second string	Z bit
	'cattle'	'cattle'	1 match
	'cat'	'cattle'	1 match
	''	'any string'	1 match
	'cattle'	'cat'	0 no match
	'cat'	'fatcat'	0 no match
USAGE:	MOVEA.L FIRST,A0	POINT AT FIRST STRING	
	MOVEA.L SECOND,A1	POINT AT SECOND STRING	
	JSR STRCMP	COMPARE THE STRINGS	
	BEQ.S xxxx	BRANCH IF MATCH IS FOUND	
STRCMP EQU *	*		
	MOVEM.L A0-A1/D0, -(A7)	PRESERVE ALL REGISTERS ON THE STACK	
LOOP EQU *	* EQU * MOVE.B {A0}+,D0 GET THE NEXT CHARACTER IN THE FIRST STRING. IF AT THE END OF THE FIRST THEN IT MATCHES!		
	BEQ.S QUIT		
	CMP.B D0,{A1}+	DOES NEXT CHARACTER IN THE SECOND MATCH? IF IT MATCHES KEEP TRYING. OTHERWISE, FALL THROUGH WITH Z BIT = 0.	
	BEQ.S LOOP		
QUIT EQU *	* EQU * MOVEM.L {A7}+,A0-A1/D0 RESTORE THE REGISTERS AND LEAVE.		
	RTS		

at the assembly-language level and for implementing modern HLLs. Figure 3 shows a typical Pascal procedure and how the procedure call might be implemented in MC68000 code.

Procedure "dojunk" is a typical Pascal procedure with variable parameters "a" and "b" and value parameters "c" and "d". For those unfamiliar with Pascal, a value parameter is a copy of a variable passed to a procedure. This copy can be modified by the procedure but the changes are not passed back to the calling procedure when the procedure exits. Variable parameters, unlike value parameters are passed back to the calling procedure as pointers to the variables. Value parameters are copies of the variables. The MC68000 code for calling procedure dojunk begins by initializing the stack with the procedure parameters. The two "PEA" instructions push the pointers to variables "A" and "B". The two "MOVE" instructions push copies of variables "C" and "D" on the stack. The procedure is then called with the JSR instruction. When the procedure returns to the calling routine, the space made on the stack for the parameters is removed with the ADDQ instruction.

When procedure dojunk (figure 4) is

Figure 4: Stack Usage for Pascal Procedure Call Example

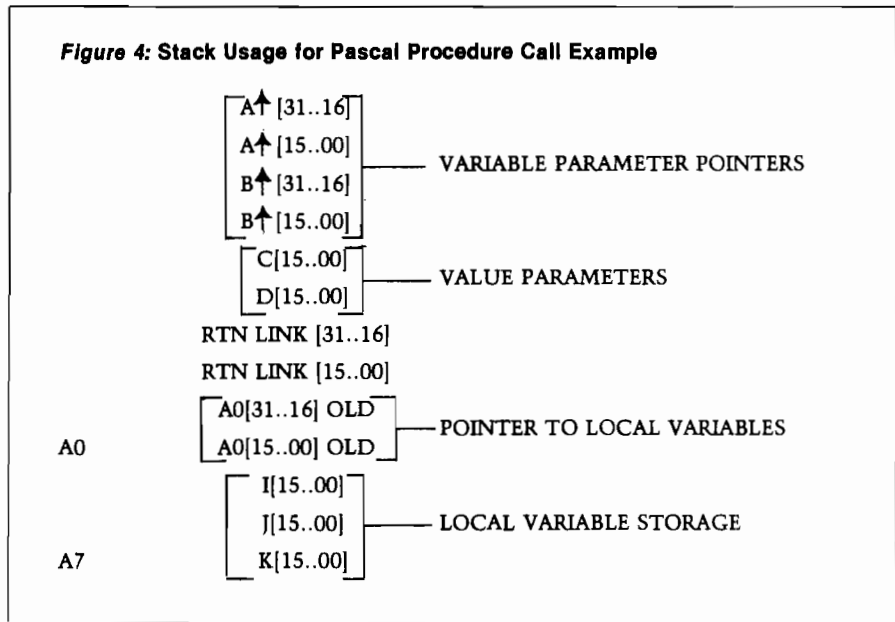

called, the LINK instruction provides a clean way to make room for local variables ("i", "j", "k"). The LINK instruction pushes the old value of "A0" on the stack, sets "A0" equal to the stack pointer, and subtracts the offset (in this case three words) from the stack pointer. With this technique,

local variables are referenced with negative offsets off "A0" and parameters are referenced with positive offsets. This technique of using the stack supports re-entrant code and recursion with no problems. Before dojunk exits, it uses UNLK to clear off the local variable space it used.

AIM + POWER
from **COMPUTECH**

All prices **postpaid** (Continental U.S.- otherwise \$2 credit)



Check the **outstanding documentation** supplied with AIM65!

Top quality power supply designed to Rockwell's specs for fully populated AIM65 — includes overvoltage protection, transient suppression, metal case and power cable:

- PSSBC-A (5V 2A Reg; 24V .5A Avg, 2.5A Peak, Unreg) **\$64.95**
- Same but an extra AMP at 5 volts to drive your extra boards: PSSBC-3 (5V 3A Reg; 24V .5A Avg, 2.5A Peak, Unreg) **\$74.95**

The professional's choice in microcomputers:

- AIM65/1K RAM **\$429.95** BASIC (2 ROMS) **\$59.95**
- AIM65/4K RAM **\$464.95** ASSEMBLER (1 ROM) **\$32.95**
- FORTH (2 ROMS) **\$59.95**

SAVE EVEN MORE ON COMBINATIONS

- AIM65/1K+PSSBC-A ... **\$479.95** AIM65/4K+PSSBC-3 ... **\$524.95**

We gladly quote on all AIM65/40 and RM65 items as well.

ORDERS: (714) 369-1084

P.O. Box 20054 • Riverside, CA 92516
California residents add 6% sales tax



SeaFORTH for the Apple computer

Is a consistent structured operating system providing the advanced programmer with the tool to easily develop programs from machine language to high level compiled applications. With SeaFORTH, the edit-compile-execute-edit cycle is measured in seconds, not minutes.

The integrated SeaFORTH package includes:

- Editor
- Disc I/O
- Assembler
- Hi-res Graphics
- Transcendental Floating Point
- Command Line Input with Editing
- Detailed 150 Page Technical Manual with Complete Source Listing!

Implemented as a true incremental compiler, SeaFORTH generates machine code, not interpreted address lists. SeaFORTH's direct-threaded-subroutine implementation executes faster than interpreted address-list versions.

Apple SeaFORTH requires a 48K Apple][+, with DOS 3.3. Manual and copyable disk are available for only \$100.00

Compatible SeaFORTH for the AIM requires a terminal and is only available in EPROMs. Manual and EPROMs \$150.00

Manuals available, separately, for only \$30.00
All prices include UPS shipping.
VISA or MASTER CHARGE welcome.
(Dealer Inquiries Welcome)

TAU LAMBDA
P.O. Box 808, Poulsbo, Washington 98370
(206) 598-4863

Apple][+ and AIM are registered trademarks of Apple Computer and Rockwell

Range Checking Using the MC68000

The MC68000 "CHK" instruction provides an efficient mechanism to insure that array bounds are not exceeded in high-level language implementations. As an example of range checking with CHK, consider the problem of enforcing array boundary checking in a simple Pascal program. Figure 5 shows the stack usage for a simple variable declaration using the same scheme described in the "Procedure Call" example. The individual elements of the array "data" will be accessed by indexing off the pointer "A0". The range checking's duty is to insure that we do not attempt to access an element of "data" before its true beginning or after element "MAX". The consequences of exceeding the array bounds range from inadvertently modifying another variable (such as "i", "j", or "misc") to stepping on a subroutine return link! Figure 6 shows a simple Pascal statement to clear the "ith" element of "data" and the MC68000 code to accomplish it with the necessary range check. The code assumes that register "D0" contains the current state of "i". The CHK instruction examines the lower word in the specified register ("D0") and generates an error trap if it is less than 0 or greater than "MAX". Otherwise, the code falls through to the MOVE instruction that clears the "ith" element of "data".

Conclusion

We hope this article has given you some insight into the extensive power of the MC68000. The 16-bit data bus, the 16 megabytes of directly addressable memory, the sixteen 32-bit user-accessible registers, the powerful instruction set, numerous addressing modes, and fast execution speed are enough to really get folks excited.

Future Growth

The MC68000 is not the only member of this powerful microprocessor family. Motorola is taking advantage of its modular, microprogrammed structure to develop other processors which are upward and downward compatible to the MC68000.

The MC68008 is a machine and assembly level-compatible version of the MC68000 with an 8-bit data and 20-bit address bus for low-cost systems that need the performance of the MC68000 and can tolerate a slight decrease in throughput for reduced system costs.

With the MC68010, Motorola adds virtual machine capabilities to the

Figure 5: Array Storage on the Stack for the Range Checking Example

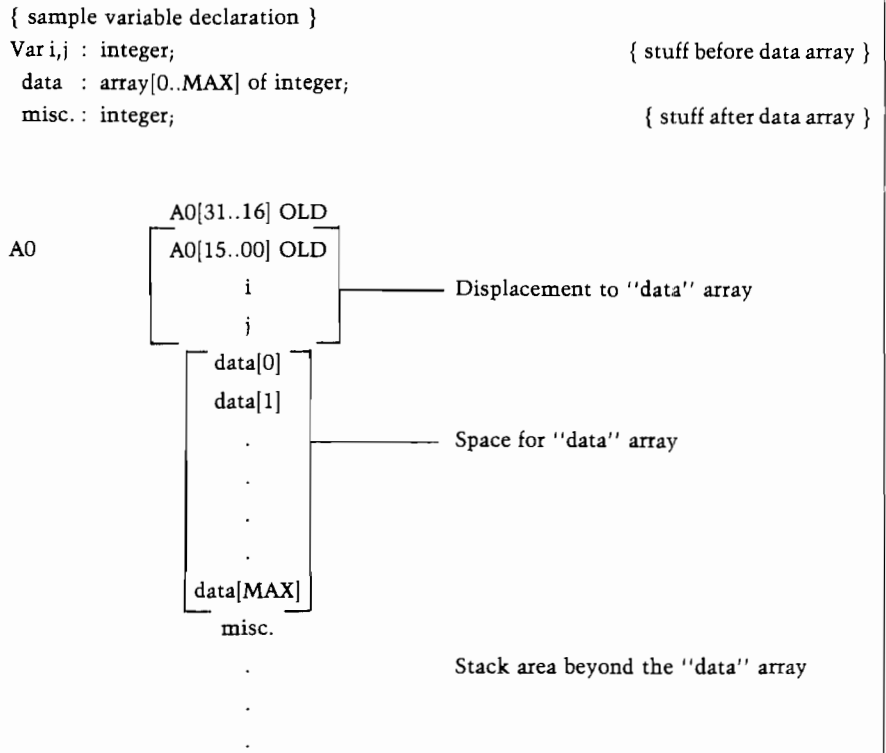

Figure 6: Example of Range Checking Using the MC68000

```

{ Pascal statement to clear the "ith" element of "data" }
data[i] := 0; { note: i < 0 or i > MAX is a range error!!! }

*
* MC68000 CODE TO EXECUTE THE ABOVE STATEMENT
*
*
* ASSUME D0 CONTAINS THE CURRENT CONTENTS OF "i"
*
* GENERATE A TRAP IF "i" < 0 OR IF "i" > MAX
*
*   CHK #MAX,D0
*
*   HERE IF NO RANGE ERROR OCCURRED
*
*   MOVE.W #0,DISP[A0,D0] CLEAR THE "ITH" ELEMENT OF DATA
*
*
*

```

MC68000 architecture.

A full 32-bit implementation (32-bit address and data buses) of the architecture with an enhanced instruction set and on-board cache is in design. The part will be designated the MC68020 and will contain all of the additional features of the MC68010.

A full complement of peripherals for the MC68000 family have been introduced or are in development. These include a Direct Memory Access controller (MC68440), a Memory Management Unit (MC68451), a Floating Point Arithmetic Co-processor (MC68881),

and several data communication parts.

Because of this commitment to the continuation and enhancement of the MC68000 family, systems and software for the MC68000 are insured a long useful life.

References

1. "16-Bit Microprocessor User's Manual," Motorola Inc., 1982.
2. "Motorola Resident Structured Assembler Manual," Motorola Inc., 1982.

MICRO™

FOUR TO GROW

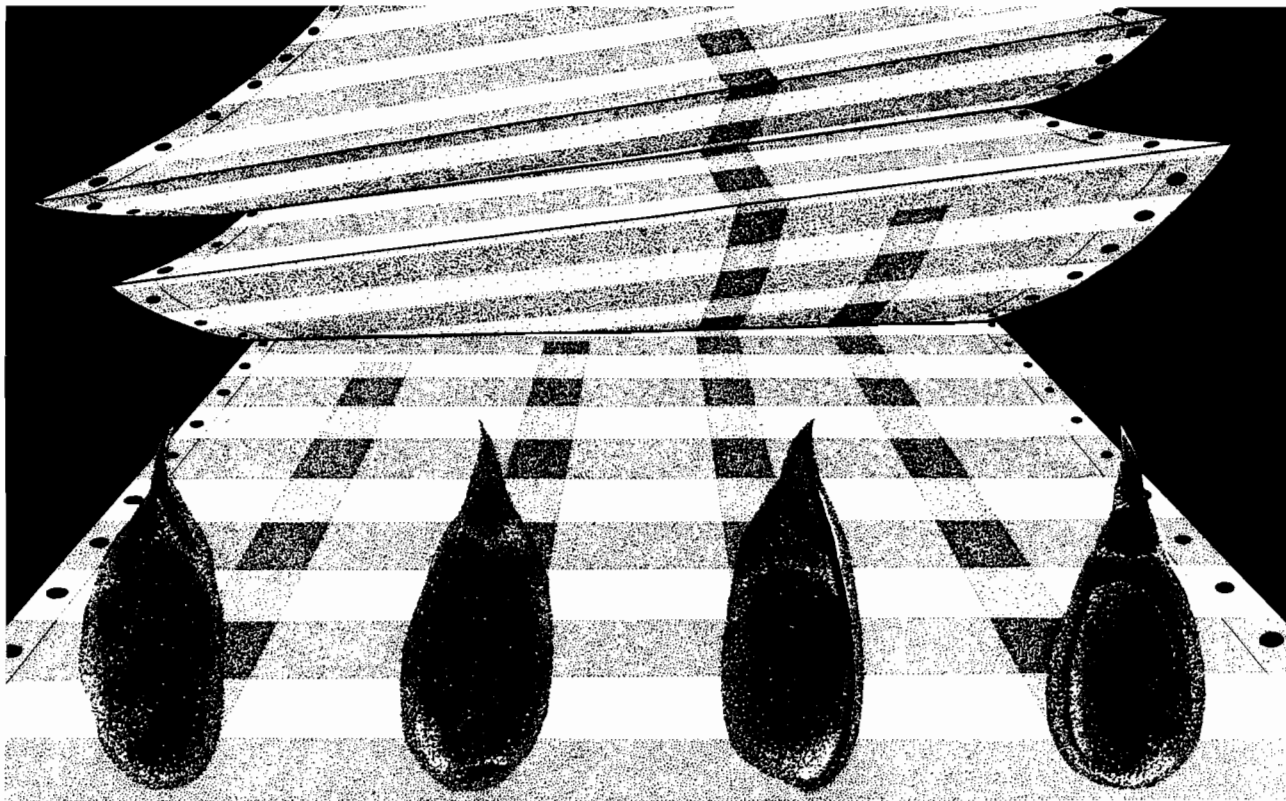

Four software packages, that is, to make your Apple® computer really grow! Versatility is the key to computing success, and with Advanced Operating Systems, it's as easy as one, two, three.

APPLE-AIDS is a collection of 12 Applesoft and machine language programs designed to bring you greater flexibility and control over your microcomputer.

In addition to several programs which allow you to examine and change various track/sector contents, format new disks, and create and edit EXEC files, APPLE-AIDS includes two programs you can't afford to be without. UNDELETE FILES allows you to recover accidentally deleted files which you thought were lost forever. KILL DOS removes DOS from any disk freeing up more space for your programs or data.

Russ Adams, a reviewer for INFO-WORLD, writes, "Its (APPLE-AIDS) documentation is the finest I have seen since joining the INFOWORLD Software Review Board." Ease of use and extensive documentation make APPLE-AIDS a valuable addition to every Apple software library. #26066, \$49.95

HELLO CENTRAL! changes your Apple II® or Apple II Plus® into a highly versatile communications center.

Establish direct communications with other computers of any make or tap into the wealth of information available from the hundreds of public-base services like THE SOURCE.

HELLO CENTRAL!'s most unique feature is its text buffer. Messages or entire files can be uploaded and downloaded into the text buffer which holds up to 18,000 characters. The buffer text can be scanned, changed, and then saved to disk.

The best thing about HELLO CENTRAL! is that you don't have to be a professional to get professional results. A few simple keystrokes will accomplish any of your text/communications tasks. #26081, \$99.00

MUSIC GAMES skillfully combines the sound and high resolution graphics of the popular Apple computer to provide both visual and audible reinforcement to the study of music. Twelve different programs, selected from a menu, cover ear training, note recognition and writing, rhythm practice, and listening enjoyment. These versatile games are written for ages 5 through adults. #26116, \$39.95

PEN PAL gives you the power and versatility of higher-priced word processors in an easy-to-use format. With only 29 commands, you can quickly and easily create lengthy reports or short memos. PEN PAL gives you 40- and 80- column screening, joystick control of the cursor for quick editing, complete printer control, plus both upper and lower case capabilities. PEN PAL is the affordable solution to your word processing needs. #25115, \$59.95

Advanced Operating Systems has four good ways to make you and your Apple grow and grow!

Now available at your local software retailer, or call 1-800-428-3696 to order. (Indiana residents, call (317) 298-5566.) MasterCard and VISA accepted.

ADVANCED OPERATING SYSTEMS

4300 West 62nd Street
P.O. Box 7092
Indianapolis, IN 46206

A Division of
Howard W. Sams & Co., Inc.

Apple, Apple II and Apple II Plus are registered trademarks of Apple Computers, Inc.

AARDVARK — THE ADVENTURE PLACE

ADVENTURES FOR OSI, TRS-80, TRS-80 COLOR, SINCLAIR, PET, VIC-20

ADVENTURES — Adventures are a unique form of computer game. They let you spend 30 to 70 hours exploring and conquering a world you have never seen before. There is little or no luck in Adventuring. The rewards are for creative thinking, courage, and wise gambling — not fast reflexes.

In Adventuring, the computer speaks and listens to plain English. No prior knowledge of computers, special controls, or games is required so everyone enjoys them—even people who do not like computers.

Except for Quest, itself unique among Adventure games, Adventures are non-graphic. Adventures are more like a novel than a comic book or arcade game. It is like reading a particular exciting book where you are the main character.

All of the Adventures in this ad are in Basic. They are full featured, fully plotted adventures that will take a minimum of thirty hours (in several sittings) to play.

Adventuring requires 16k on Sinclair, TRS-80, and TRS-80 Color. They require 8k on OSI and 13k on VIC-20. Sinclair requires extended BASIC.

TREK ADVENTURE by Bob Retelle — This one takes place aboard a familiar starship and is a must for trekkies. The problem is a familiar one — The ship is in a "decaying orbit" (the Captain never could learn to park!) and the engines are out (You would think that in all those years, they would have learned to build some that didn't die once a week). Your options are to start the engine, save the ship, get off the ship, or die. Good Luck.

Authors note to players — I wrote this one with a concordance in hand. It is very accurate — and a lot of fun. It was nice to wander around the ship instead of watching it on T.V.

CIRCLE WORLD by Bob Anderson — The Alien culture has built a huge world in the shape of a ring circling their sun. They left behind some strange creatures and a lot of advanced technology. Unfortunately, the world is headed for destruction and it is your job to save it before it plunges into the sun!

Editors note to players — In keeping with the large scale of Circle World, the author wrote a very large adventure. It has a lot of rooms and a lot of objects in them. It is a very convoluted, very complex adventure. One of our largest. Not available on OSI.

HAUNTED HOUSE by Bob Anderson — This one is for the kids. The house has ghosts, goblins, vampires and treasures — and problems designed for the 8 to 13 year old. This is a real adventure and does require some thinking and problem solving — but only for kids.

Authors note to players — This one was fun to write. The vocabulary and characters were designed for younger players and lots of things happen when they give the computer commands. This one teaches logical thought, mapping skills, and creativity while keeping their interest.

DERELICT by Rodger Olsen and Bob Anderson — For Wealth and Glory, you have to ransom a thousand year old space ship. You'll have to learn to speak their language and operate the machinery they left behind. The hardest problem of all is to live through it.

Authors note to players — This adventure is the new winner in the "Toughest Adventure at Aardvark Sweepstakes". Our most difficult problem in writing the adventure was to keep it logical and realistic. There are no irrational traps and sudden senseless deaths in Derelict. This ship was designed to be perfectly safe for its' builders. It just happens to be deadly to alien invaders like you.

PYRAMID by Rodger Olsen — This is one of our toughest Adventures. Average time through the Pyramid is 50 to 70 hours. The old boys who built this Pyramid did not mean for it to be ransacked by people like you.

Authors note to players — This is a very entertaining and very tough adventure. I left clues everywhere but came up with some ingenious problems. This one has captivated people so much that I get calls daily from as far away as New Zealand and France from bleary eyed people who are stuck in the Pyramid and desperate for more clues.

QUEST by Bob Retelle and Rodger Olsen — THIS IS DIFFERENT FROM ALL THE OTHER GAMES OF ADVENTURE!!!! It is played on a computer generated map of Alesia. You lead a small band of adventurers on a mission to conquer the Citadel of Moorlock. You have to build an army and then arm and feed them by combat, bargaining, exploration of ruins and temples, and outright banditry. The game takes 2 to 5 hours to play and is different each time. The TRS-80 Color version has nice visual effects and sound. Not available on OSI. This is the most popular game we have ever published.

MARS by Rodger Olsen — Your ship crashed on the Red Planet and you have to get home. You will have to explore a Martian city, repair your ship and deal with possibly hostile aliens to get home again.

Authors note to players — This is highly recommended as a first adventure. It is in no way simple—playing time normally runs from 30 to 50 hours — but it is constructed in a more "open" manner to let you try out adventuring and get used to the game before you hit the really tough problems.



NUCLEAR SUB by Bob Retelle — You start at the bottom of the ocean in a wrecked Nuclear Sub. There is literally no way to go but up. Save the ship, raise her, or get out of her before she blows or start WWII.

Editors note to players — This was actually plotted by Rodger Olsen, Bob Retelle, and someone you don't know — Three of the nastiest minds in adventure writing. It is devious, wicked, and kills you often. The TRS-80 Color version has nice sound and special effects.

EARTHQUAKE by Bob Anderson and Rodger Olsen — A second kids adventure. You are trapped in a shopping center during an earthquake. There is a way out, but you need help. To save yourself, you have to be a hero and save others first.

Authors note to players — This one feels good. Not only is it designed for the younger set (see note on Haunted House), but it also plays nicely. Instead of killing, you have to save lives to win this one. The player must help others first if he/she is to survive — I like that.



ADVENTURE WRITING/DEATHSHIP by Rodger Olsen — This is a data sheet showing how we do it. It is about 14 pages of detailed instructions how to write your own adventures. It contains the entire text of Deathship. Data sheet - \$3.95. NOTE: Owners of OSI, TRS-80, TRS-80 Color, and Vic 20 computers can also get Deathship on tape for an additional \$5.00.

PRICE AND AVAILABILITY:

All adventures are \$14.95 on tape except Earthquake and Haunted House which are \$9.95. Disk versions are available on OSI and TRS-80 Color for \$2.00 additional.

Please specify system on all orders

ALSO FROM AARDVARK — This is only a partial list of what we carry. We have a lot of other games (particularly for the TRS-80 Color and OSI), business programs, blank tapes and disks and hardware. Send \$1.00 for our complete catalog.

AARDVARK - 80

2352 S. Commerce, Walled Lake, MI 48088

(313) 669-3110

Phone Orders Accepted 8:00 a.m. to 4:00 p.m. EST. Mon.-Fri.



TRS-80 COLOR

SINCLAIR

OSI

VIC-20

A Monitor for the Color Computer

by Ralph Tenny

This article provides step-by-step instructions to get composite video from the video section of the Color Computer. You will use this signal to drive a standard video monitor instead of a color or black-and-white TV set.

Required:

- TRS-80 Color Computer
- A monitor-quality CRT

The Radio Shack Color Computer, an excellent low-cost computer, uses a color TV set as the intended display device. Unfortunately, TV sets have relatively low resolution, which limits the clarity of the display. The use of a TV set can be either good or bad, depending on whether color graphics are used in your program. Since I use it as a text processing system, I need a video terminal with maximum display clarity. Even the relatively low character density of the Color Computer's video output isn't very clear on the average TV set — either color or B&W. The signal itself is of high technical quality, and a higher-resolution display can make a great improvement in the readability of the display. If a B&W monitor is substituted for the TV set, this goal is achieved. As you can see from photo 1, my video monitor (which is not a super-high resolution unit) gives an excellent display capability when used with the Color Computer.

Since the remainder of the article describes a process of modifying the Color Computer, you should realize that any internal modifications will probably void the warranty. If the computer is more than three months old, the warranty will have expired. If you modify the computer and it needs repair, you may have to remove the modification before Radio Shack will repair it. I have not had any problems in

over a year, and I still feel comfortable with my decision.

The Color Computer's video output is a complete TV signal and is generated by a very low-power TV transmitter mounted within the Color Computer. Part of the display problem is the fact that the TV tuner is deliberately

limited, therefore the signal must also be limited. Even if the tuner is bypassed, the TV's display resolution is reduced as a cost-saving measure, since high resolution is not required for normal TV viewing.

The Color Computer uses an MC6847 Video Display Generator to produce all the signals required to drive a TV set; these include composite sync, blanking, video luminance, and color information. The basic approach is to use a buffer amplifier to process the output of the MC6847, enabling the signal to be fed directly to a video monitor. Figure 1 shows the schematic of this buffer amplifier; it was patterned after circuitry suggested by Motorola, the manufacturer of the 6847. This amplifier was built on thin, two-sided, copper-clad board with one side etched into small pads. Figure 2 is a full-size layout of the amplifier board, and figure 3 shows the parts layout.

Access to the Color Computer is easy and requires only that you take out seven screws to remove the top. Note that one screw is located beneath a factory seal. If you remove this screw

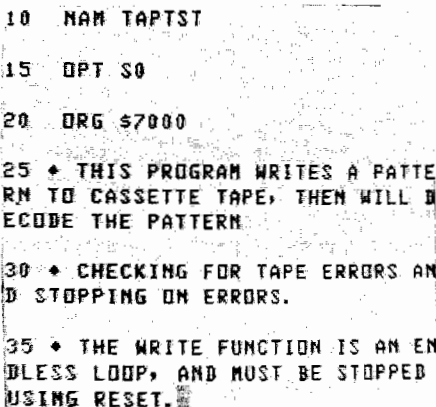

Photo 1: A close-up look at a Color Computer display on a video monitor. Note that each pixel is a sharply-defined square.

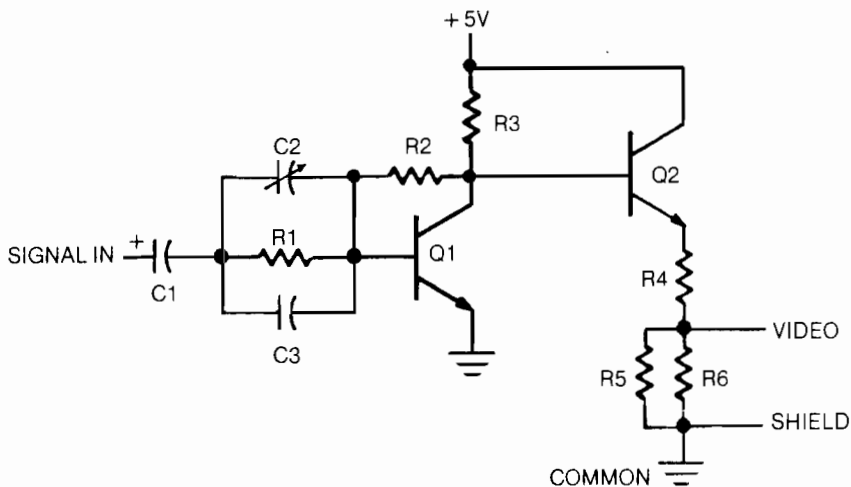

Figure 1: Schematic for the video buffer amplifier, which mounts internal to the computer. It amplifies the video output of the 6847 and turns it into a low-impedance signal suitable for driving a cable to the external monitor.

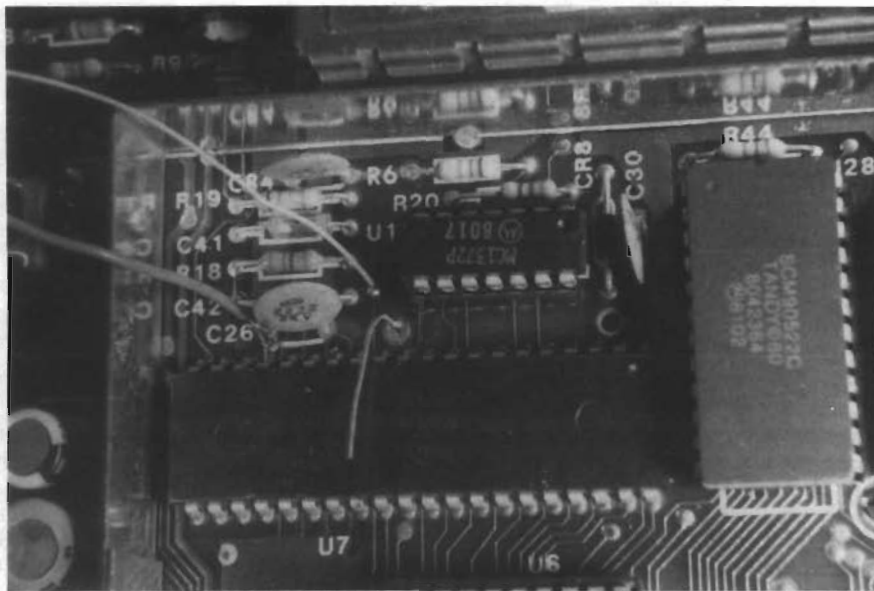

Photo 2: Interior view of the area where the amplifier will be mounted. The long IC is the MC6847, which will be covered by the buffer amplifier as shown in photo 3.

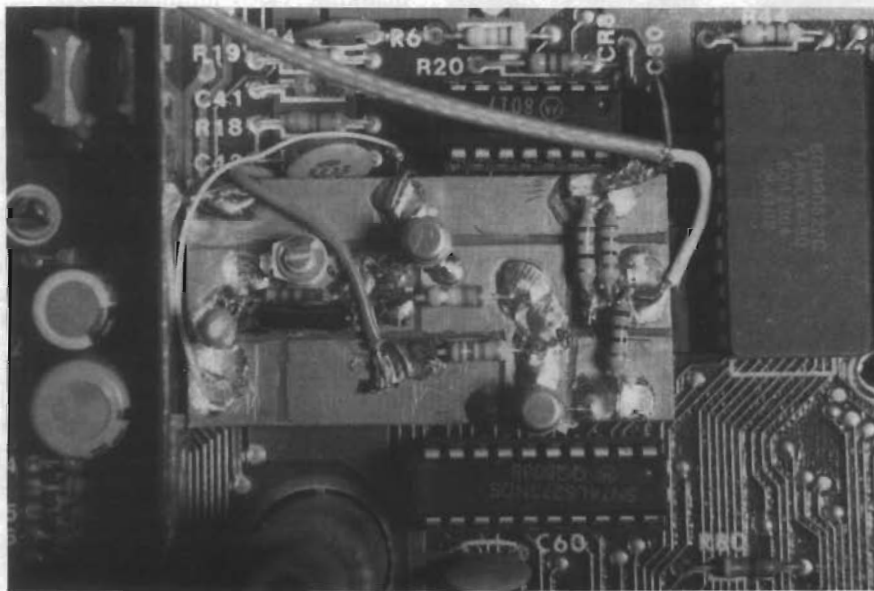

Photo 3: A view of the buffer amplifier mounted, with the output cable attached.



Figure 2: Full-size layout of the amplifier board. Make the board by etching the lines shown to divide the board into eight segments as shown.

you will deface the seal, which voids your warranty.

Once you loosen the screws, put a piece of tape over each hole so the screws will not fall out when you turn the computer upright. With the screws loosened, the top will lift off, leaving the keyboard resting on standoffs and revealing the inner RF shield.

Note that the top of the shield is a friction fit to the shield sides via numerous spring-loaded fingers. Work the shield top off by lifting it a little bit all around; keep lifting until it lifts straight off. Once you can see inside, find the MC6847 and MC1372 ICs as shown in photo 2. Also, in photo 2, you will note a solid ground wire curving up over the 6847, plus a heavy wire coming from one side of C26 and smaller wire coming off the circuit board between C42 and the 1372. The solid wire is circuit common, the large wire is +5 volts, and the small wire is the signal input to the buffer board. Photo 3 shows the video buffer installed, resting on the 6847. The large wire has been soldered to the +5 volt input of the buffer board, the ground wire to the amplifier common, and the small wire to the amplifier input. A small 183-ohm cable has its shield soldered to the amplifier common and the center conductor to the amplifier output. The other end of the 183-ohm cable runs across to the corner of the RF shield (the top left corner of the shield as seen from the front of the computer).



Photo 4: Oscilloscope trace of the output video showing one video frame.

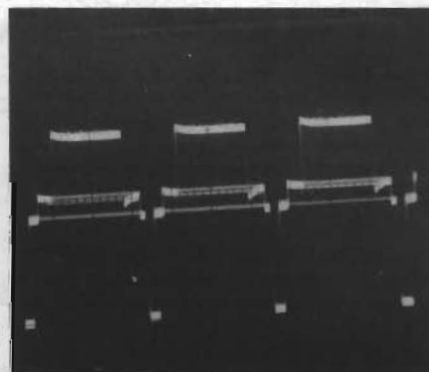

Photo 5: An oscilloscope trace of three lines of horizontal video.

Parts List for Video Buffer Amplifier Circuit

C3	68 pF dipped mylar capacitor
R1	33K ohm, 1/4-watt resistor
R2	62K ohm, 1/4-watt carbon resistor
R3	5.1K ohm, 1/4-watt carbon resistor
R4, R5, R6	51 ohm, 1/4-watt carbon resistor
Q1, Q2	2N2222 NPN transistors

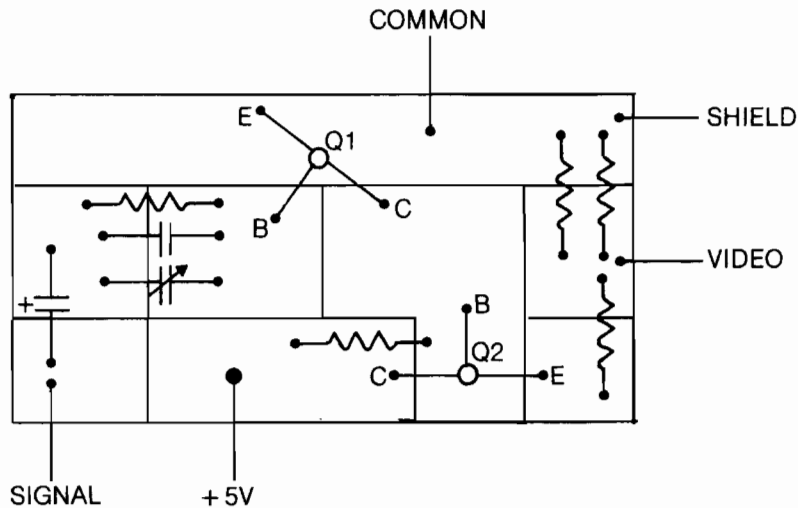

Figure 3: Parts layout for the amplifier board. Each part is soldered into place in the approximate location sketched.

Once the amplifier is in place, turn on the computer and check the video output from the cable. Photo 4 shows one vertical frame of video, and photo 5 shows three horizontal lines of video. If your amplifier does not have similar output, double-check the circuit and adjust C2 until the response is correct.

After testing the amplifier, send its output into a video monitor and make whatever level adjustments are needed

to obtain a good picture. Once the monitor is working, re-install the computer cover and enjoy your computer's new display.

You may contact the author at P.O. Box 545, Richardson, Texas 75080.

MICRO

OHIO SCIENTIFIC

THE WIZARD'S CITY — search for gold in the dungeons beneath the Wizard's city or in the surrounding forest. A dynamic adventure allowing progress in strength and experience. All OSI — cassette \$12.95, disk \$15.95.

OSI HARDWARE 15% OFF RETAIL PRICES!

GALACTIC EMPIRE — a strategy game of interstellar conquest and negotiation. Compete to discover, conquer, and rule an empire with the computer or 1-2 other players. C4P, C8P cassette \$12.95, disk \$15.95.

AIR TRAFFIC ADVENTURE — a real time air traffic simulation. C4P, C8P disks \$15.95. Plus S-FORTH, PACKMAN, CRAZY BOMBER, ADVENTURE, TOUCH TYPING, INTELLIGENT TERMINAL and more. Send for our free catalog including photos and complete descriptions.

(312) 259-3150

Aurora Software Associates
37 S. Mitchell
Arlington Heights
Illinois 60005

OLYMPIC SALES CO

Telex: 67 34 77 Toll-Free Phone Orders:
Toll-free (in CA) 800-252-2153 800-421-8045 (out of CA)
Order Desks open 6 days a week! 7:00 AM to 6:00 PM Mon-Sat
P.O. Box 74545 216 So. Oxford Ave. Los Angeles, CA 90004
Phone: (213) 739-1130 Cable: "OLYRAV" LSA

We carry close to \$5,000,000 inventory at all times. Corp. accs. invited. Good subject to availability; this ad supersedes all previous ads; for our warehouse, prices subject to change without notice; not responsible for typographical errors; all orders subject to verification; minimum ship & handle \$5.95. Send \$2 for \$5 foreign for our famous catalog.

BMC 12" Green Monitor
Model BM-12A
\$99.95

Texas Instruments TI-5010 Handheld Calculator Plain paper printer
\$39.95

Texas Instruments TI-99/4A Home Computer
Now Only **\$199.95** AFTER MFG'S REBATE — you pay OSC \$299.95, TI rebates you \$100. Plus FREE \$50 RF Modulator with purchase of TI-99/4A

HEWLETT PACKARD LCD
HP-16C Computer Scientist — for Programmers & Digital Designers 127.50 WE ARE AUTHORIZED FULL LINE HP Dealers.

TP-1 TEXT PRINTER
RE: \$995.00 Daisy wheel printer
\$669.95

KEYPHONE™
Range of 700 feet Trimming styling Last number redial Instant on/off Automatic security lock Built-in charger
Model 6100D with automatic dialing 10 memories Y/C: \$119.95
\$99.95

HP-10C
Up to 79 lines of program storage
RE: \$80.00
\$80.00
Your Cost: **\$69.95**

VICTOR YOUR COST: \$395.00
VICTOR 5080 80 Column Printer
A real work horse! 100 cps, graphics, buffer, 4 interfaces including HP-IB
Retail: \$995.00 Wholesale: \$670.00 Fully guaranteed by Victor, in business since 1918

olivetti Your Cost \$429.95
"PRAXIS 35"
ELECTRONIC TYPEWRITER Interchangeable 'Daisy Wheel' type element, 3 sizes-Pica, Elite & Micro plus cartridge ribbon & more!
Retail: \$750.00

LEX-21 Portable Terminal
8 1/2" X 11" X 2 1/4" LEXICON
\$995

10" color monitor high res	339.95
32K memory module	314.95
Extended Basic	75.00
Speech synthesizer	129.95
Disk memory drive	394.95
Telephone coupler (modem)	189.95
Printer (solid state)	319.95
TI-LOGO	99.95

ATARI® COMPUTERS

ATARI 800-16K	647.95
ATARI 800-48K (Axlon 32K chip)	779.95
Atari 810 Disk Drive	459.95
Atari Interface Module	177.95
Atari Educator Kit	117.95

ATARI 400-16K \$199.95*
* You pay OSC \$259.95 & receive a coupon worth up to \$60 in rebates from Atari on the purchase of add'l software or accessories for the Atari 400.

SHARP HAND-HELD COMPUTERS

PC 1500 Pocket Computer	213.95
CE 150 Color graphic printer w/cass. interface	173.95
4K Expansion module	53.95
8K Expansion module	103.95

TI EXPANSION BOX SYSTEM

PHP 1200 Expansion Box	209.95
PHP 1220 RS232	136.00
PHP 1240 Disk Controller	194.00
PHP 1250 Disk Drive	299.00
PHP 1260 32K Mem. expansion	234.00
PHP 1270 Pascal Card	194.00

Programmable TI-59
Your Cost: \$169.95 plus — \$20.00 rebate from TI plus Free Library
TI LCD Programmer 59.95
WE ARE AUTHORIZED FULL LINE TI DEALERS

OKIDATA PRINTERS

82A Bi-directional	444.95
83A Bi-dir/serial/parallel	684.95
84 Parallel, 200 CPS	1144.95
84 Serial, 200 CPS	1274.95

EXTEND-A-PHONE
EX-4000 Cordless Speaker Phone
Re: \$229.95 Y/C: \$163.95

Commodore VIC-20
FREE RF Modulator
with purchase of VIC-20 Works with any TV!
5K Personal Computer (Expands to 32K)
We are authorized FULL-LINE Commodore dealers.

Commodore VIC-20
Your Cost: **\$197.95**
Retail: \$300.00

Model 1540 Single 5 1/4" Drive	334.95
Model 1515 Graphics Printer	329.95
Model 1530 Datasette Recorder	59.95

SANYO MONITORS
High resolution, number one seller!

	Retail	Your Cost
VM4509 9" B & W	190.00	159.95
VM4215 15" B & W (below our cost)	349.00	189.95
DM5109 9" Green	200.00	169.95
DM8012 12" B & W	250.00	199.95
DM8112 12" Green	260.00	209.95
DMC6013 13" Color, hi quality	470.00	399.95
DMC6113 13" Color RGB hi res (NEW) 12" B & W	395.00	329.95
DM2012 (NEW) 12" B & W	179.00	139.95
DM2112 (NEW) 12" Green	199.00	159.95

APPLE COMPUTER

48K Plus	1069.95
Disk dr w/controller	494.95
Disk dr - no controller	419.95
Apple 2 System package	1695.00

FOR COMPLETE GRAPHICS: VersaWriter

EDUCATION

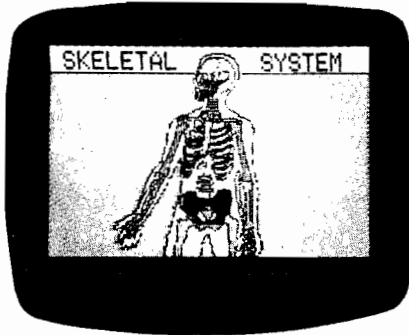

ARTIST



GAME PROGRAMMER

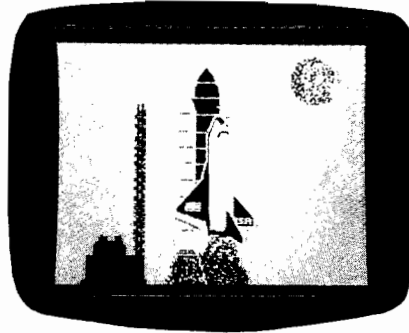

HOBBIST

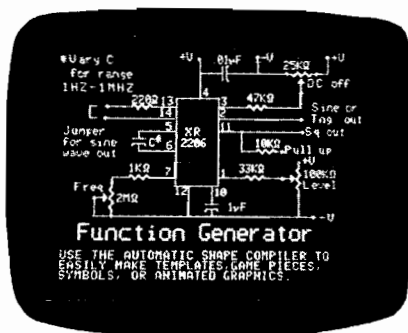

ENGINEERING

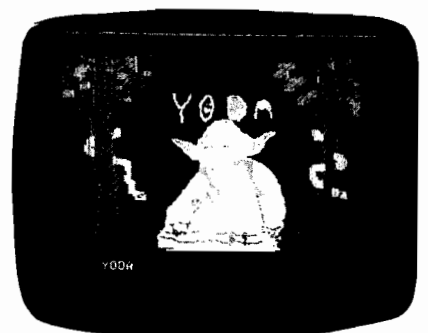

CHILDREN

Whether you are a teacher, an artist, an engineer, a programmer, or a hobbyist with little or no programming experience, the VersaWriter is the answer to your graphics need. With the VersaWriter exploring the world of micro computer graphics is as easy as tracing. The VersaWriter

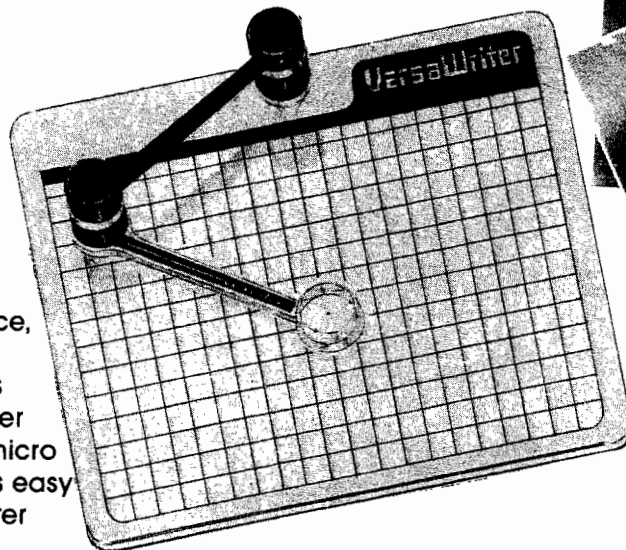

doesn't just trace a picture though. With simple one key commands you can add color and text to your pictures, move objects across the screen, make scale drawings and even draw with different size brushes. The VersaWriter is as limitless as your imagination.

For complete graphics on your Apple II/II+, or IBM PC, the Versa Writer from Versa Computing, Inc. is your answer. Complete hardware/software system ready for use - \$299.

Send for information on the complete line of VERSAWRITE & Graphics Products

Dealer Inquiries Welcome

VERSA
COMPUTING, INC.

3541 Old Conejo Road, Suite 104 • Newbury Park, CA 91320 • (805) 498-1956

FLEX and the TRS-80 Color Computer

by Ronald W. Anderson

Here is a brief description of the FLEX09 operating system as implemented on the TRS-80 Color Computer.

The configuration described here is available from Frank Hogg Laboratories (130 Midtown Plaza, Syracuse, NY 13210) with 64K or RAM installed (\$1275), as well as an assortment of disk drive packages. If you already have a TRS-80, then Frank Hogg Laboratories sells the operating system and modification instructions separately (\$99). While it is possible to run the FLEX operating system with one disk drive, two are recommended. You may choose from a minimum package of one single-sided, double-density, 35-track drive, or up to three double-sided, double-density, 40-track drives. The latter will hold up to 375K of data on each drive. You may also use one of the 80-track, double-density drives and have over 700K bytes on one disk, although the 80-track version is not compatible with Radio Shack's disk operating system.

FLEX is the standard operating system for 6800 and 6809 systems. FLEX is so universal that there are versions that will run on the Motorola Exorciser. FLEX is a "Unix-like" operating system and has a nice set of calls that do all the work to interface your assembler program to the disk drivers. There are literally 100 utility programs available for FLEX.

The manual that comes with the operating system is basically the FLEX operating system manual with additional pages that apply to the Color Computer. There is a well-written section on getting your system up and running. First you configure the software to match your hardware. The system boots up expecting 35-track, single-sided drives. To access more tracks or double-sided drives, you must run a utility program that will tell the

system you have 40 tracks and double-sided drives, for example. Your drives need not all be alike. You may specify drive 0 as being single-sided and having 35 tracks, and drive 1 as being double-sided and having 40 tracks. Although this might seem like a nuisance, you only need to run the utility program once. This generates a command file that is appended to FLEX containing information on your drives, the terminal, and drivers for your printer.

I did a bit of experimenting with the SETUP command that does all the configuring, and discovered I could specify "reverse video," which is really "normal video" to anyone who has worked in front of a terminal for any time. I find a blinking cursor to be distracting, so I made it a plain block cursor. Now my system will power up just the way I want it.

Another feature is the keyboard's ability to provide all the ASCII codes. The control codes, such as Control C, are generated by holding the shift and up arrow simultaneously (equivalent of the control key on a terminal), and then pressing the desired key, C for example. If you ever program in Pascal and/or "C", you will need several characters that are not included on the Color Computer keyboard.

Without going into detail, I will give an example of the key assignments and how to access them. You may remember that upper case (SHIFT) 8 is a left parenthesis "{", and SHIFT 9 is a right parenthesis "}". Use the CONTROL combination (SHIFT ^) and type 8 and you get a left square bracket "[". SHIFT ^ 9 and you get a right square bracket "]". "C" requires the use of curly braces. SHIFT ^ BREAK 8 will cause a left brace "{" to be generated, and the same combination for a 9 will generate a right curly brace "}". The control and shift keys are depressed first, and are all held simultaneously before keying the 8 or

9. Holding three keys down and typing a fourth is not easy, but it's better than not being able to generate the code for those characters.

Sometimes disk drives run slightly fast, or irregularly, and squeezing the sectors close enough to get 18 on a track results in unreliable disk access. There is a NEWDISK utility that will automatically reduce the number of sectors to 17 if it encounters problems. Another NEWDISKA utility will put 18 sectors on closer together. I have had no trouble using NEWDISKA. A sector in the FLEX system is 256 bytes long, but four bytes are used for system purposes, so a sector actually holds 252 bytes of data. A single-sided, 35-track disk will hold 612 sectors (using NEWDISKA). If your drive has 40-track capability, you will get 702. A double-sided 40-track will result in 1404. If these numbers don't seem to add up correctly, it is because FLEX uses the first track (track 0) for a loader, disk system information record, and file directory sectors. Also, FLEX requires that track 0 always be single density. Therefore, the tracks actually available to the user are one less than the total number on the disk.

Once FLEX is running, make another copy of the system disk. Use NEWDISK or NEWDISKA to format a blank disk, and then use a utility called PUTBOOT.LDR to install the loader on the disk. The loader is readable by the Color Computer disk operating system. It loads a short program that loads and executes a longer loader program that loads all of the FLEX operating system. It sounds complicated but only takes a few seconds to execute. You *must* put the boot loader on your disk first. If you have copied any files onto the newly formatted disk, there is a chance that the system may have allocated you space where the boot loader needs to be. PUTBOOT will inform you that you can only in-

PROFESSIONAL WORD PROCESSOR

- Double Columns
- Right Justification
- Printer Graphics
- Variable Line Space
- Printer Control Code
- Page by Paragraph
- Line Centering
- Shorthand
- Margin Control
- Form Letters

FOR APPLE/PET/CBM

COPY-WRITER by IDPC Co.
only \$185.00

EXCHANGE DATA w IBM 3740

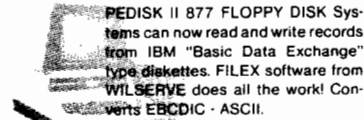

EXCHANGE System (877/FILEX) \$1295.
PEDISK 877-1 8" Floppy for PET \$ 995.
PEDISK 540-1 5" Floppy for PET \$ 595.
CONTROLLER BOARD w PDOS \$ 229.
 PEDISK II is a high performance floppy disk system designed for the Commodore PET/CBM, Rockwell AIM and Synertek SYM. It features high performance, simple reliable design and IBM format.

SOFTWARE FOR PEDISK II
COPYWRITER Pro Word Processor \$185.
MAE Macro Assembler Editor by EHS \$170.
FLEXFILE II Data Base Manager \$ 80.
PAPERMATE Word Processor \$ 60.
DISK UTILITY PACK \$ 25.
FASTFILE Data Base \$100.
FILEX IBM Access Routines \$245.
MENU LOAD \$ 10.
fullFORTH+ \$100.

Commodore Communicates! COMPACK \$129.

Intelligent Terminal Package including: ACIA based interface
 DB25 cable
 STCP software

- Remote Telemetry
- Transfer to/fr Disk
- Printer Output
- XON-XOFF Control
- User Program Cntl
- Status Line

\$139 COLOR CHART

AIM/SYM system video display, 64 x 16 characters, 8 colors, plugs into ROM socket, 4K RAM Multiple modes; semi graphics, alpha.

PET/CBM color graphic display, 128 x 192 pixels, generate color bar graphs on one screen with data on main screen. RS170 video color chart. 6847 based video output.

COLOR VIDEO FOR PET/CBM/AIM/SYM

ROMSWITCH - 4 ROMS IN 1 SPACEMAKER \$39.95

Switch 4 ROMs into the same socket. A slide switch activates one of four. Electronic controls insure no glitches and allow ROM switching under software control. ROMs can be switched from the keyboard.

fullFORTH+ for APPLE/PET

FULL FIG FORTH implementation plus conditional assembler, floating point, string handling, multi-dimensional arrays, and disk virtual mamory.

fullFORTH+ from IDPC Co. \$100
 Target Compiler. \$ 50

SEE YOUR DEALER OR:

MICROTECH

P.O. Box 102
 Langhorne, Pa. 19047
 215-757-0284

DEALER INQUIRIES INVITED

stall the loader on a newly formatted disk, and quit.

After installing the loader, you may copy everything from the system disk to your new system disk *except the loader installation utility PUTBOOT.LDR*. An attempt to copy it will get you a DISK SPACE FULL error and a lot of garbage on your disk. If you try to GET PUTBOOT.LDR (for those of you not familiar with FLEX, GET is a utility that reads a disk file to memory but doesn't execute it), you will find that it tries to execute, finds that you haven't specified a drive number, and erases itself from memory before returning to FLEX. Unless you enjoy "puzzles" and are quite familiar with FLEX and the format of binary files, you will have to use your master disk to make all further system disks.

Having copied all the supplied files to your system disk, you must run one further utility, called LINK. LINK will tell the boot loader just where on the disk the file FLEX.SYS is located. My advice is to make two system disks, and hide the master and one of them in a safe place where they won't get hot, bent, or damaged by a magnet. When you wipe out your working system disk you can get the backup and generate another backup for the safe storage area.

The video display looks like a terminal. Most terminals accept control codes to do such things as clear the screen, position the cursor for the next letter to be output, etc. A set of such codes has been provided. You can control the display without getting into the assembler-level CRT driver code. That will make it easier for software suppliers to write compatible software for the Color Computer.

The Color Computer format is 16 lines of 32 characters each, and the character generator displays lower case in reverse video, which is barely usable. Software will soon be available to allow use of any standard ASCII RS-232 terminal on the serial port of the Color Computer. I have a preliminary version of the software which will eliminate the display problem completely, but I imagine that many purchasers will want to use a TV set and the supplied keyboard for some time, before investing in a terminal. The enhanced display software will therefore be welcome.

A SDC (single disk copy) utility allows copying with a single drive. It reads files from the source disk until memory is full or it has read all the files to be copied, then it prompts you to insert the destination disk for a write cycle, etc., until the copy is complete. LINK and PUTBOOT.LDR both prompt you, and therefore give an opportunity to change disks so these operations may

be performed with a single disk drive also.

The HELP utility and file help you find or remember FLEX commands. If, for example, you type HELP,NEWDISK you will get a brief description of what the NEWDISK utility does, and a reference to a page in the manual.

If you have a serial printer, you will have no trouble configuring the system so you can use it effectively. A parallel printer will require a serial adaptor of some sort. Epson provides one for their printers, and Computerware of their-cinittas, CA, offers one for about \$60.

Of course you can run Radio Shack Extended Disk BASIC, which comes in the Color Computer in ROM. The RS disk operating system is well thought out. Both Random Access and Sequential files are implemented. Since the Color Computer comes up running the BASIC from ROM, you might wonder where the operating system is. Actually, it is part of BASIC. While running BASIC you may DIR a disk (prints the directory of a RS disk). You may copy or back up a disk, load and save programs (either BASIC or machine language), and still in BASIC, you may read or write any sector on the disk by specifying the track and sector number, and the ID of two string variables. The first 128 bytes of the sector is read to/written from the first named string variable, and the last 128 bytes to/from the second. That means you can write your own disk system and have fast access! Naturally, the RS BASIC has all the color graphics commands and sound commands, so you can write game programs and/or use graphics.

The Color Computer is a good buy for anyone wanting to get into this expensive hobby with a small investment. If you have the minimum system from RS, which is very inexpensive, you can first have RS upgrade your Color Computer to 32K, and then do the very simple modification to 64K. From that point, you are off into the world of FLEX, with at least five Pascal compilers, three or four BASIC interpreters, several versions of "C", Fortran, Cobol, a couple versions of FORTH, three editors, a good text processor, several assemblers, an excellent debugger program for assembler programs, and much more.

Mr. Anderson is vice president in charge of engineering for Industrial Computer Controls Corp. in Ann Arbor, MI. You may contact him at 3540 Sturbridge Ct., Ann Arbor, MI 48105.

MICRO



FOR YOUR APPLE II

Industry standard products at super saver discount prices



PARALLEL PRINTERS NEC 8023 or C-ITOH 8510

(Virtually identical) Specifications: • 100 CPS dot matrix printer • 80 column print—136 characters per line • Tractor/friction feed • 7 different print fonts included • 2K printer buffer • Proportional spacing • Bit image graphics and graphic symbols.

- NEC 8023 or C-ITOH \$495
- NEC 8023 or C-ITOH 8510 with Parallel Interface and Cable \$550
- EPSON 100 with Parallel Interface and Cable \$749

Z-80 CARD FOR YOUR APPLE MICROSOFT SOFTCARD

With CP/M* and MBASIC.
(List: \$399) **\$289**



Best Buy!!! ADVANCED LOGIC SYSTEM Z-CARD With C-PM*

Has everything the Softcard has except MBASIC. Works with Microsoft's disks too.
(List \$269) **Special at \$195**



ALS SYNERGIZER

CP/M* operating package with an 80 column video board, CP/M* interface, and 16K memory expansion for Apple II. Permits use of the full range of CP/M* software on Apple II. Includes SuperCALC.
(List: \$749) **\$549**



U-Z-80 PROCESSOR BOARD (From Europe)

Software compatible with Softcard and ALS Software **\$149**

MICROSOFT + PREMIUM SYSTEM

Includes Videx Videoterm, Softswitch, Microsoft and Softcard, Microsoft and Z-80 Card, and Osborn CP/M* Manual **\$595**

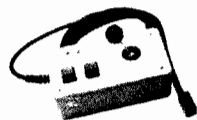

JOYSTICK

Takes the place of two Apple Paddle Controllers.

From BMP Enterprises. Heavy duty industrial construction and cable. Non-self centering. With polarity switches for consistent motion control.
(List: \$59) **\$39**

MONITORS FOR YOUR APPLE

- AMDEK 300G (18MHZ Anti-Glare Screen) \$179
- NEC 12" HIRES GREEN \$179
- SUPER SPECIAL!**
- SPECIAL 12" GREEN MONITOR **\$99**

SPECIAL AND NEW

5 MEGABYTE HARD DISK

For Apple II. Supplied with controller. Use with CP/M, Apple DOS, & Apple Pascal **\$1995**

5 1/4" DISK DRIVE

Use with standard Apple II disk controller. **\$295**

5 1/4" FLOPPY DISKS

With hub rings. Box of 10.
With other purchase **\$19.95**
Without purchase **\$23.00**

16K MEMORY EXPANSION MODULE

The preferred 16K RAM Expansion Module from PROMETHEUS. Fully compatible with CP/M* and Apple Pascal*. With full 1-year parts and labor warranty. (List: \$169) **\$75**

WORD PROCESSING SPECIAL WITH WORDSTAR AND SUPERCALC!

Do professional word processing on your APPLE. All necessary hardware and software included. Complete 80 column video display, enhanced character set, 16K memory board, Z-Card with CP/M* software, Wordstar and word processing software and SuperCALC.
(List: \$1,128) **Special at \$695**



from Prometheus! ExpandaRAM

The only 128K RAM card that lets you start with 16K, 32K, or 64K of memory now and expand to the full 128K later. Fully compatible with Apple Pascal, CP/M*, and Visacalc. No Apple modification required. Memory management system included with all ExpandaRAMs. Disk emulators included with 64K and 128K versions.

- MEM-32 Two rows of 16K RAMS**
make a 32K RAM Card **\$209**
- MEM-64 One row of 64K RAM.**
With DOS 3.3 disk emulator **\$299**
- MEM-128 Two rows of 64K RAMS installed**
make a 128K Card.
With DOS 3.3 disk emulator **\$399**
- MEM-RKT 64K RAM Add-On-Kits—**
64K Dynamic RAMS. Each **\$125**
- VISICALC Expansion Program**
for MEM-128 **\$75**
- MEM-PSL Pascal disk emulator for**
MEM-128 **\$45**

MODEMS FOR YOUR APPLE II

- HAYES Smartmodem **\$229**
- MICROMODEM II **\$279**



VERSACard FROM PROMETHEUS

Four cards on one! With true simultaneous operation. Includes: (1) Serial Input/Output Interface, (2) Parallel Output Interface, (3) Precision Clock/Calendar, and (4) BSR Control. All on one card. Fully compatible with CP/M* and Apple Pascal*.
(List: \$249) **\$169**



80 COLUMN VIDEO DISPLAYS FOR APPLE II SMARTERM

(Not to be confused with SUPRTERM)

Software switching from 80 to 40 and 40 to 80 characters. 9 new characters not found on the Apple keyboard. Fully compatible with CP/M* and Apple PASCAL*. With lowest power consumption of only 2.5 watts.

(List: \$345) **\$225**

SMARTERM EXPANDED CHARACTER SET

7" x 11" matrix with true decenders. Add to above **\$40**

Best Buy! Combination SMARTERM and EXPANDED CHARACTER SET

- Special at **\$260**
- VIDEX, VIDEOTERM **\$249**
- VIDEX ENHANCER II **\$119**



CENTRONICS COMPATIBLE PARALLEL INTERFACE

From PROMETHEUS. For use with Epson, NEC, C-ITOH, and other printers. Fully compatible with CP/M* and Apple Pascal*.

PRT-1, Only **\$69**

GRAPHITTI CARD

Prints HIRES page 1 or 2 from onboard firmware. Features: True 1:1 aspect ratio, prints emphasized mode, reverse mode, rotates 90 degrees ... plus more. Compare all this with the Grappler. We think you'll agree that this is the best graphics card on the market. Specify for use with EPSON, NEC-8023, C-ITOH Prowriter, or Okidata.
(List: \$125) **\$89**

SOFTWARE

- WORDSTAR **Special at \$195**
- SPELLSTAR **\$125**
- SUPERCALC **\$175**
- D BASE II **\$525**
- VISICALC **\$149**
- DB MASTER **\$189**

All equipment shipped factory fresh. Manufacturers' warranties included. Please add \$3.00 per product for shipping and handling. California: add 6% tax. BART Counties: 6 1/2%.

All items are normally in stock

Phone for Quick Shipment!

(415) 490-3420

... And we'll be here to help after you receive your order. Feel free to call the SGC Technical Staff for assistance.

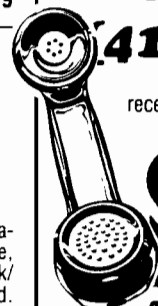

The mail order specialists

342 Quartz Circle, Livermore, CA 94550

68000

Binary Arithmetic Operations

by Joe Hootman

A short discussion of the various instructions for binary arithmetic including addressing and sign information.

The most extensive list of instructions, and some of the most frequently used, are the Binary Arithmetic Operations (table 1). Most of the binary operations are straightforward however, there are several instructions unique to the 68000.

The binary operations usually do not apply to operations on the address registers. However, in the binary arithmetic instruction implementation of the 68000, there are several instructions such as ADDA, CMPA, and SUBA that are designed for operation on the address register. The operations on the address register allow special addressing operations to be carried out and, more importantly, allow the comparison of the magnitude of the address register without using the CHK instruction. Clearly the address registers can be used as data registers or index registers. Three instructions deal with sign extension: ADDX, EXT, and NEGX. All of the sign extension instructions sense the sign bit of the operation and the sign is extended through the length of the word.

When arithmetic instructions are considered, the implementation of the signed multiply and divide and the unsigned multiply and divide must be considered a most worthwhile and powerful addition to the instruction set. The signed and unsigned multiply and divide instructions are all 16-bit instructions. The data to be operated on is a word in length; the result of the operation is 32 bits long (long word). The interpretation of the 32 bits depends on the particular instruction. For example, if D0 contains \$8055, D1 contains \$0002, and MULS D1, D0 is executed, the result (\$FFFF00AA) will

be left in data register D0. Since the most significant bit of the word is set, this indicates that the result is negative and the N bit is set in the CCR. If D0 contains \$8055, D1 contains \$0002, and MULU D1, D0 is executed, then the result (\$000100AA) will be in D0.

The signed and unsigned divide have characteristics similar to the multiply instructions. If division by zero is attempted, a trap will occur and overflow is indicated by the state of the V bit in the CCR. If Z is set then the

quotient is zero. The N bit follows the most significant bit of the result. In both the signed and unsigned divide the quotient is the lower 16 bits of the destination register and the upper 16 bits is the remainder. The sign is reflected by the most significant bit of the result.

The TST instruction subtracts the designated data from zero and the appropriate bits set in the CCR. This instruction testing of byte, word, and long word data is reflected in the CCR.

Table 1: Binary Arithmetic Operations

*The addressing modes will be covered in future issues.

Mnemonic	Data Size/CCR	Function	Comments																																																																												
ADD	8, 16, 32 CCR X N Z V C * * * * *	Add Binary	<p>This operation adds the binary data designated by the source to the data designated by the destination and leaves the result in the destination. If the effective address is a source then all addressing modes can be used.</p> <p>Opword Format</p> <table border="1"> <tr> <td>15</td><td>14</td><td>13</td><td>12</td><td>11</td><td>10</td><td>9</td><td>8</td><td>7</td><td>6</td><td>5</td><td>4</td><td>3</td><td>2</td><td>1</td><td>0</td> </tr> <tr> <td>1</td><td>1</td><td>0</td><td>1</td><td></td><td></td><td></td><td></td><td></td><td></td><td></td><td></td><td></td><td></td><td></td><td></td> </tr> <tr> <td></td><td></td><td></td><td></td><td></td><td></td><td></td><td></td><td></td><td></td><td></td><td></td><td></td><td></td><td></td><td></td> </tr> <tr> <td></td><td></td><td></td><td></td><td></td><td></td><td></td><td></td><td></td><td></td><td></td><td></td><td></td><td></td><td></td><td></td> </tr> </table> <p>Register — Any of the eight data registers.</p> <p>Op Mode</p> <table border="1"> <tr> <td>Byte</td><td>Word</td><td>Long Word</td><td>Operation</td> </tr> <tr> <td>000</td><td>001</td><td>010</td><td>Dn + EA → Dn</td> </tr> <tr> <td>100</td><td>101</td><td>110</td><td>EA + Dn → EA</td> </tr> </table> <p>The source can have all the address modes except 13, 14.*</p> <p>The destination can have all the address modes except 1, 2, 10, 11, 12, 13, 14.*</p>	15	14	13	12	11	10	9	8	7	6	5	4	3	2	1	0	1	1	0	1																																													Byte	Word	Long Word	Operation	000	001	010	Dn + EA → Dn	100	101	110	EA + Dn → EA
15	14	13	12	11	10	9	8	7	6	5	4	3	2	1	0																																																																
1	1	0	1																																																																												
Byte	Word	Long Word	Operation																																																																												
000	001	010	Dn + EA → Dn																																																																												
100	101	110	EA + Dn → EA																																																																												
ADDA	16, 32 CCR X N Z V C * * * * *	Add Address	<p>This instruction adds the source data to the designated address register and leaves the result in the address register.</p> <p>15 14 13 12 11 10 9 8 7 6 5 4 3 2 1 0</p> <table border="1"> <tr> <td>1</td><td>1</td><td>0</td><td>1</td><td></td><td></td><td></td><td></td><td></td><td></td><td></td><td></td><td></td><td></td><td></td><td></td> </tr> <tr> <td></td><td></td><td></td><td></td><td></td><td></td><td></td><td></td><td></td><td></td><td></td><td></td><td></td><td></td><td></td><td></td> </tr> <tr> <td></td><td></td><td></td><td></td><td></td><td></td><td></td><td></td><td></td><td></td><td></td><td></td><td></td><td></td><td></td><td></td> </tr> <tr> <td></td><td></td><td></td><td></td><td></td><td></td><td></td><td></td><td></td><td></td><td></td><td></td><td></td><td></td><td></td><td></td> </tr> </table> <p>The register field can be any of the 8 address registers. This is always the destination.</p> <p>Op Mode</p> <table border="1"> <tr> <td>011</td><td>Word operation the sign will be extended to all 32 bits of the address register.</td> </tr> <tr> <td>111</td><td>Long operation</td> </tr> </table> <p>All addressing modes are allowed except 13, 14.*</p>	1	1	0	1																																																													011	Word operation the sign will be extended to all 32 bits of the address register.	111	Long operation								
1	1	0	1																																																																												
011	Word operation the sign will be extended to all 32 bits of the address register.																																																																														
111	Long operation																																																																														

(continued)

Mnemonic Data Size/CCR Function Comments

ADDI 8, 16, 32 Add This instruction adds immediate data to the
CCR Immediate destination data and leaves the result in the
X N Z V C destination.
* * * * *

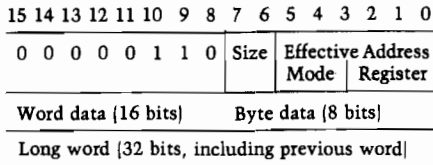

Size field: 00 - Byte
01 - Word
10 - Long word
All addressing modes except 10, 11, 12, 13, 14 can be used as a destination.*

ADDQ 8, 16, 32 Add This instruction allows the binary addition of
CCR Quick any data from 1 to 8.
X N Z V C
* * * * *

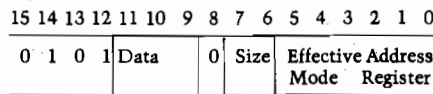

The data field can contain any integer from 1 to 7.
Size field: 00 - Byte
01 - Word
10 - Long word
All addressing modes except 10, 11, 12, 13, and 14 can be used as a destination.*

ADDX 8, 16, 32 Add This instruction adds the source to the
CCR Extended destination and leaves the result in the
X N Z V C destination. The sign bit of the result is
* * * * * extended to fill the word.

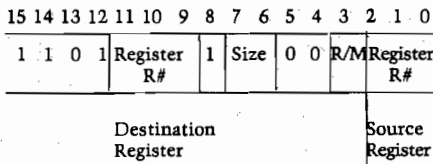

Register field R# designates any one of eight registers.
If R/M = 0 then a data register is specified.
If R/M = 1 then an address register is specified.
Size field: 00 - Byte operation
01 - Word operation
10 - Long word operation

CLR 8, 16, 32 Clear an This instruction clears the effective address.
CCR Operand
X N Z V C
- 0 1 0 0

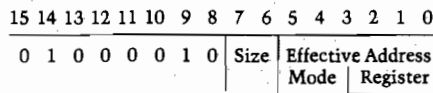

Size field: 00 - Byte operation
01 - Word operation
10 - Long word operation
The following address modes cannot be used as destinations: 2, 10, 11, 12, 13, 14.*

MICRObits

Deadline for MICRObits: 20th of second month before publication; i.e., November 20th for January issue. Send typewritten copy (40-word limit) with \$25.00 per insertion. (Subscribers: first ad at \$10.00.)

6800/6809 Software

Includes compatible single-user, multi-user and network-operating systems, compilers, accounting and word processing packages. Free catalog.

Software Dynamics
2111 W. Crescent, Sta. G
Anaheim, CA 92801

Lessons in Algebra

An easy and fun way to learn the basic elements of high school algebra. Apple computer diskette \$29.95. 30-day money-back guarantee if not satisfied.

George Earl
1302 So. General McMullen Dr.
San Antonio, TX 78237

PET Joystick Interface

Connects directly to all PET/CBM computers. Allows PET to accept either Apple joysticks/paddles or Atari joysticks. No assembly required. Ready to plug into the user port. Software provided. Immediate delivery. Only \$49.95. Michigan residents add 4% sales tax.

J. Systems Corp.
1 Edmund Place
Ann Arbor, MI 48103

OAI 65D V3.3 Guide

Contains fixes and other data OSI didn't tell you about. Increase compatibility between 65DV3.X and VB.3. Run extended utilities under V3.3 and more. \$14.95. New York residents add 7% sales tax.

Buffalo Informational Technologies
209 Richmond Avenue
Buffalo, NY 14222

VIC 20 Games — 5 for \$10.00

Tape 1: Canon Duel, Breakout, Runaround, Stockcar, Space Scout. Tape 2: Target Pistol, Space Duel, B29, Tank, Roadblock. Tape 3: Sub Hunt, Blockade, Indy500, UFO, Jungle Driver. Add \$1.50 for p/h. All 15 games for \$25.00.

Skylight Software
22 Miller St.
Belfast, ME 04915

(Continued on page 30)

Table 1 (continued)

Mnemonic	Data Size/CCR	Function	Comments																													
CMP	8, 16, 32 CCR X N Z V C -	Compare	This operation subtracts from the destination the source; the destination is not changed.																													
			<table border="1"> <tr> <td>15</td><td>14</td><td>13</td><td>12</td><td>11</td><td>10</td><td>9</td><td>8</td><td>7</td><td>6</td><td>5</td><td>4</td><td>3</td><td>2</td><td>1</td><td>0</td> </tr> <tr> <td>1</td><td>0</td><td>1</td><td>1</td><td>Register</td><td>Op Mode</td><td>Effective Address Mode</td><td>Register</td><td colspan="8"></td> </tr> </table> <p>Register field defines the destination data register.</p> <p>Op Mode field defines the size of the data to be compared.</p> <p>000 - Byte 001 - Word 010 - Long word</p> <p>All but the Quick Immediate and Implied addressing can be used for an effective address 13, 14.*</p>	15	14	13	12	11	10	9	8	7	6	5	4	3	2	1	0	1	0	1	1	Register	Op Mode	Effective Address Mode	Register					
15	14	13	12	11	10	9	8	7	6	5	4	3	2	1	0																	
1	0	1	1	Register	Op Mode	Effective Address Mode	Register																									
CMPA	16, 32 CCR X N Z V C -	Compare Addresses	This instruction subtracts the effective address from the destination and leaves the destination unchanged.																													
			<table border="1"> <tr> <td>15</td><td>14</td><td>13</td><td>12</td><td>11</td><td>10</td><td>9</td><td>8</td><td>7</td><td>6</td><td>5</td><td>4</td><td>3</td><td>2</td><td>1</td><td>0</td> </tr> <tr> <td>1</td><td>0</td><td>1</td><td>1</td><td>Register</td><td>Op Mode</td><td>Effective Address Mode</td><td>Register</td><td colspan="8"></td> </tr> </table> <p>Register field defines the destination address register.</p> <p>Op Mode field specifies the size of the operand.</p> <p>011 - Word operator 111 - Long word</p> <p>All effective addressing modes except the implied mode can be used.</p>	15	14	13	12	11	10	9	8	7	6	5	4	3	2	1	0	1	0	1	1	Register	Op Mode	Effective Address Mode	Register					
15	14	13	12	11	10	9	8	7	6	5	4	3	2	1	0																	
1	0	1	1	Register	Op Mode	Effective Address Mode	Register																									
CMPI	8, 16, 32 CCR X N Z V C -	Compare Immediate	This instruction subtracts the immediate data from the destination. The condition codes a set consistent with the results of the operation.																													
			<table border="1"> <tr> <td>15</td><td>14</td><td>13</td><td>12</td><td>11</td><td>10</td><td>9</td><td>8</td><td>7</td><td>6</td><td>5</td><td>4</td><td>3</td><td>2</td><td>1</td><td>0</td> </tr> <tr> <td>0</td><td>0</td><td>0</td><td>0</td><td>1</td><td>1</td><td>0</td><td>0</td><td>Size</td><td>Effective Address Mode</td><td>Register</td><td colspan="5"></td> </tr> </table> <p>Word data (16 bits) Byte data (8 bits)</p> <p>Long data (32 bits including previous word)</p> <p>Size field: 00 - Byte operation 01 - Word operation 10 - Long word operation</p> <p>The following destination effective addresses cannot be used: 2, 10, 11, 12, 13, 14.*</p>	15	14	13	12	11	10	9	8	7	6	5	4	3	2	1	0	0	0	0	0	1	1	0	0	Size	Effective Address Mode	Register		
15	14	13	12	11	10	9	8	7	6	5	4	3	2	1	0																	
0	0	0	0	1	1	0	0	Size	Effective Address Mode	Register																						
CMPM	8, 16, 32 CCR X N Z V C -	Compare Memory	This operation is used to subtract the source from the destination. The CCR is set in accord with the result. The contents of the destination are not changed. The addressing is always done using postincrement addressing.																													
			<table border="1"> <tr> <td>15</td><td>14</td><td>13</td><td>12</td><td>11</td><td>10</td><td>9</td><td>8</td><td>7</td><td>6</td><td>5</td><td>4</td><td>3</td><td>2</td><td>1</td><td>0</td> </tr> <tr> <td>1</td><td>0</td><td>1</td><td>1</td><td>Register Rx</td><td>1</td><td>Size</td><td>0</td><td>0</td><td>1</td><td>Register Ry</td><td colspan="5"></td> </tr> </table> <p>Rx must be an address register and in the destination.</p> <p>Ry must be an address register and is always the source.</p> <p>Only the Post Increment mode can be used.</p>	15	14	13	12	11	10	9	8	7	6	5	4	3	2	1	0	1	0	1	1	Register Rx	1	Size	0	0	1	Register Ry		
15	14	13	12	11	10	9	8	7	6	5	4	3	2	1	0																	
1	0	1	1	Register Rx	1	Size	0	0	1	Register Ry																						

(continued)

A harvest of savings from



Apple Tree Electronics

SOFTWARE

APPLE • ATARI • TRS80 • IBM
A full line of software for business, games and education **up to 35% off!**

- | | |
|----------|---------------|
| MUSE | KIS |
| VISICORP | STONEWARE |
| ON LINE | SYNERGISTIC |
| EDU-WARE | HAYDEN |
| HOWARD | AND MANY MORE |

HARDWARE

AMDEK • HAYES • MICROSOFT

FRANKLIN COMPUTER SYSTEM

ACE 1000 • \$1,795.00

DISKS

- Maxell Box of 10, 5 1/4" SS-DD \$35.00
Verbatim Box of 10, 5 1/4" SS-DD \$29.00

MONITORS

LE MONITORS	List	Our Price
9" Green	\$189.00	\$159.00
12" Green	\$199.00	\$169.00
ZENITH		
12" Green	\$179.00	\$129.00

Plus a full line of AMDEK Monitors

PRINTERS

PAPER TIGER	List	Our Price
460G	\$1,094.00	\$950.00
560G	\$1,394.00	\$1,250.00
EPSON		
MX 70	\$449.00	\$395.00
MX 80FT	\$745.00	\$595.00
MX 100FT	\$945.00	\$795.00

CALL FOR THIS MONTHS SPECIAL!

1-800-835-2246 EXT. 211
OR
702-459-4114

5130 East Charleston Blvd.
Suite 5M
Las Vegas, Nevada 89122

Phone orders welcome. Mail orders may send charge card number (include expiration date), cashiers check, money order or personal check (allow ten business days for personal or company checks to clear). Add \$3.00 for shipping, handling and insurance. Nevada residents add 5.75% sales tax. Please include phone number. All equipment is in factory cartons with manufacturers warranty. Equipment subject to price change and availability. Call or write for price list.

MICRObits

(Continued from page 28)

Elephant Disks

5¼" SS/SD \$21/box, SS/DD (48 TPI) \$24/box, SS/DD (96 TPI) and DS/DD (48 TPI) \$30/box, DS/DD (96 TPI) \$36/box. Write for prices on 8". Add \$1 per order shipping via UPS in USA, NJ add 5% sales tax.

Baker Enterprises
15 Windsor Drive
Atco, NJ 08004

SYM-1 Computer Plus 6502 Books

SYM-1 assembled and tested, never used (original packing). SYM programming manual and reference manual included - \$130.00. PMC (EMA 5/6B) power supply - \$19.95 (cable connection for SYM included). 6502 software design [L.J. Scanlon] - \$8.95 new. Programming and interfacing 6502 with experiments [M.L. Defjong] - \$10.95 new. SASE:

Frank Janda
19 Wilson Drive
Framingham, MA 01701
(617) 862-3120 ext.209

OSI Super Defender

Play this great arcade game at home. All machine code includes: scanner; smart bombs; laser fire; moving mountains and more. Save your humanoids from the alien landers. Very smooth (half character moves) graphics. \$14.95 for C1,2,4 tape or 5¼" disk.

DMP Systems
319 Hampton Blvd.
Rochester, NY 14612

Commodore 64 Software

Sprite Editor - \$12, Dumb Terminal - \$10, Disassembler - \$15, Cross-Reference Generator for BASIC programs - \$10. Descriptive catalogue - 50 cents. Contact by US mail or CompuServe 70140,223.

NEON SYSTEMS
5108 N. 23rd Road
Arlington, VA 22207

The Wrath of Khan

Can you defeat a Superman? Command Enterprise in a tactical battle against the Reliant. C1-P controls Reliant's maneuvers and weapons via Artificial Intelligence logic routines. Features full status display, sensors, photon torpedoes, phasers, deflectors, and more. Cassette 8K - \$14.95 ppd.

Cygnus Software
791 W. Oakland Park Blvd.
Suite 432
Ft. Lauderdale, FL 33311

Table 1 (continued)

Mnemonic	Data Size/CCR	Function	Comments																																
DIVS	16 CCR X N Z V C - * * * 0	Signed Divide	This operation divides the destination by the source. The result is left in the destination. The source is a 16-bit word and the destination is a long word operation. The lower 16 bits are the quotient and the remainder is in the upper 16 bits; the sign of the remainder is the same as dividend unless the remainder is zero. Division by zero causes a trap. Overflow may be detected and flagged but the operation is unaffected. <table border="1"> <tr> <td>15</td><td>14</td><td>13</td><td>12</td><td>11</td><td>10</td><td>9</td><td>8</td><td>7</td><td>6</td><td>5</td><td>4</td><td>3</td><td>2</td><td>1</td><td>0</td> </tr> <tr> <td>1</td><td>0</td><td>0</td><td>0</td><td>Register #</td> <td>1</td><td>1</td><td>1</td><td>Effective Address Mode</td> <td>Register</td> <td></td><td></td><td></td><td></td><td></td><td></td> </tr> </table> <p>The register # specifies one of the eight data registers and this is the destination register. The effective address determines the source and all EA modes can be used except 2, 14.*</p>	15	14	13	12	11	10	9	8	7	6	5	4	3	2	1	0	1	0	0	0	Register #	1	1	1	Effective Address Mode	Register						
15	14	13	12	11	10	9	8	7	6	5	4	3	2	1	0																				
1	0	0	0	Register #	1	1	1	Effective Address Mode	Register																										
DIVU	16 CCR X N Z V C - * * * 0	Unsigned Divide	The unsigned divide is identical to the signed divide except that unsigned arithmetic is used. <table border="1"> <tr> <td>15</td><td>14</td><td>13</td><td>12</td><td>11</td><td>10</td><td>9</td><td>8</td><td>7</td><td>6</td><td>5</td><td>4</td><td>3</td><td>2</td><td>1</td><td>0</td> </tr> <tr> <td>1</td><td>0</td><td>0</td><td>0</td><td>Register #</td> <td>0</td><td>1</td><td>1</td><td>Effective Address Mode</td> <td>Register</td> <td></td><td></td><td></td><td></td><td></td><td></td> </tr> </table> <p>The addressing modes and the definition in the opword are the same as the signed divide.</p>	15	14	13	12	11	10	9	8	7	6	5	4	3	2	1	0	1	0	0	0	Register #	0	1	1	Effective Address Mode	Register						
15	14	13	12	11	10	9	8	7	6	5	4	3	2	1	0																				
1	0	0	0	Register #	0	1	1	Effective Address Mode	Register																										
EXT	16, 32 CCR X N Z V C - * * 0 0	Sign Extend	This instruction extends the sign bit of a byte to a word or a word to a long word. The MSB is detected and extended to the proper length. The sign bit is considered to be the most significant bit of the word. <table border="1"> <tr> <td>15</td><td>14</td><td>13</td><td>12</td><td>11</td><td>10</td><td>9</td><td>8</td><td>7</td><td>6</td><td>5</td><td>4</td><td>3</td><td>2</td><td>1</td><td>0</td> </tr> <tr> <td>0</td><td>1</td><td>0</td><td>0</td><td>1</td><td>0</td><td>0</td><td>Op Mode</td> <td>0</td><td>0</td><td>0</td><td>Register</td> <td></td><td></td><td></td><td></td> </tr> </table> <p>Op-Mode field specifies the size of the extension. 010 - Word sign extension 011 - Long word sign extension Register field specifies one of eight data registers.</p>	15	14	13	12	11	10	9	8	7	6	5	4	3	2	1	0	0	1	0	0	1	0	0	Op Mode	0	0	0	Register				
15	14	13	12	11	10	9	8	7	6	5	4	3	2	1	0																				
0	1	0	0	1	0	0	Op Mode	0	0	0	Register																								
MULS	16 CCR X N Z V C - * * 0 0	Signed Multiply	This operation multiplies two signed words together. The destination must be a specified data register. The sign of the operation is reflected in the sign bit. <table border="1"> <tr> <td>15</td><td>14</td><td>13</td><td>12</td><td>11</td><td>10</td><td>9</td><td>8</td><td>7</td><td>6</td><td>5</td><td>4</td><td>3</td><td>2</td><td>1</td><td>0</td> </tr> <tr> <td>1</td><td>1</td><td>0</td><td>0</td><td>Register</td> <td>1</td><td>1</td><td>1</td><td>Effective Address Mode</td> <td>Register</td> <td></td><td></td><td></td><td></td><td></td><td></td> </tr> </table> <p>Register field specifies one of the data registers and is a destination register. All effective addressing modes can be used except Direct, Quick, Immediate, and Implied 2, 13, 14.*</p>	15	14	13	12	11	10	9	8	7	6	5	4	3	2	1	0	1	1	0	0	Register	1	1	1	Effective Address Mode	Register						
15	14	13	12	11	10	9	8	7	6	5	4	3	2	1	0																				
1	1	0	0	Register	1	1	1	Effective Address Mode	Register																										
MULU	16 CCR X N Z V C - * * 0 0	Unsigned Multiply	This operation multiplies two 16-bit integers together and leaves the result in the destination register. The operations are similar to the signed multiply except that signed arithmetic is not used. The 32-bit result is left in the destination register. <table border="1"> <tr> <td>15</td><td>14</td><td>13</td><td>12</td><td>11</td><td>10</td><td>9</td><td>8</td><td>7</td><td>6</td><td>5</td><td>4</td><td>3</td><td>2</td><td>1</td><td>0</td> </tr> <tr> <td>1</td><td>1</td><td>0</td><td>0</td><td>Register</td> <td>0</td><td>1</td><td>1</td><td>Effective Address Mode</td> <td>Register</td> <td></td><td></td><td></td><td></td><td></td><td></td> </tr> </table> <p>Register field specifies one of eight data registers. The effective address can be anything but Direct, Quick, Immediate, and Implied 2, 13, 14.*</p>	15	14	13	12	11	10	9	8	7	6	5	4	3	2	1	0	1	1	0	0	Register	0	1	1	Effective Address Mode	Register						
15	14	13	12	11	10	9	8	7	6	5	4	3	2	1	0																				
1	1	0	0	Register	0	1	1	Effective Address Mode	Register																										

(continued)

Table 1 (continued)

Mnemonic	Data Size/CCR	Function	Comments																													
NEG	8, 16, 32 CCR X N Z V C * * * * *	Negate	<p>The destination is subtracted from zero. This changes the sign of the destination. The result of this operation is left in the destination.</p> <p>15 14 13 12 11 10 9 8 7 6 5 4 3 2 1 0</p> <table border="1"> <tr> <td>0</td><td>1</td><td>0</td><td>0</td><td>0</td><td>1</td><td>0</td><td>0</td> <td>Size</td> <td>Effective Address</td> </tr> <tr> <td></td><td></td><td></td><td></td><td></td><td></td><td></td><td></td> <td>Mode</td> <td>Register</td> </tr> </table> <p>Size field specifies the size of the data to be operated on. 00 - Byte operation 01 - Word operation 10 - Long word operation</p> <p>Effective address modes can be anything but 2, 10, 11, 12, 13, 14.*</p>	0	1	0	0	0	1	0	0	Size	Effective Address									Mode	Register									
0	1	0	0	0	1	0	0	Size	Effective Address																							
								Mode	Register																							
NEGX	8, 16, 32 CCR X N Z V C * * * * *	Negate with Extend	<p>The destination is subtracted from zero and the result of the operation is left in the destination. The sign bit is extended to the end of the word.</p> <p>15 14 13 12 11 10 9 8 7 6 5 4 3 2 1 0</p> <table border="1"> <tr> <td>0</td><td>1</td><td>0</td><td>0</td><td>0</td><td>0</td><td>0</td><td>0</td> <td>Size</td> <td>Effective Address</td> </tr> <tr> <td></td><td></td><td></td><td></td><td></td><td></td><td></td><td></td> <td>Mode</td> <td>Register</td> </tr> </table> <p>Size field specifies the size of the operation. 00 - Byte operation 01 - Word operation 10 - Long word operation</p> <p>The following effective address modes cannot be used: 2, 10, 11, 12, 13, 14.*</p>	0	1	0	0	0	0	0	0	Size	Effective Address									Mode	Register									
0	1	0	0	0	0	0	0	Size	Effective Address																							
								Mode	Register																							
SUB	8, 16, 32 CCR X N Z V C * * * * *	Subtract Binary	<p>This operation subtracts the source from the destination and leaves the result in the destination.</p> <p>15 14 13 12 11 10 9 8 7 6 5 4 3 2 1 0</p> <table border="1"> <tr> <td>1</td><td>0</td><td>0</td><td>1</td> <td>Register</td> <td>Op Mode</td> <td>Effective Address</td> </tr> <tr> <td></td><td></td><td></td><td></td> <td></td> <td></td> <td>Mode Register</td> </tr> </table> <p>Register field specifies any one of the eight data registers. Op Mode field defines the way that the operation is to be performed between the data register and the effective address.</p> <table border="1"> <tr> <td></td><td></td><td>Long</td> </tr> <tr> <td>Byte</td><td>Word</td><td>Word</td><td>Operation</td> </tr> <tr> <td>000</td><td>001</td><td>010</td><td>The data register is the destination and the EA is subtracted from the Register.</td> </tr> <tr> <td>100</td><td>101</td><td>110</td><td>The EA is the destination and the register is subtracted from the EA.</td> </tr> </table> <p>The only effective address (EA) modes which cannot be used if the EA is a source are 13, 14.* If the EA is a destination then the following effective address modes cannot be used: 1, 2, 10, 11, 12, 13, 14.*</p>	1	0	0	1	Register	Op Mode	Effective Address							Mode Register			Long	Byte	Word	Word	Operation	000	001	010	The data register is the destination and the EA is subtracted from the Register.	100	101	110	The EA is the destination and the register is subtracted from the EA.
1	0	0	1	Register	Op Mode	Effective Address																										
						Mode Register																										
		Long																														
Byte	Word	Word	Operation																													
000	001	010	The data register is the destination and the EA is subtracted from the Register.																													
100	101	110	The EA is the destination and the register is subtracted from the EA.																													
SUBA	16, 32 CCR X N Z V C * * * * *	Subtract Address	<p>This instruction subtracts the effective address from the address register and leaves the result in the address register.</p> <p>15 14 13 12 11 10 9 8 7 6 5 4 3 2 1 0</p> <table border="1"> <tr> <td>1</td><td>0</td><td>0</td><td>1</td> <td>Register</td> <td>Op Mode</td> <td>Effective Address</td> </tr> <tr> <td></td><td></td><td></td><td></td> <td></td> <td></td> <td>Mode Register</td> </tr> </table> <p>Register field specifies any one of the eight address registers. The Op Mode specifies the size of the operation. 011 - Word operation 111 - Long word operation</p> <p>All effective address modes can be used except 10, 11, 12, 13, 14.*</p>	1	0	0	1	Register	Op Mode	Effective Address							Mode Register															
1	0	0	1	Register	Op Mode	Effective Address																										
						Mode Register																										

(continued)

MICRObits (continued)

VisiCalc To Apple Plot

Interface translates from VisiCalc to Apple Plot, prevents erroneous graphs, fits curves to data, and supplements VisiCalc with rank ordering and alphabetizing. Send SASE for details or \$30.00 for the copyable program.

Bill Starbuck
 2100 E. Edgewood
 Shorewood, WI 53211
 (414) 963-9750

VisiCalc To Apple Writer

Veecee-Writer translated VisiCalc (/PF) files for Apple Writer 1. Send \$15.00 for the copyable program.

Bill Starbuck
 2100 E. Edgewood
 Shorewood, WI 53211
 (414) 963-9750

AIM-65 FIG-FORTH

Fig-Forth for your Aim-65 with assembler needs 16K memory. Cassette \$20.00. With editor and assembler needs 32K memory \$25.00.

D. Holmes
 466 Palos Verdes Blvd.
 Redondo Beach, CA 90277

OSI-C3B

152K static ram, 70 MB disk, 160 lpm printer, dual 8" floppies, software, 1 year old, used 2 months. \$12,800.00 US or best offer.

Alan J. Lawson
 Toronto, Canada
 (416) 576-6508

OSI C1P Chomper

Positively one of the most difficult, challenging, and fun dot-eating games available on the C1P. Progressively faster action, bonus characters, and "commercials" for high scores. Keyboard or joystick, 8K tape. \$14.95 includes shipping.

Watts Ware
 153 Madrona Drive
 Anacortes, WA 98221

Consulting Opportunities

Learn how to become a successful consultant in your own field. Write for a free prospectus:

The Consultant's Library
 815 15th Street, NW Dept. M.
 Washington D.C. 20005



Announcing THE GUIDE

A Complete Guide
to the Apple Computer



If You Own the Original
**What's Where in the
APPLE?**
You Will Want
THE GUIDE
A Complete Guide
to the Apple Computer
only \$9.95*

The Guide provides full explanatory text to lead you through the most complete Apple memory map ever published!

The Guide explains and demonstrates how to use the atlas and gazeteer published in the original volume!

If you missed the first edition of **What's Where in the Apple?**, a new revised edition containing **BOTH** the original atlas and gazeteer **AND** the all new Guide is available in one 256-page, Wire-O-Bound book for only \$24.95!

*MICRO makes it easy to order:
Send check (payable to MICRO) to:*

MICRO INK

P.O. Box 6502

Chelmsford, MA 01824

Call our toll-free number:

1-800-345-8112

(In PA, 1-800-662-2444)

VISA and MasterCard accepted

*Add \$2.00 shipping per book.

MA residents add 5%.

83-370

Mnemonic	Data Size/CCR	Function	Comments
SUBL	8, 16, 32 CCR X N Z V C * * * * *	Subtract Immediate	This instruction subtracts the immediate data from the destination. The result of the operation is left in the destination and the proper bits are set in the CCR. 15 14 13 12 11 10 9 8 7 6 5 4 3 2 1 0 0 0 0 0 0 1 0 0 Size Effective Address Mode Register Word data (16 bits) Byte data (8 bits) Long word data (32 bits using previous word) Size field defines the size of the operation. 00 - Byte operation data is the lower order byte of the immediate word. 01 - Word operation data is the entire immediate word. 10 - Long word operation data is the next two immediate words. The following addressing modes cannot be used: 2, 10, 11, 12, 13, 14.*
SUBQ	8, 16, 32 CCR X N Z V C * * * * *	Subtract Quick	This operation subtracts the immediate data from the destination. The results are left in the destination and the bits are set in the CCR consistent with the results of the operation. 15 14 13 12 11 10 9 8 7 6 5 4 3 2 1 0 0 1 0 1 Data 1 Size Effective Address Mode Register Data field contains the immediate data to be subtracted: Any integer from 1 - 7 can be represented and 0 in the data field represents the integer 8. Size field determines the size of the operation. 00 - Byte operation 01 - Word operation 10 - Long word operation The following effective address modes cannot be used: 10, 11, 12, 13, 14.*
SUBX	8, 16, 32 CCR X N Z V C * * * * *	Subtract with Extension	This instruction subtracts the source from the destination and leaves the results in the destination. The sign is extended. 15 14 13 12 11 10 9 8 7 6 5 4 3 2 1 0 1 0 0 1 Register Rx 1 Size 0 0 R/M Register Ry Size field specifies the size of the operation. 00 - Byte operation 01 - Word operation 10 - Long word operation Rx destination register R/M = 0 data register R/M = 1 address register for predecrement mode Ry source register data register address register for predecrement mode data register to data register transfer memory to memory transfer
TST	8, 16, 32 CCR X N Z V C - * * 0 0	Test an Operand	This instruction compares the data defined by the effective address with zero. The condition code register is set to be consistent with the result of the operation. 15 14 13 12 11 10 9 8 7 6 5 4 3 2 1 0 0 1 0 0 1 0 1 0 Size Effective Address Mode Register 00 - Byte operation 01 - Word operation 10 - Long word operation The following effective address modes cannot be used: 2, 10, 11, 12, 13, 14.*

MICRO

...ing like it before. Nothing else like it now!

... brings you continuous Hi-Res action-animation in every adventurous moment! And, real running, leaping, crawling. Real fighting, shooting, stabbing, dynamiting. Real wounding, poisoning, killing. Real action, excitement, mystery! All in a real-time challenging adventure that's the wave of the future!

Paul Stevenson's graphic genius, first displayed in his best selling "Swashbuckler" sword fighting game, outdoes itself in AZTEC. You're inside an ancient Aztec pyramid searching for the golden idol. Descend deep into the heart of the temple—meet cobras, scorpions, giant lizards, hostile Aztec guardians and more. Watch for hidden trapdoors and strange death-rooms. Be ready to fight, or run, crawl or jump to possible safety. The menace is real, the options and strategy are yours. You've never seen an adventure like Aztec! You'll never tire of its amazing action-animation and exciting challenge. \$39.95 for the Apple II.* At your computer store or:

 DATAMOST

9748 Cozycroft Ave., Chatsworth, Ca 91311 (213) 709-1202

AZTEC



VISA MASTERCARD accepted. \$2.00 shipping handling charge. (California residents add 6% sales tax.)

The arcade-warp is open!

YOU CAN RUN BUT CAN'T HIDE. YOU CAN KILL BUT CAN'T ESCAPE.

Tubeway! It's an insidious invasion realm created by beings from a parallel universe—a strange, geometric universe. You're trapped on the rim as their fleet swarms out of the warp.

on a voyage of discovery and conquest. The battle is yours to win or lose—alone—and it's far from easy because no strategy doesn't work. ... you have to fight them on their terms, their strange, geometric rules!

Here's the fastest, most fascinating of the new style space games involving and exciting. It's destined to become an all-star, all-time hit, one of the first to take the challenge of lightfast Tubeway!

\$34.95 for the Apple II. At your computer store or:

TUBEWAY

 DATAMO

9748 Corycroft Ave., Chatsworth, CA 91311 709-1202

©1981
DATAMO

VISA MASTERCARD accepted. \$2.00 shipping handling charge. (California residents add 6% sales tax.)

*Apple II is a trademark of Apple Computer, Inc.

How to Make a Graphic-80 PET from a 4016

by James Strasma

A "Graphic 80" is an 80-column PET with the graphic-style keyboard. It can be made from a 4016 (Commodore's cheapest PET) by adding some inexpensive, readily available ICs and moving some jumpers. The author provides step-by-step instructions. In addition, instructions are provided to add extra keys to an 8032 or a Graphic 80.

The CBM 8032 offers an 80-column screen and a very business-oriented keyboard. Many PET owners would like to have the 80 columns, yet still maintain the easy access to graphic characters that the "graphic" keyboard offers. This does take some soldering and electronic assembly skill.

This article shows how to upgrade a "Fat Forty" 4016 or 4032 to a graphic keyboard, 80-column machine. There are several options available, including only upgrading to 32K, making a business-keyboard 8032, and adding extra keys to control video functions not previously accessible from a single key.

Before you begin, note that these changes are for ASSY. NO. 8032089, located on the right edge of the board, halfway back, the FCC-approved Universal Dynamic PET main board. Similar changes worked with earlier boards, as long as the computer came with the large, 12-inch screen.

Also note that procedures described below void any Commodore warranty, guarantees non-support by them, and cannot be guaranteed to work on your particular machine.

The traces on current PET computer boards are very tiny, and easily destroyed. Do not attempt this project unless you are skilled with a soldering iron. Before you start, unplug your machine for your safety and the computer's.

Install sockets where new chips are added. This makes the job easier and makes later repairs more convenient.

To make a 4032 from a 4016

□ Insert 4116 dynamic RAM chips in the vacant positions of column UA. These include UA4, UA6, UA8, UA10, UA12, UA14, UA16, and UA18, eight in all.

□ At the right front of the board, find the right end of jumper Y, and re-route that end to the next hole toward the rear, at the right end of a line labeled Z. (See figure 1.) Your PET will now display "31743 bytes free" when it is powered on. If it doesn't, check your connections.

To make an 80-column machine from a 4032

□ Move the right end of all ten jumpers at BA0 one hole to the rear. (See figure 2.)

□ Just behind jumpers Y and Z, move the right end of the jumper labeled both 3 and 40 one hole to the rear, the right end of the line marked 4 and 80. (See figure 1.)

□ Remove the short between pins 10 and 11 of UD2 from the bottom of the board, and repair those pins' connections on the top side of the board. If

you damage this chip, it can be inexpensively replaced. (UD2 is the chip in the upper-left of figure 1.)

□ Remove the jumpers at 6 and 7 between UB2 and UC3. (See figure 3.)

□ Add jumpers at 5 and at 8 in the same area (figure 3). The jumper at 8 should be between the most widely separated of its four holes.

□ Add 2114 static RAM chips at UC6 and UC7.

□ Add 74LS244 octal tri-state driver chips at UB6 and UB7.

□ Add a 74LS373 tri-state octal D flip-flop chip at UB8.

□ Replace the 2K ROM at UD7 with a suitable replacement, as described in the next section.

To make the result a business-keyboard 8032

□ Buy or program a ROM for UD7 identical to the one supplied in that position on the 8032. Commodore's part number is 901474-03. The correct EPROM substitute is a single 5-volt supply 2716.

□ Buy and install a business-keyboard in place of the graphic one

Figure 1: Detail of front of board showing positions of Jumpers Y, Z, 3, and 4, and IC UD2.

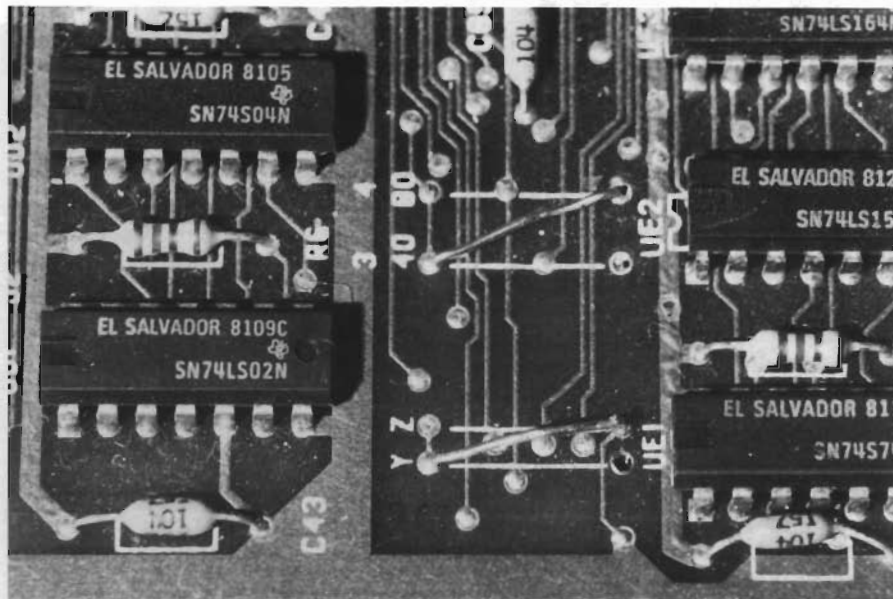

supplied. Since the cutouts will not match, the lower portion of the hood should be replaced, or you can make your own mounting plate.

To make the result a G80

□ Create a custom 2716 EPROM for UD7, or obtain one from a user group. The only change is to take the 80-byte keyboard look-up table from locations \$E798-\$E7E7 in the Fat Forty ROM, and copy it into the functionally equivalent location in the 8032's ROM, starting at \$E6D1. With this change, the G80 will lack only the REPEAT, ESCAPE, and TAB keys of the 8032.

However, as long as you have made the decision to modify the ROM, why not improve it? By changing only a few bytes, you may add not only the missing keys, but also up to four others.

Listing 1 shows my keyboard look-up table, which includes keys for TEXT/GRAPHICS, INSERT/DELETE LINE, ERASE TO BEGIN/END, and an optional value for SET TOP/BOTTOM OF SCREEN. The details are described later in the article.

Adjusting the Screen

There is a slight problem with the video adjustment that appears when CHR\$(14) is printed. The top and bottom lines disappear! To fix this, adjust the potentiometer labeled HEIGHT, from below the video display board, using a small non-conductive screwdriver. Bear in mind that parts of this board carry over 10,000 volts, even when the computer is unplugged!

Using the program below, adjust the pot so the test pattern just fills the screen:

```
10 PRINT CHR$(14)
20 FOR I = 1 TO 1999
30 : PRINT "#";
40 NEXT
50 GOTO 50
```

The same fix works on any Fat Forty.

To add missing and extra keys pull off the keyboard connector at the keyboard. Note that it has 18 separate connections. These correspond to the ten rows and eight columns of the keyboard matrix as shown in listing 1.

There is a small hole at each position in this connector. Using micro test clips available from Radio Shack, you can make temporary connections.

For a slightly more permanent attachment, I soldered tiny loops of wire to the keyboard side of the connector, as shown in figure 4. From the right edge of the keyboard connector, as viewed in place, the ten rows of the keyboard matrix are the first ten wires from the right. The eight columns of

Listing 1

:: E6D1	3D	2E	10	03	3C	20	5B	12
:: E6D9	2D	30	00	3E	19	5D	40	00
:: E6E1	2B	32	0E	3F	2C	4E	56	58
:: E6E9	33	31	0D	3B	4D	42	43	5A
:: E6F1	2A	35	1B	3A	4B	48	46	53
:: E6F9	36	34	15	4C	4A	47	44	41
:: E701	2F	38	16	50	49	59	52	57
:: E709	39	37	5E	4F	55	54	45	51
:: E711	14	11	09	29	5C	27	24	22
:: E719	1D	13	5F	28	26	25	23	21

Figure 2: Detail showing jumpers BA0 - BA10 and position of replacement EPROM at UD7.

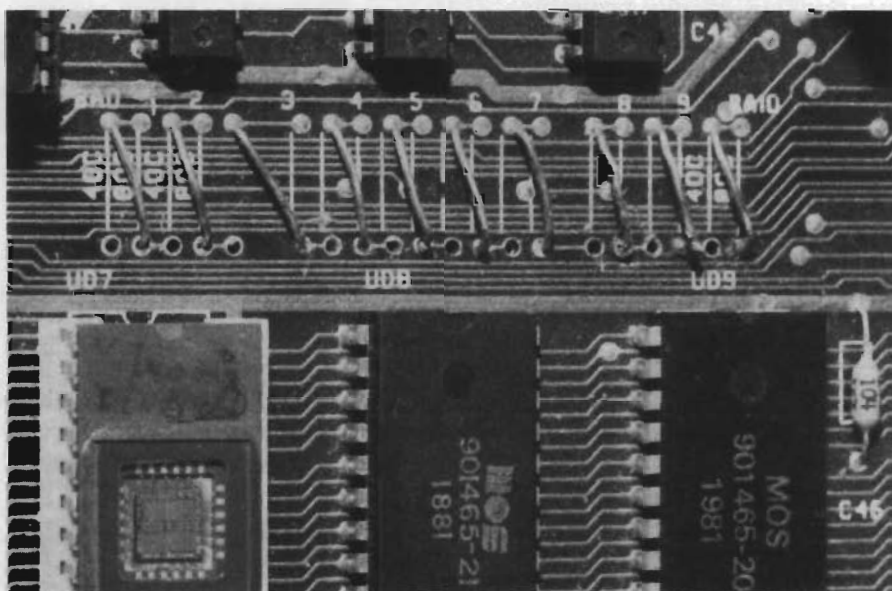
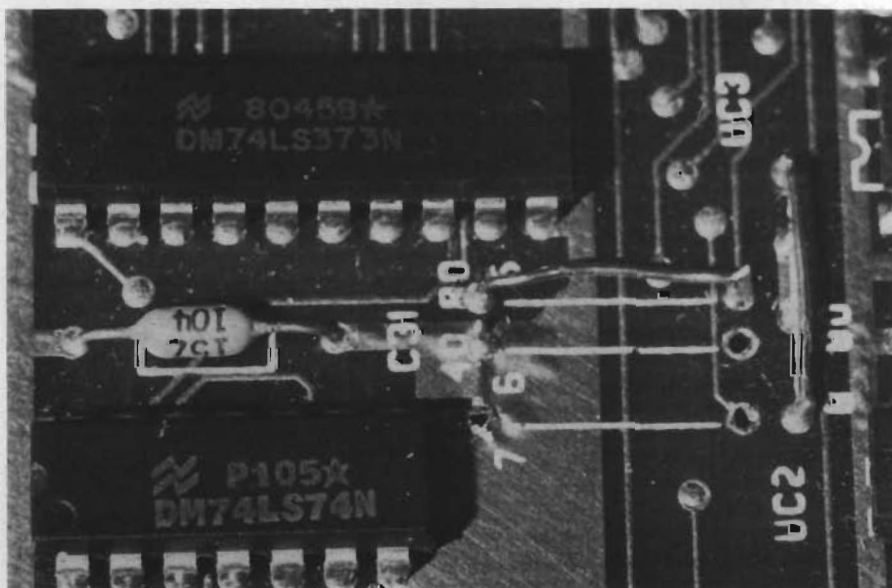

Figure 3: Detail showing jumpers 5, 6, 7, and 8.



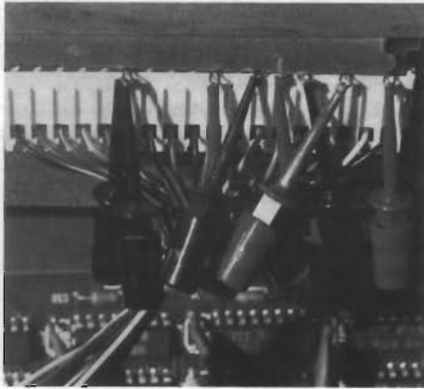

Figure 4: Added loops at keyboard connector and clip connections.

the matrix follow, again toward the left.

The six keys I have added are all in column 3 of listing 1. This corresponds to the thirteenth wire from the right. It is the one with two micro test clips in figure 4. Each of these wires connects to one pole of an added key (or push button, as I implemented it).

Rows 1, 3, 5, 6, 7, and 9 contain the added keys. Connect each one to the unused pole of the appropriate added "key." One more key could be added by attaching wires to row 2 and column 5. These correspond to positions 2 and 15 from the right end of the connector, and would be mated through another key.

If you prefer to implement another keyboard value, substitute your preferred PET ASCII value into the keyboard look-up table of listing 1. For instance, if you replace the \$03 at location \$E6D4 with \$07, then hitting the STOP key would ring the chime rather than halting running programs.

I chose to mount push buttons through the bezel surrounding the video screen, as shown in figure 5. I used Radio Shack's tiniest push buttons because they are unobtrusive, easier to push than large ones, and I couldn't find regular keyswitches. Regular keyswitches could be used, or a surplus keypad could be wired up.

The method for making the G80

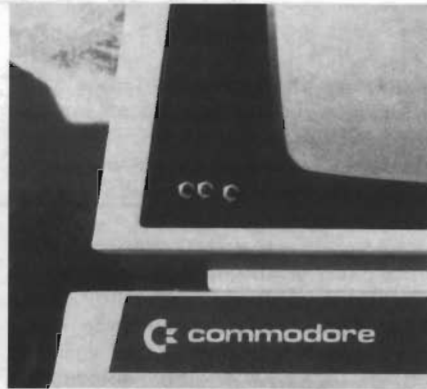

Figure 5: Micro push buttons added near screen. Three additional buttons were installed on the other side.

selectable between 40 and 80 columns requires three ICs to switch the necessary lines. This plan offers a simpler solution. It uses a 2732 EPROM, pre-programmed to mimic any two BASIC 4.0 ROM sets, and switches from one to the other by grounding one pin.

The disadvantage of this method is that the 40 columns appear smaller and centered on an 80-column screen, rather than occupying the full width, as on a Fat Forty.

For information on how to obtain this chip, see the box on this page.

Software Compatibility

Nearly everything for the 8032 also works on the G80, especially after adding the missing keys. This includes the 8096 memory expansion board, Silicon Office, COMAL, and VisiCalc 8096. The exceptions are complete languages, including UCSD Pascal, the former PET BASICs supplied with the 8096 board, and A.B. Computer's "Expanded BASIC" for the 8096. By modifying the programs, I have been able to get all but UCSD Pascal to work with the G80.

You may contact the author at 1280 Richland Ave., Lincoln, IL 62656.

MICRO

Obtaining Alternate ROMs

To order alternate ROMs for Commodore 8032 and G80 computers, write:

Jim Russo
Ann Arbor Terminals, Inc.
6175 Jackson Road
Ann Arbor, MI 48103

You may request any two of the following variations of BASIC 4:
Fat Forty (Current model, but centered on an 80-column screen.)
Skinny Forty (Also centered; works with far more games. No repeat function.)
Eighty (Same as the 8032.)

Be sure to specify whether the ROM is for a G80 or an 8032. I think the charge is still \$10 per ROM, barely above the cost of the 2732 itself.

ANDROID ATTACK

FOR  ATARI

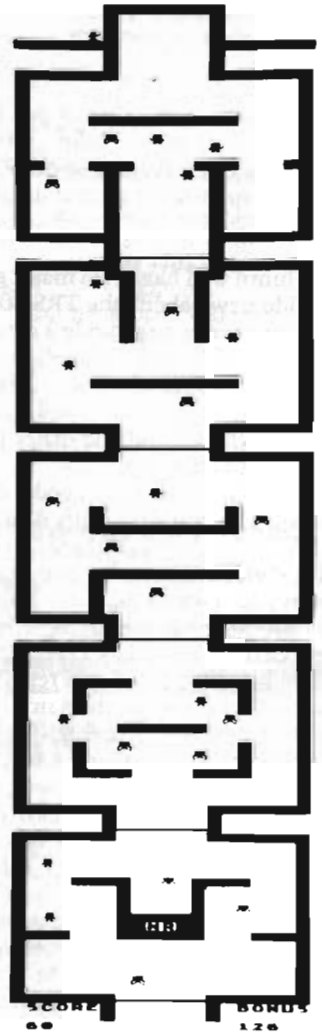

Fight your way down through the Top-Secret underground laboratory to save the runaway nuclear reactor, then try to save yourself before the Androids get you!

16K cassette, 32K disk (SPECIFY!)

Ask for ANDROID ATTACK at your local dealer or send \$18.95 + \$2.00 shipping. Write for our illustrated list of games for your ATARI.

PRETZELLAND SOFTWARE
2005 D WHITTAKER RD
YPSILANTI, MI 48197

MICRO™

CoCo Bits

By John Steiner

Ed. note: This is the first of our Color Computer columns. John will be augmenting our coverage of 6809 computers and helping to recruit authors.

This column will have two major goals: to provide news about the TRS-80 Color Computer, and to provide a clearinghouse for CoCo information. In addition, I hope to pass along any information on the 6809, the 6847 video display generator, and the other major components CoCo has.

Originally, it seems, Tandy developed CoCo to compete with Atari, the VIC 20, and other game machines of similar style. Witness the use of ROM program packs for games, etc. This emphasis seems to be changing slightly. Just recently, Tandy has taken the 4K machine off the market and replaced it with a 16K version, at the same price. With the addition of the 32K upgrade (which uses 64K chips), CoCo has entered a new world. The newer, more powerful machine has been easily converted to 64K and given the capacity to run FLEX. OS-9 will probably be available by the time you read this. These two powerful operating systems allow a vast range of 6809 software to be executed from CoCo. As I learn more details of these CoCo expansions, I will pass them along.

Since this is the games issue, I have some game-oriented information this month. If you have a Color Computer disk system, you have no doubt been frustrated by the fact that the CoCo DOS scratchpad is located at \$600, just where many machine-language tape programs like to reside. I am grateful that Tandy has started releasing some software on tape since disk users have trouble getting the disk drive and a ROM pack in the ROMport at the same time. It is a shame, though, to have to spend several minutes loading a 14K adventure game from tape, when that expensive disk system just sits there taking up space.

I purchased "BEDLAM," an adventure game on tape, and decided I would have to transfer it to disk. Being a

relative beginner to machine-language programming and only having experience with the 6800, I have been waiting for Tandy's assembler (though others became available, I had a deposit on Tandy's). When it finally arrived, I plugged in the EDTASM+ ROM pack (doggone it, there went the disk again), and loaded BEDLAM using an offset of 16384. Using the monitor, I found the start and end addresses, and tacked a little routine at the end. This routine, shown below, moves the program, one byte at a time (I forgot about the D register) down to \$600. It then transfers execution to \$600, the start address of BEDLAM.

You may enter and assemble the listing yourself, or enter the object code from the assembler listing using a monitor. Once the routine is in place, beginning at \$7F02, use CLOADM "BEDLAM",16384 to load in BEDLAM. Transfer the whole thing to disk with the command SAVEM "BEDLAM", &H4600, &H7F15, &H7F02. Notice the execute address is the start address of the memory move routine. To run the program, you can just use LOADM "BEDLAM": EXEC, or you can write a BASIC load routine, and let BASIC do the work for you with a simple RUN "BEDLAM".

Once the program has been loaded into the region at \$600, disk BASIC is essentially gone. The quick and dirty method to restore DOS is to shut the computer off, then turn it on again. A better way is to let RESET do it for you.

CoCo BASIC has two options in its reset routine: a cold start and a warm start. When RESET is pressed, memory location 113 is checked for \$55. If found, a warm start is done, any program in memory is saved, string memory, number of graphics pages reserved, and other parameters are kept. If, on the other hand, anything but \$55 appears, BASIC assumes a cold start and reconfigures the system to power up status. This little trick will recover our disk when we are through with BEDLAM. Before loading the program, from BASIC enter POKE 113,0. Alternatively, you could add a routine at the beginning of the machine-language loader that will store a zero into location 113 before executing BEDLAM. When you are ready to quit BEDLAM, just press RESET. DOS will be reconnected. You will not be missing any fancy end routine by leaving BEDLAM in this manner.

A quirk of this and the other Radio Shack adventure games I've seen is their STOP or QUIT command. I would have expected control to return to BASIC. What happens is that the keyboard will lock up, causing you to turn off the computer or press RESET to regain control. As long as you have to press RESET anyway, you might as well reconnect the disk. Though not particularly fast or fancy, you can use the routine on any 32K machine to transfer programs. Just substitute the correct start, end, and execute addresses where required.

```

*
*          ORG   $7F02
*PROGRAM TO MOVE BEDLAM*
*JOHN STEINER 8/1/82*
7F02 8E    4600  START  LDX   #$4600    Load current start address
7F05 108E  0600          LDY   #$600    Load new start address
7F09 A6    80          MOVE  LDA   ,X+     Load byte from current address
7F0B A7    A0          STA   ,Y+     Store byte to new address
7F0D 8C    7F01        CMPX  #$7F01   Done yet?
7F10 26    F7          BNE   MOVE   If not go do it again
7F12 BD    0600        JSR   $600
END

```

One more programming hint for this month. Disk users are told by the disk system manual that "COPY" is available for only multi-drive users. This is incorrect. If you have a single disk drive, you can enter COPY "filename/ext". You will be prompted as to when to switch disks. In addition, unlike BACKUP and DSKINI, COPY is non-destructive of the program in memory. If you have a long program in memory and a large file to copy, however, you may have to switch disks a couple of times. COPY can be used to transfer any file type, and easily transfers machine-language or data files. I will have more details on COPY next month, including a small routine that assists in selective disk backups.

I am an electronics instructor by profession, and would like to make a couple of comments on CoCo in school. Tandy is developing courseware that runs on the Color Computer. CoCo will be making appearances in classrooms around the country if Tandy has anything to say about it. By the time you read this, teachers will have access to programs such as Chemistry Simulations. Radio Shack's Talk/Tutor

development system is the medium for several recently released educational packages, including Vocabulary Tutor I, and Inventions That Changed Our Lives. Talk/Tutor programs make good use of the high-resolution graphics and audio features of CoCo.

In addition to these and other educational software, Color PILOT will have been released. PILOT has been used by many instructors who wanted to develop computer-assisted instruction, yet did not want to learn the complexities of BASIC. Color LOGO, another popular language with educators, should also be available. Both programs will have disk versions; LOGO will also be on ROM pack.

I am looking forward to comments from readers. I plan on including programming hints, and CoCo- and 6809-related news. In addition, CoCo disk users are probably a distinct minority and I will have information on Color BASIC and Extended BASIC, as well as disk BASIC. I can be reached at 508 Fourth Ave. NW, Riverside, ND 58078, or contact me through MICRO.

MICRO™

AT LAST... ...FOR OS!

For investors
and financial managers
Stock portfolio analysis
\$150.00

- in your office - instant valuations
- compound growth measurement
- pertinent company operating statistics

**Stock financial
statement analysis**
\$250.00

- input your interpretation
of financial data
- analyze up to 10 years of data
- see mean, trend and stability

On-line data retrieval
\$50.00

Accounting package
\$150.00

DBM system
\$200.00

for 8" floppy/hard disc
under OS65U

**NEW! Full Screen Editor
for Polled Keyboard**
\$75.00

- for OS65D & OS65U
- machine language based
- type or cursor mode

write for details

**Genesis Information
Systems, Inc.**

P.O. Box 3001 • Duluth, MN • 55803
Phone 218/724-3944

PERRY PERIPHERALS REPAIRS KIMs!! (SYMs AND AIMs TOO)

- We will Diagnose, Repair, and Completely Test your Single Board Computer
- We Socket all replaced Integrated Circuits
- You receive a 30-day Parts and Labor Warranty
- Your repaired S.B.C. returned via U.P.S. — C.O.D., Cash

Don't delay! Send us your S.B.C. for repair today
Ship To: (Preferably via U.P.S.)

PERRY PERIPHERALS
6 Brookhaven Drive
Rocky Point, NY 11778

KIM-1 REPLACEMENT MODULES

- Exact replacement for MOS/Commodore KIM-1 S.B.C.
- Original KIM-1 firmware — 1K and 4K RAM versions

REPLACEMENT KIM-1 KEYBOARDS

- Identical to those on early KIMS — SST switch in top right corner
- Easily installed in later model KIMS

Perry Peripherals is an authorized HDE factory service center.

Perry Peripherals carries a full line of the acclaimed HDE expansion components for you KIM, SYM, and AIM, including RAM boards, Disk Systems, and Software like HDE Disk BASIC V1.1. Yes, we also have diskettes. For more information write to: P.O. Box 924, Miller Place, NY 11764, or Phone (516) 744-6462.



BOX 120
ALLAMUCHY, N.J. 07820
201-362-6574

HUDSON DIGITAL ELECTRONICS INC.

THE TASK* MASTERS

HDE supports the *TIM, AIM, SYM and KIM (TASK) with a growing line of computer programs and peripheral components. All HDE component boards are state-of-the-art 4½" x 6½", with on board regulation of all required voltages, fully compatible with the KIM-4 bus.

OMNIDISK 65/8 and 65/5

Single and dual drive 8" and 5¼" disk systems. Complete, ready to plug in, bootstrap and run. Include HDE's proprietary operating system, FODS (File Oriented Disk System).

DM816-M8A

An 8K static RAM board tested for a minimum of 100 hours and warranted for a full 6 months.

DM816-UB1

A prototyping card with on-board 5V regulator and address selection. You add the application.

DM816-P8

A 4/8K EPROM card for 2708 or 2716 circuits. On board regulation of all required voltages. Supplied without EPROMS.

DM816-CC15

A 15 position motherboard mounted in a 19" RETMA standard card cage, with power supply. KIM, AIM and SYM versions.

DISK PROGRAM LIBRARY

Offers exchange of user contributed routines and programs for HDE Disk Systems. Contact Progressive Computer Software, Inc. for details.

HDE DISK BASIC

A full range disk BASIC for KIM based systems. Includes PRINT USING, IF ... THEN ... ELSE. Sequential and random file access and much more. \$175.00

HDE ADVANCED INTERACTIVE DISASSEMBLER (AID)

Two pass disassembler assigns labels and constructs source files for any object program. Saves multiple files to disk. TIM, AIM, SYM, KIM versions. \$95.00

HDE ASSEMBLER

Advanced, two pass assembler with standard mnemonics. KIM, TIM, SYM and KIM cassette versions. \$75.00 (\$80.00 cassette)

HDE TEXT OUTPUT PROCESSING SYSTEM (TOPS)

A comprehensive text processor with over 30 commands to format and output letters, documents, manuscripts. KIM, TIM and KIM cassette versions. \$135.00 (\$142.50 cassette)

HDE DYNAMIC DEBUGGING TOOL (DDT)

Built in assembler/disassembler with program controlled single step and dynamic breakpoint entry/deletion. TIM, AIM, SYM, KIM AND KIM cassette versions. \$65.00 (\$68.50 cassette)

HDE COMPREHENSIVE MEMORY TEST (CMT)

Eight separate diagnostic routines for both static and dynamic memory. TIM, AIM, SYM, KIM and KIM cassette versions. \$65.00 (\$68.50 cassette)

AVAILABLE DIRECT OR FROM THESE FINE DEALERS:

Progressive Computer Software
405 Corbin Road
York, PA 17403
(717) 845-4954

Johnson computers
Box 523
Medina, Ohio 44256
(216) 725-4560

Falk-Baker Associates
382 Franklin Avenue
Nutley, NJ 07110
(201) 661-2430

Perry Peripherals
P.O. Box 924
Miller Place, NY 11764
(516) 744-6462

Lux Associates
20 Sunland Drive
Chico, CA 95926
(916) 343-5033

Laboratory Microcomputer Consultants
P.O. Box 84
East Amherst, NY 14051
(716) 689-7344

Castle Adventure for PET and Apple

by David Malmberg

Castle Adventure is a role-playing game that involves traveling throughout a dangerous castle in search of treasure. The goal is to rescue the princess, while avoiding the many dangers about you.

Castle Adventure requires:

**PET/CBM with 32K
or Apple II with 48K
or other Microsoft BASIC
computer**

In CASTLE ADVENTURE you play the role of Godfrey de Goodheart, a bold, but impoverished knight. King Fredrick III has dispatched you to rescue his only daughter, the beautiful Princess Fatima, from the dungeons of Baron von Evil's castle. You have also been asked to capture the Baron's treasures of gold, silver, and gems, which he amassed by cruelly exploiting his serfs. If you can rescue the princess and return with all of the Baron's ill-gotten treasures, King Fredrick has promised you Princess Fatima's hand in marriage.

Your quest will be filled with peril. The seven lone knights who were previously sent on this crusade all vanished without a trace. If you are to succeed where so many others have failed, you must use all your strength and cunning — and be very lucky!

During your quest the computer will be your guide. You take action by giving the computer a series of one- or two-word commands, such as: GO SOUTH (or just "S"), OPEN DOOR, GET KEYS, LEAVE CHEST, SWIM. The computer has a vocabulary of only about 100 words. If it does not understand your command, try something else. A complete list of this vocabulary

is purposely not included. At least half the fun will be establishing the computer's lexicon. Several commands will be particularly useful:

- INVENTORY (or just "I") will give you a list of all the items you are carrying.
- LOOK (or just "L") may reveal significant details that may help you in your quest.
- HELP (or just "H") may result in a valuable hint.
- SAVE will cause the current status of the game to be saved on tape or disk.
- LOAD will enable you to resume a previously saved game.
- SCORE will show you the total number of points you have earned so far.
- QUIT will end the game and show you your final score.

Remember that everything you encounter in your adventure has a purpose. There are plenty of clues, but it will take imagination, perseverance, cunning, skill, and most of all luck to win the Princess's hand.

Converting to Other Computers

CASTLE ADVENTURE, as shown in listing 1, is written for a 32K PET/CBM computer. Listing 2 shows changes required for an Apple II. However, the program is written in "standard" Microsoft BASIC, so conversion to other Microsoft machines should be a relatively trivial task. There are only three areas where changes to the program will have to be made.

First, you will have to replace the screen and cursor control commands of the PET. These are shown in the listing within square brackets in their "English equivalents" so their meaning should be fairly obvious; i.e., CLR means clear the screen, 3 DOWN means move the cursor down three rows, etc. CASTLE ADVENTURE is written for a 40-column screen, so no spacing changes will be required for the

Atari (with Microsoft BASIC) or other 40-column systems.

The second change is to convert the LOAD game (lines 24 to 36) and SAVE game (lines 219 to 233) routines so they will be compatible with your machine's tape and/or disk command formats. The variables you want to SAVE and LOAD are: SF, LX, DF, R, and the array IA[.], which has IL elements (including a zero-th element).

The last thing to change is the reference to the PET ROMs in line 390.

Acknowledgement

Many of the ideas in CASTLE ADVENTURE, as well as other adventures that are widely available, owe a tremendous debt to Scott Adams. In the specific case of CASTLE, it uses a database structure and table-driven logic similar to those first described by Adams in several articles. These articles are a *must* for the true adventureophile:

1. "An Adventure in Small Computer Game Simulation," *Creative Computing*, (August 1979). Describes the data-base structure.
2. "Adventureland," *Softside*, (July 1980). Describes the table-driven logic.
3. "Pirate's Adventure," *BYTE*, (December 1980). Also describes the table-driven logic.

Castle Adventure listing begins on page 42. The changes for Apple II (listing 2) are on page 46.

David Malmberg is the author or co-author of several personal computer packages; the most recent is *VIC Turtle Graphics* published by Human Engineered Software. You may contact him at 43064 Via Moraga, Fremont, CA 94539.

Listing 1: Castle Adventure for PET/CBM

```

1 PRINT "[CLR][ 4 DOWN] WELCOME TO CASTLE ADVENTURE"
2 PRINT "[DOWN] BY DAVID MALMBERG"
3 PRINT "[ 3 DOWN] BASED ON THE IDEAS, DATA STRUCTURE"
4 PRINT "[ 3 DOWN] AND DRIVER PROGRAM OF SCOTT ADAMS"
5 PRINT "[ 3 DOWN]READING DATA TABLES -- JUST A MOMENT"
6 REM DATA STRUCTURE EXPLAINED IN CREATIVE COMPUTING AUGUST 1979
7 REM TRS-80 VERSION OF DRIVER PROGRAM GIVEN IN BYTE DECEMBER 1980
8 REM AND IN SOFTSIDE JULY 1980
9 GOSUB 235:TD=0:TD=0
10 FOR X=1 TO NL:IF NV$(X,0)="GET" THEN TD=X
11 IF NV$(X,0)="DR" THEN TD=X
12 NEXT X
13 DIM L$(NL),U$(NL)
14 FOR X=0 TO NL:L$(X)=CL:U$(X)=0:NEXT X
15 FOR X=0 TO CL:U=INT(C0$(X)/150)
16 IF X>U$(X)THEN U$(X)=X
17 IF X<L$(X)THEN L$(X)=X
18 NEXT X
19 FOR X=0 TO NL:IF L$(X)=CL AND U$(X)=0 THEN U$(X)=CL
20 NEXT X
21 PRINT "[CLR]"
22 R=AR:LX=L:DF=0:SF=0:INPUT "USE SAVED GAME (Y OR N) [ 3 LEFT]";K
$
23 IF LEFT$(K$,1)<>"Y" THEN PRINT "[CLR]";GOTO 37
24 INPUT "[CLR][RUS][OFF]RAPE OR [RUS][OFF]ISK O[ 3 LEFT]";K$
25 IF K$<"T" AND K$<"O" THEN 24
26 IF K$="T" THEN 32
27 INPUT "DRIVE [RUS][OFF] OR [RUS][OFF] 0[ 3 LEFT]";K$
28 IF K$<"0" AND K$<"1" THEN 27
29 DN$=CHR$(34)+K$+":
30 INPUT "[DOWN]TITLE [ 3 LEFT]";LT$:IF LT$="*" THEN 30
31 OPEN 1,0,0,0,DN$+LT$+".S,R":GOTO 34
32 INPUT "IS SAVED GAME TAPE POSITIONED";K$:IF LEFT$(K$,1)<>"Y" THEN 2
2
33 OPEN 1,1,0,"ADVENTURE GAME"
34 INPUT#1,SF,LX,DF,R
35 FOR X=0 TO IL:INPUT#1,IR(X):NEXT X
36 CLOSE 1
37 GOSUB 66:GOTO 44
38 PRINT:INPUT "WHAT DO YOU WANT TO DO [ 3 LEFT]";TP$:PRINT:GOSUB 45
39 IF F THEN PRINT "YOU USE WORD(S) I DON'T KNOW!";GOTO 38
40 GOSUB 82:IF IR(?)=-1 THEN LX=LX-1:GOTO 42
41 GOTO 44
42 IF LX<0 THEN PRINT "LIGHT HAS RUN OUT!";IR(?)=0:GOTO 44
43 IF LX<25 THEN PRINT "LIGHT RUNS OUT IN";LX;"TURNS!"
44 NV(0)=0:GOSUB 82:GOTO 38
45 IF LEN(TP$)>1 THEN 55
46 IF TP$="U" THEN TP$="GO UP";GOTO 55
47 IF TP$="D" THEN TP$="GO DOWN";GOTO 55
48 IF TP$="E" THEN TP$="GO EAST";GOTO 55
49 IF TP$="W" THEN TP$="GO WEST";GOTO 55
50 IF TP$="N" THEN TP$="GO NORTH";GOTO 55
51 IF TP$="S" THEN TP$="GO SOUTH";GOTO 55
52 IF TP$="I" THEN TP$="INVENTORY";GOTO 55
53 IF TP$="L" THEN TP$="LOOK";GOTO 55
54 IF TP$="H" THEN TP$="HELP"

```

Listing 1 (continued)

```

55 K=0:NT$(0)="":NT$(1)="":AR=0
56 FOR X=1 TO LEN(TP$):K$=MID$(TP$,X,1):IF K$=" " THEN K=1:GOTO 58
57 NT$(K)=LEFT$(NT$(K)+K$,LN)
58 NEXT X:FOR X=0 TO 1:NV(X)=0:IF NT$(X)=" " THEN 64
59 FOR Y=0 TO NL:K$=NV$(Y,X):IF LEFT$(K$,1)="*" THEN K$=MID$(K$,2)
60 IF X=1 AND Y<7 THEN K$=LEFT$(K$,LN)
61 IF NT$(X)=K$ THEN NV(X)=Y:GOTO 63
62 NEXT Y:GOTO 64
63 IF LEFT$(NV$(NV(X),X),1)="*" THEN NV(X)=NV(X)-1:GOTO 63
64 NEXT X:IF NV(0)=TQ OR NV(0)=TD AND NV(1)<1 THEN AR=1:F=0:RETURN
65 F=NV(0)<1 OR LEN(NT$(1))>0 AND NV(1)<1:RETURN
66 IF DF THEN IF IR(?)<-1 AND IR(?)<R THEN PRINT "IT IS TOO DARK TO
SEE!";RETURN
67 K=-1:IF LEFT$(RS$(R),1)="*" THEN PRINT MID$(RS$(R),2):;GOTO 69
68 PRINT "YOU ARE IN ";RS$(R);
69 FOR Z=0 TO IL:IF K THEN IF IR(Z)=R THEN PRINT:PRINT "[DOWN]VISIBLE
ITEMS HERE:";K=0
70 GOTO 75
71 TP$=IR$(Z):IF RIGHT$(TP$,1)<>"/" THEN RETURN
72 FOR W=LEN(TP$)-1 TO 1 STEP-1:IF MID$(TP$,W,1)="/" THEN TP$=LEFT$(TP
$,W-1):RETURN
73 NEXT W
74 RETURN
75 IF IR(Z)<R THEN 78
76 GOSUB 71:IF POS(0)+LEN(TP$)+3>39 THEN PRINT
77 PRINT TP$;" "
78 NEXT:PRINT
79 K=-1:FOR Z=0 TO 5:IF K THEN IF AR(R,Z)<>0 THEN PRINT:PRINT "OBVIOUS
EXITS: ";K=0
80 IF AR(R,Z)<>0 THEN PRINT NV$(Z+1,1);" ";
81 NEXT:PRINT:PRINT:RETURN
82 FZ=-1:F=-1:F3=0:IF NV(0)=1 AND NV(1)<7 THEN 134
83 LZ=LN(NV(0)):U2=U1%(NV(0))
84 IF NV(0)<>0 THEN 89
85 V=INT(RND(1)*100+1)
86 FOR X=L2 TO U2
87 IF V<C0%(X)THEN 95
88 NEXT X:RETURN
89 IF AR=1 THEN GOSUB 199:RETURN
90 N=NV(1)+150#NV(0):V=150#NV(0):F4=0
91 IF NV(0)=TQ OR NV(0)=TD THEN FZ=0
92 FOR X=L2 TO U2
93 IF N=C0%(X)OR V=C0%(X)THEN 95
94 NEXT X:GOTO 179
95 F4=1:FZ=-1:F=0:F3=-1:FOR Y=1 TO 5:ON Y GOTO 96,97,98,99,100
96 N=C1%(X):GOTO 101
97 N=C2%(X):GOTO 101
98 N=C3%(X):GOTO 101
99 N=C4%(X):GOTO 101
100 N=C5%(X):GOTO 101
101 LL=INT(W/20):K=M-L*20:F1=-1
102 ON K+1 GOTO 121,109,111,113,115,116,117,118,119,120,105,107
103 IF K<12 THEN 105
104 ON K-11 GOTO 110,112,114
105 F1=-1:FOR Z=0 TO IL:IF IR(Z)=-1 THEN 121
106 NEXT:F1=0:GOTO 121

```

Listing 1 (continued)

```

161 FOR X=0 TO IL:IA(X)=I2(X):NEXT:PRINT "[CLR]":GOTO 22
162 GOSUB 63:GOTO 176
163 L=0:FOR Z=1 TO IL:IF IA(Z)=TR THEN IF LEFT$(IA$(Z),1)="*" THEN L=L+1
164 NEXT Z:PRINT "YOU'VE STORED";L;"TREASURES. ON A SCALE"
165 PRINT "OF 0 TO 100 THAT RATES A";INT(L/TT*100)
166 IF L=TT THEN PRINT "WELL DONE. ";GOTO 160
167 GOTO 176
168 PRINT "YOU HAVE:";K$;"NOTHING":FOR Z=0 TO IL:IF IA(Z)<>-1 THEN 171
169 GOSUB 71:IF LEN(TP$)+POS(0)>39 THEN PRINT
170 PRINT TP$;"."/;K$=""
171 NEXT:PRINT K$:GOTO 176
172 P=0:GOTO 155
173 P=0:GOTO 157
174 LX=LT:IA(0)=1:GOTO 176
175 PRINT "[CLR]"
176 NEXT Y
177 IF NU(0)<>0 THEN 179
178 NEXT X
179 IF NU(0)=0 THEN 187
180 IF NU(0)<>TQ AND NU(0)<>TD AND F4=0 THEN PRINT "I DON'T UNDERSTAND
YOUR COMMAND"
181 IF F2 THEN 187
182 IF NU(0)<>TQ AND NU(0)<>TD AND NOT F2 THEN PRINT "NOTHING HAPPENED"
:RETURN
183 IF NU(0)=TQ THEN GOSUB 197
184 IF NU(0)=TD THEN GOSUB 197
185 IF F=0 THEN 187
186 IF NOT F2 THEN PRINT "YOU CAN'T DO THAT YET."
187 RETURN
188 IP=IP+1
189 ON IP GOTO 190,191,192,193,194
190 M=C12(X):GOTO 195
191 M=C22(X):GOTO 195
192 M=C32(X):GOTO 195
193 M=C42(X):GOTO 195
194 M=C52(X):GOTO 195
195 P=INT(M/20):M=M-P*20:IF M<>0 THEN 188
196 RETURN
197 IF NU(0)=0 THEN 218
198 IF NU(1)=0 THEN PRINT "WHAT?":GOTO 211
199 IF NU(0)<>TQ THEN 202
200 L=0:FOR Z=0 TO IL:IF IA(Z)=-1 THEN L=L+1
201 NEXT:IF L)=MX THEN PRINT "YOU'VE TOO MUCH ALREADY!":GOTO 211
202 K=0:FOR X=0 TO IL:IF RIGHT$(IA$(X),1)<>"/" THEN 212
203 LL=LEN(IA$(X))-3:TP$=MID$(IA$(X),1)<>"/" THEN 212
204 IF TP$<>INT$(1) THEN 212
205 IF NU(0)=TQ THEN 208
206 IF IA(X)<>-1 THEN K=1:GOTO 212
207 IA(X)=R:K=3:GOTO 210
208 IF IA(X)<>R THEN K=2:GOTO 212
209 IA(X)=-1:K=3
210 PRINT "OK":PRINT
211 F=0:RETURN
212 NEXT X
213 IF K=1 THEN PRINT "YOU DO NOT HAVE IT!"
214 IF K=2 THEN PRINT "I DON'T SEE IT HERE."

```

Listing 1 (continued)

```

107 F1=0:FOR Z=0 TO IL:IF IA(Z)=-1 THEN 121
108 NEXT:F1=-1:GOTO 121
109 F1=IA(LL)<>-1:GOTO 121
110 F1=IA(LL)<>-1 AND IA(LL)<>R:GOTO 121
111 F1=IA(LL)=R:GOTO 121
112 F1=IA(LL)<>0:GOTO 121
113 F1=IA(LL)=R OR IA(LL)=-1:GOTO 121
114 F1=IA(LL)=0:GOTO 121
115 F1=R:GOTO 121
116 F1=IA(LL)<>R:GOTO 121
117 F1=IA(LL)<>-1:GOTO 121
118 F1=R:GOTO 121
119 F1=SF AND INT(2*LL+.5):IF F1<>0:GOTO 121
120 F1=SF AND INT(2*LL+.5):IF F1=0
121 F2=SF2 AND F1:IF F2 THEN NEXT Y:GOTO 123
122 NEXT X:GOTO 179
123 IP=0:FOR Y=1 TO 4:K=INT((Y-1)/2)+6:ON Y GOTO 124,125,126,127
124 AC=INT(C6*(X)/150):GOTO 128
125 AC=C6*(X)-INT(C6*(X)/150)*150:GOTO 128
126 AC=INT(C7*(X)/150):GOTO 128
127 AC=C7*(X)-INT(C7*(X)/150)*150
128 IF AC>101 THEN 133
129 IF AC=0 THEN 176
130 ON AC<52 THEN PRINT M$(AC):GOTO 176
131 ON AC<51 GOTO 144,148,149,151,152,153,154,151,156,158,159
132 ON AC<52 GOTO 140,162,163,148,172,173,174,175,219,150
133 PRINT M$(AC-50):GOTO 176
134 L=DF:IF L THEN L=DF AND IA(0)<>R AND IA(0)<>-1:GOTO 136
135 GOTO 137
136 IF L THEN PRINT "DANGEROUS IN THE DARK!"
137 IF NU(1)<1 THEN PRINT "GIVE ME A DIRECTION TOO.":GOTO 187
138 M=R:R=NU(1)-1
139 IF K=1 THEN 142
140 IF L THEN PRINT "YOU FELL DOWN AND BROKE YOUR NECK.":K=R:L:DF=0:GOTO
142
141 PRINT "YOU CAN'T GO IN THAT DIRECTION!":GOTO 187
142 IF NOT L THEN PRINT "[CLR]"
143 R=K:GOSUB 66:GOTO 187
144 L=0:FOR Z=1 TO IL:IF IA(Z)=-1 THEN L=L+1
145 NEXT Z
146 IF L)=MX THEN PRINT "YOU'VE TOO MUCH ALREADY!":GOTO 177
147 GOSUB 188:IA(P)=1:GOTO 176
148 GOSUB 188:IA(P)=R:GOTO 176
149 GOSUB 188:R=P:GOTO 176
150 GOSUB 188:L=P:GOSUB 188:Z=IA(P):IA(P)=IA(L):IA(L)=Z:GOTO 176
151 GOSUB 188:IA(P)=0:GOTO 176
152 DF=-1:GOTO 176
153 DF=0:GOTO 176
154 GOSUB 188
155 SF=INT(.5+2*P)OR SF:GOTO 176
156 GOSUB 188
157 SF=SF AND NOT INT(.5+2*P):GOTO 176
158 PRINT "YOU'RE DEAD...":R=L:DF=0:GOTO 162
159 GOSUB 188:IL=P:GOSUB 188:IA(L)=P:GOTO 176
160 INPUT "THIS GAME IS NOW OVER. ANOTHER GAME?";K$:IF LEFT$(K$,1)="N"
THEN END

```

Listing 1 (continued)

```

215 IF K=0 AND NU(1)=0 THEN PRINT "IT'S BEYOND YOUR POWER TO DO THAT.":
F=0
216 IF K=0 AND NU(1)<>0 THEN F=1
217 IF K<>0 THEN F=0
218 RETURN
219 PRINT "ICLR":
220 INPUT "CRUIT[OFF]JAPE OR [RUS][OFF]ISK [C 3 LEFT]":K$
221 IF K$="T" AND K$="D" THEN 220
222 IF K$="I" THEN 223
223 INPUT "DRIVE [RUS][OFF] OR [RUS][OFF] [C 3 LEFT]":K$
224 IF K$="0" AND K$="1" THEN 223
225 DN$=CHR$(34)+K$+":":
226 INPUT "DONUT[TITLE #] [C 3 LEFT]":LT$:IF LT$="*" THEN 226
227 OPEN "1-0.1.DN$+LT$+"$.M" GO TO 230
228 INPUT "OUTPUT TAPE READY TO SAVE GAME":K$:IF LEFT$(K$,1)<>"Y" THEN
229
229 OPEN "1.1.1.ADVENTURE GAME"
230 C$=CHR$(13):PRINT#1,5F:JC$=LX:O$=DF:IC$=R:IC$
231 FOR W=0 TO IL:PRINT#1,IA(W):C$
232 POKE 59411,53:FOR Z=1 TO 10:NEXT Z:POKE 59411,61
233 NEXT W:CLOSE 1
234 GOTO 175
235 READ TL$
236 READ IL,CL,NL,RL,MX,AR,TT,LN,LT,ML,TR
237 CG=CL+3:NN=NL+12
238 DIM NU(1),CO$(CO),C1$(CC),C2$(CC),C3$(CC),C4$(CC),C5$(CC),C6$(CC),C7$(CC),
7$(CC)
239 DIM NU$(NN,1),IA$(IL),IA$(IL),R$(RL),RM$(RL,5),M$(ML),NT$(1),I2(IL)
240 FOR X=0 TO CL STEP 2:V=X+1
241 READ CO$(X),C1$(X),C2$(X),C3$(X),C4$(X),C5$(X),C6$(X),C7$(X)
242 READ CO$(Y),C1$(Y),C2$(Y),C3$(Y),C4$(Y),C5$(Y),C6$(Y),C7$(Y)
243 NEXT X
244 FOR X=0 TO NL STEP 5
245 READ NU$(X+0,0),NU$(X+0,1)
246 READ NU$(X+1,0),NU$(X+1,1)
247 READ NU$(X+2,0),NU$(X+2,1)
248 READ NU$(X+3,0),NU$(X+3,1)
249 READ NU$(X+4,0),NU$(X+4,1)
250 NEXT X
251 FOR X=0 TO RL:READ RM$(X,0),RM$(X,1),RM$(X,2),RM$(X,3),RM$(X,4),RM$(X,5),
R$(X)
252 NEXT X
253 FOR X=0 TO ML:READ M$(X),NEXT X
254 FOR X=0 TO IL:READ IA$(X),IA$(X):I2(X)=IA(X)
255 NEXT X:M$(9)=M$(6)+1 WITH YOUR HEAD! RETURN
256 DATA CRISTE,65,171,55,42,5,1,11,3,100,7,3,12
257 DATA 5,261,280,0,0,0,6555,0,5,883,0,0,0,0,10076,0
258 DATA 20,883,564,0,0,0,15109,16200,25,494,265,260,0,0,7983,0
259 DATA 25,344,265,260,0,0,7983,0,40,792,1032,0,0,0,10613,9150
260 DATA 40,224,262,280,20,200,6352,8754,50,784,265,1165,260,0,7983,0
261 DATA 50,584,905,900,0,0,10501,5761,100,264,134,120,140,0,10800,0
262 DATA 50,264,322,0,0,0,10501,5761,100,264,134,120,140,0,10800,0
263 DATA 100,124,0,0,0,0,8550,0,100,264,121,120,140,0,10800,0
264 DATA 100,883,324,0,0,0,16162,0,100,23,660,200,20,0,9364,9960
265 DATA 100,564,0,0,0,0,9813,0,100,264,181,160,40,0,10800,0
266 DATA 100,883,624,0,0,0,16159,0,100,883,504,0,0,0,16160,0

```

Listing 1 (continued)

```

267 DATA 100,262,561,260,220,0,6612,0,150,261,0,0,0,0,1243,0
268 DATA 161,224,722,620,0,0,8170,9600,161,824,1222,720,0,0,0,8170,9600
269 DATA 161,1062,800,0,0,0,8170,9600,168,682,440,0,0,0,8170,9600
270 DATA 170,44,60,0,0,0,8170,9600,170,24,60,0,0,0,8170,9600
271 DATA 171,104,240,0,0,0,8170,9600,172,104,120,0,0,0,8170,9600
272 DATA 172,124,140,0,0,0,8454,10564,173,284,260,0,0,0,8170,9600
273 DATA 173,84,260,0,0,0,8170,9600,174,582,300,0,0,0,8170,9600
274 DATA 174,662,304,260,660,280,6162,10564,174,662,284,300,660,300,816
2,10564
275 DATA 174,662,224,200,660,200,8162,10564,174,761,0,0,0,0,1200,0
276 DATA 174,662,204,220,660,220,8162,10564,174,662,0,0,0,0,4500,0
277 DATA 176,462,800,0,0,0,8170,9600,177,204,0,0,0,0,5100,0
278 DATA 179,204,0,0,0,0,5100,0,179,284,0,0,0,0,5100,0
279 DATA 185,302,64,300,380,380,9354,10564,185,302,364,300,60,60,9354,1
0564
280 DATA 185,222,0,0,0,0,1200,0,193,842,560,0,0,0,8170,9600
281 DATA 201,0,0,0,0,0,1200,0,1050,604,0,0,0,0,9900,0
282 DATA 1050,724,0,0,0,0,9900,0,1050,260,0,0,0,0,7806,9900
283 DATA 1200,262,0,0,0,0,3750,0,1200,261,0,0,0,0,1243,0
284 DATA 1213,1162,1054,1040,0,0,7815,0,1215,0,0,0,0,9900,0
285 DATA 1216,0,0,0,0,0,3323,0,1223,84,0,0,0,0,1211,0
286 DATA 1224,662,660,660,0,0,8302,2250,1230,462,634,620,0,0,2452,0
287 DATA 1230,484,442,440,460,600,10852,150,1242,704,963,960,520,0,9402
,0
288 DATA 1245,544,880,0,0,0,7907,16200,1245,1062,1060,1000,0,10852
,17100
289 DATA 1249,0,0,0,0,0,10616,9150,1016,622,141,0,0,0,4650,0
290 DATA 1808,43,141,0,0,0,1231,0,1809,43,132,0,0,0,1246,0
291 DATA 1808,43,123,40,180,0,4672,10350,1810,183,40,180,0,0,2322,0
292 DATA 1816,662,132,0,0,0,1246,0,1816,662,121,680,700,0,10870,9620
293 DATA 1800,0,0,0,0,0,3400,0,2426,84,361,400,320,360,10855,2250
294 DATA 2437,261,0,0,0,0,3324,3450,2439,503,500,0,0,0,8373,1800
295 DATA 3174,204,61,60,660,0,4405,7950,3174,63,724,60,0,0,8352,15450
296 DATA 3174,204,61,60,660,0,4405,7950,3174,63,604,60,0,0,8352,15450
297 DATA 3174,63,60,0,0,0,2303,0,3178,84,361,400,320,360,10855,2250
298 DATA 3181,526,0,0,0,0,1350,0,3181,521,265,520,0,0,2303,0
299 DATA 3181,521,262,520,0,0,0,18053,0,3191,963,724,960,0,0,8352,15450
300 DATA 3191,604,920,0,0,0,8352,15450,3300,0,0,0,0,0,8613,0
301 DATA 3499,0,0,0,0,0,17550,0,3462,0,0,0,0,0,9750,0
302 DATA 3458,0,0,0,0,0,754,0,3469,0,0,0,0,0,763,0
303 DATA 3471,0,0,0,0,0,764,0,3472,0,0,0,0,0,764,0
304 DATA 3476,0,0,0,0,0,764,0,3480,0,0,0,0,0,671,0
305 DATA 3484,0,0,0,0,0,671,0,3492,0,0,0,0,0,763,0
306 DATA 3450,0,0,0,0,0,10564,0,3900,0,0,0,0,0,9750,0
307 DATA 4050,0,0,0,0,0,9900,0,4207,0,0,0,0,0,10650,0
308 DATA 4350,262,0,0,0,0,3750,0,4361,1062,1052,0,0,0,1203,0
309 DATA 4361,224,265,641,720,240,10615,600,4361,224,265,646,0,0,450,0
310 DATA 4361,1062,1043,1040,1060,0,10615,600,4361,1041,1220,1100,820,0
,10854
311 DATA 10564,4361,824,1046,0,0,0,1203,0,4369,161,134,120,0,0,7985,0
312 DATA 4369,161,133,0,0,0,1500,0,4369,161,154,140,0,0,7985,0
313 DATA 4360,0,0,0,0,0,2250,0,4392,0,0,0,0,0,10619,9150
314 DATA 4393,622,620,840,0,0,10615,600,4525,784,1160,260,0,0,10849,765
0
315 DATA 4525,262,620,0,0,0,8149,7500,4500,0,0,0,0,3600,0
316 DATA 4963,1162,1040,0,0,0,2302,0,4962,0,0,0,0,0,9750,0

```

Listing 1 (continued)

```

317 DATA 4963,1174,0,0,0,0,0,5400,0,0,4950,0,0,0,0,0,0,0,2700,0
318 DATA 5111,1062,1043,1060,1080,0,10815,450,5111,824,1041,1220,1100,0
    ,10815
319 DATA 450,5250,84,0,0,0,0,5850,0,5250,404,0,0,0,0,5400,0
320 DATA 5250,724,49,40,0,0,5805,0,5250,764,0,0,0,0,5105,0
321 DATA 5250,505,49,40,0,0,5805,0,5250,484,0,0,0,0,5150,0
322 DATA 5250,464,0,0,0,0,5150,0,5250,262,0,0,0,0,15400,0
323 DATA 5250,744,0,0,0,0,1050,0,5250,281,0,0,0,0,7850,0
324 DATA 5200,48,40,0,0,9106,0,5250,0,0,0,0,0,5550,0
325 DATA 5400,0,0,0,0,0,2850,0,5550,0,0,0,0,0,3150,0
326 DATA 5708,183,40,120,0,0,2322,0,5711,1082,1052,0,0,0,0,1246,0
327 DATA 5711,1082,1043,1060,1080,0,10815,500,5711,224,245,345,0,0,450,
    0
328 DATA 5711,824,1046,0,0,0,1246,0,5711,1041,1220,1100,820,0,10854,105
    ,64
329 DATA 5715,702,0,0,0,0,1322,0,5850,483,480,0,0,0,0,3055,0
330 DATA 5880,483,480,0,0,0,8265,3000,6000,503,500,0,0,0,3055,0
331 DATA 6023,0,0,0,0,0,900,0,6039,503,500,0,0,0,0,2270,0
332 DATA 6161,824,521,1100,1220,0,10815,504,6161,824,526,0,0,0,1246,0
333 DATA 6450,84,260,0,0,0,8170,9000,6450,284,260,0,0,0,8170,9600
334 DATA 6632,422,454,640,0,0,7985,150,6770,521,24,0,0,0,6000,0
335 DATA 6770,521,44,0,0,0,8000,0,6770,526,0,0,0,0,1246,0
336 DATA 6774,562,521,560,300,220,10640,8250,7080,621,0,0,0,0,4200,0
337 DATA 7080,501,753,0,0,0,7200,0,7080,601,754,740,0,0,0,5303,0
338 DATA 7080,464,0,0,0,0,3927,0,7236,763,760,0,0,0,0,7815,0
339 DATA 7536,761,760,0,0,0,7945,0,7450,824,780,0,0,0,0,6170,9600
340 DATA 7650,744,760,0,0,0,8170,9600,7650,764,740,0,0,0,0,6170,9600
341 DATA 7845,1183,1180,1200,0,0,10820,9660,7840,1203,0,0,0,0,3000,0
342 DATA 7900,0,0,0,0,0,3400,0,8260,702,0,0,0,0,1322,0
343 DATA AIT,ANY,GO,NORTH,VENT,SOUTH,WRUN,EAST,WRAL,WEST
344 DATANGLI,UP,WCRA,DOWN,JUST,GAN,GET,TOR,ATK,#ON
345 DATAPIC,OFF,#BAT,DOO,LIG,SCO,#TUR,KEY,#TOR,HEL
346 DATANBUR,INU,DRO,SIG,#REL,ARO,#SPI,FIR,#LER,KNA
347 DATANGUI,TRE,THR,HIL,GUT,CRU,LOO,WAT,#SHU,RUP
348 DATANSEE,GUA,SCO,PAS,INU,OPE,SAU,PIL,OPE,HAL
349 DATA ATT,BOO,#KIL,AXE,#FIG,PIA,FIN,#MUS,LOC,GRA
350 DATA HEL,DRA,SAY,HOR,STD,ARM,UNL,F00,EAT,WIN
351 DATA DRI,PRI,BRE,LAD,#SWA,CHE,SWI,COF,PLA,#STA
352 DATA CUT,TOA,#OH0,SKU,REA,BAT,RID,BAR,#YOU,COB
353 DATA DIS,#HEB,IWA,LED,KYS,"",#LOU,"",#FUC,""
354 DATA FIR,"",,"",,"",,"",,"",,"",,"",,"",,"",,"",,"",,"",,""
355 DATA 0,0,0,0,0,0,""
356 DATA 1,4,1,2,0,0,A THICK WOODS
357 DATA 2,4,1,5,0,0,A DARK FOREST
358 DATA 0,0,0,0,0,1,*YOU ARE ON A BRANCH NEAR THE TOP OF A TREE
359 DATA 1,0,0,0,0,0,*YOU ARE BY THE WATER'S EDGE OF THE MORT
360 DATA 0,0,2,0,0,0,A CLEARING BY THE SIDE OF A SMALL HILL
361 DATA 0,0,5,0,0,0,*YOU ARE BY THE ENTRANCE TO A CAVE
362 DATA 0,7,5,8,7,0,A LARGE CAVERN WITH TUNNELS GOING OFF IN ALL DIRE
    CTIONS
363 DATA 8,8,7,8,9,8,A SMALL CAVERN WITH MANY OPENINGS LEADING FROM
    IT
364 DATA 0,8,8,10,9,8,A LOU PASSAGE--MAY
365 DATA 0,0,0,0,0,0,A LARGE CAVERN WITH HIGH SHEER WALLS
366 DATA 0,0,0,0,0,0,A SMALL ROOM CARVED INTO THE CAVE WALL

```

Listing 1 (continued)

```

367 DATA 2,1,0,0,0,0,5
368 DATA#YOU ARE ON THE TOP OF A SMALL HILL--THE CASTLE IS SOUTH
369 DATA 4,14,0,0,0,0,THE WATER--IT IS ICY COLD
370 DATA 13,0,0,0,0,0,*YOU ARE BY THE OUTER CASTLE WALLS
371 DATA 0,0,18,0,16,0,*YOU ARE ON A CATWALK NEAR THE WEST TOWER
372 DATA 0,0,0,17,0,15,A SMALL CHAMBER IN THE WEST TOWER
373 DATA 0,0,16,0,0,0,THE GUARDS' QUARTERS
374 DATA 0,0,20,15,0,19,THE WEST END OF A GREAT HALL
375 DATA 23,0,0,0,18,0,THE CASTLE COURTYARD
376 DATA 21,0,0,18,24,0,THE EAST END OF THE GREAT HALL
377 DATA 0,20,0,19,0,0,THE KITCHEN
378 DATA 18,0,0,0,0,25,A SECRET PASSAGE BEHIND THE FIREPLACE
379 DATA 0,19,0,0,0,0,THE CASTLE'S STABLES
380 DATA 0,0,0,0,26,20,THE BARON'S PRIVATE CHAMBERS
381 DATA 0,0,0,0,22,27,A LONG LOU TUNNEL SLOPING DOWNWARD
382 DATA 0,0,0,0,24,THE TURRET ROOM OF THE EAST TOWER
383 DATA 0,0,0,0,25,0,THE BARON'S FAMILY CRYPT
384 DATA 0,0,29,0,27,0,A CAVERN WITH IRIDESCENT GLOWING WALLS
385 DATA 0,30,0,28,0,0,AN ODD-SHAPED ROOM WITH A STRANGE SMELL
386 DATA 29,0,0,0,0,0
387 DATA#YOU ARE ON A LEDGE ON THE NORTH SIDE OF A DEEP AND WIDE CHASM
388 DATA 32,11,0,34,0,0,THE EAST END OF A LARGE CAVERN
389 DATA 33,31,0,0,0,35,*YOU ARE AT A CROSS-ROADS IN A LONG TUNNEL
390 DATA 0,0,0,0,0,0,*YOU ARE LOST IN THE PET ROMS CAVERN
391 DATA 35,0,31,0,0,0,THE WEST END OF A LARGE CAVERN
392 DATA 0,34,36,0,32,0,THE BARON'S SECRET STRONGHOLD
393 DATA 0,0,0,0,35,0,0
394 DATA#YOU ARE ON A LEDGE ON THE SOUTH SIDE OF A DEEP AND WIDE CHASM
395 DATA 0,0,0,0,0,0,THE BARON'S TREASURE ROOM
396 DATA 38,39,0,0,0,38,39,A TWISTING TUNNEL IN THE DUNGEON
397 DATA 38,39,0,0,38,39,A LONG PASSAGE--MAY WITH ROOMS OF CELLS
398 DATA 0,0,37,24,0,0,A SECRET PASSAGEWAY
399 DATA 0,0,0,0,0,0,A DUNGEON CELL
400 DATA 33,5,33,33,33,12,*PICK A DIRECTION AND YOU MIGHT RETURN TO LIFE
401 DATA "" , "THERE'S A STRANGE SOUND,NOTHING HAPPENS,IT'S LOCKED,IT'S OP
    EN
402 DATA THERE'S SOMETHING THERE--MAYBE YOU SHOULD
403 DATA THAT'S NOT VERY SAFE, YOU MAY NEED MAGIC HERE,SORRY...YOU CAN'T
404 DATA YOU DON'T HAVE IT,IT'S EMPTY, YOU HAVE NO CONTAINER
405 DATA WHAT A WASTE...OPEN IT?GO THERE?OK...YOU FOUND SOMETHING!
406 DATA YOU DIDN'T FIND ANYTHING
407 DATA TO STOP GAME SHY QUIT,A VOICE BOOMS OUT...LEAVE IT ALONE!
408 DATA DON'T BE SILLY!,THE GUARD WON'T LET YOU!,THE BARON SUCKS EGGS!
409 DATA THE HOOK CATCHES AND THE ROPE HANGS DOWN
410 DATA YOU HAVE TO THROW IT FIRST!,THE MATCHES ARE TOO HOT,IT IS BLAZ
    ING
411 DATA AN ANGRY-LOOKING GUARD APPEARS,IT'S TOO HIGH AND STEEP
412 DATA SOMETHING FELL OUT
413 DATA YOU NEED SOME EXERCISE,/CRASH...IT'S DOWN!,READING IMPROVES THE
    MIND
414 DATA THE GUARD THROWS YOU OVER THE EDGE,WITH A BROKEN ARM
415 DATA YOUR ARM HAS HEALED,THE GUARD MISTAKES YOU FOR THE BARON ANDLE
    AVES

```

Listing 1 (continued)

```

419 DATA YOU DON'T HAVE THE NECESSARY RESOURCES, TIME HEALS ALL THINGS
420 DATA TRY ANOTHER BOOK, IT WAS A FIERCE FIGHT, BUT YOU LOST
421 DATA BUT YOU FINALLY WON, IT DISAPPEARS, INTO THE CHASM
422 DATA LEAVE PERFECTLY!, THEN SOMETHING, SORRY ABOUT THAT
423 DATA THE SKULL SPEAKS---BEWARE THE VAMPIRE, BEHOLD THE CHEST
424 DATA BEWARE THE GOLD BARS, YOU JUST LOST YOUR CURSOR AND THE GAME I
    3: OVER
425 DATA LEAVE THE GUARD IN HIS QUARTERS, THE BAT JUST BITE YOU
426 DATA THE DOOR SLAMS SHUT!, YOU HEAR THE FLAP OF WINGS
427 DATA THE TORD SAYS---RIB-BIT!
428 DATA YOU SEE A POISONOUS SPIDER CRAWLING    TOWARD YOU
429 DATA YOU WERE JUST BITTEN BY A POISONOUS SPIDER
430 DATA THE BARON SUDDENLY APPEARS WITH A LARGE SWORD AND IT'S OFF
431 DATA IT MISSED!, READ IT?, YOU HAVE NO WATER, THE BOTTLE SHATTERS!
432 DATA TREES, 1, TREES, 2, UNLITE TORCH, TOR, /, 6
433 DATA ROPE WITH GRAPPLING HOOK ON END, /ROP, /, 9, /, HAVE IN THE SIDE OF THE
    HILL, /, 5
434 DATA SIGN SAYING---NO SWIMMING---DANGER!, 4, MATCHES, /MAT, /, 0, /, SOGGY MATCH
    ES, /MAT, /
435 DATA 16, KNAPSACK, /KNA, /, -, 1, /, BLAZING TORCH, /TOR, /, 0, /, THE CASTLE ACROSS THE
    WATER, /, 4
436 DATA THE DRAWBRIDGE IS UP, /, 4, A HEVY OAK DOOR, /, 11, /, AN ANGRY-LOOKING GU
    ARO, /, 11
437 DATA A BROKEN ARM, /, 0, /, THE DRAWBRIDGE IS DOWN, /, 0
438 DATA A SCHOOL OF MAN-EATING PIRANHA, /, 13
439 DATA SIGN -- LEAVE TREASURE HERE--SAY 'SCORE', /, 12
440 DATA OPENING IN THE WALL--HIGH UP NEAR THE TOP OF THE CAVERN, /, 10
441 DATA MAGIC SLEEPING PILLS, /, PIL, /, 12, /, A SCHOOL OF SLEEPY PIRANHA, /, 0
442 DATA A GRAND PIANO, /, 20, /, A BOOKCASE FILLED WITH CLASSICS, /, 24
443 DATA A SECRET PASSAGE BEHIND THE BOOKCASE, /, 0, /, FOOD, /, 21, /, WINE, /, WIN, /,
    21
444 DATA A BATTLE AXE, /, AXE, /, 17, /, GRAFFITI ON THE WALLS, /, 23
445 DATA A THICK ROPE HOLDING THE DRAWBRIDGE UP, /, 19, /, SILVER SUIT OF ARMO
    R, /, ARM, /,
446 DATA 24, /, A BOOK OF HORROR STORIES, /, BOO, /, 0, /, RARE 1ST EDITION OF SCOTT#
    /, BOO, /, 0
447 DATA SOME PIANO KEYS, /, KEY, /, 0, /, A ROPE HANGING DOWN, /, 0, /, A FIREPLACE, /, 18
448 DATA A FIREPLACE WITH A BLAZING FIRE, /, 0, /, AN OPEN DOOR, /, 0
449 DATA A LARGE DIAMOND, /, DIA, /, 0, /, THE BARON'S BEST HORSE, /, HOR, /, 23, /, MUDDY
    WATER
450 DATA 4, /, JEHELED URN, /, URN, /, 27, /, COFFIN, /, AN OPEN COFFIN WITH STAIRS I
    NSIDE, /, 0
451 DATA BONES, /, BON, /, 27, /, SKULL, /, SKUL, /, 27, /, A VAMPIRE BAT, /, 0, /, BAG OF RUBIES, /, RU
    B, /, 29
452 DATA SIGN---DANGER---GO BACK!, /, 32, /, TREASURE CHEST, /, CHE, /, 35, /, A LONG LADD
    ER, /, LAD, /,
453 DATA 36, /, GOLD BARS, /, BAR, /, 37, /, SILVER CROSS, /, CRO, /, 37, /, GUARD'S KEYS, /, KEY
    /, 0
454 DATA AN OPEN DOORWAY, /, 37, /, A LOCKED STEEL DOOR, /, 0, /, A LOCKED OAK DOOR, /, 41
455 DATA ANOTHER LEDGE ON THE NORTH SIDE, /, 36, /, A NARROW LEDGE ON THE OTHER
    SIDE
456 DATA 30, /, AN UNCONSCIOUS GUARD, /, 0, /, A HORNY TORD, /, TOR, /, 41
457 DATA BEAUTIFUL PRINCESS, /, PRI, /, 0, /, AN OPEN DOORWAY, /, 0, /, THE CASTLE TO THE
    SOUTH
458 DATA 3, /, COBNEBS, /, 27, /, COBNEBS, /, 35, /, COBNEBS, /, 38

```

Listing 2: Changes to Listing 1 for Apple II

```

1 HOME : VTAB 4: HTAB 6: PRINT "Welcome to CASTLE ADVENTURE
2 HTAB 10: PRINT "By David Malinberg
3 VTAB 8: HTAB 3: PRINT "Based on the Ideas, Data Structure
4 HTAB 3: PRINT "and Driver Program of Scott Adams
5 VTAB 12: PRINT "Reading Data Tables --- Just a moment
21 HOME
22 R = ARLX = LT:DF = 0:SF = 0: INPUT "Use Saved Game(Y or N)? ";K$
23 IF LEFT$(K$,1) < "Y" THEN HOME : GOTO 37
24 REM Delete lines 24-29
30 INPUT "Filename? ";LT$: IF LEN(LT$) = 0 THEN 30
31 D$ = CHR$(4): PRINT D$:"OPEN"LT$
32 REM Delete 32-33
34 PRINT D$:"READ"LT$: INPUT SF: INPUT LX: INPUT DF: INPUT R
35 FOR X = 0 TO IL: INPUT IA(X): NEXT
36 PRINT D$:"CLOSE"
38 PRINT : INPUT "What do you want to do? ";TP$: PRINT : GOSUB 45
69 FOR Z = 0 TO IL: IF K AND IA(Z) = R THEN PRINT : PRINT "Visible items here:";
    K = 0
76 GOSUB 71: IF PEEK(36) + LEN(TP$) + 3 > 39 THEN PRINT
142 IF NOT L THEN HOME
161 FOR X = 0 TO IL:IA(X) = I2(X): NEXT : HOME : GOTO 22
169 GOSUB 71: IF PEEK(36) + LEN(TP$) > 39 THEN PRINT
175 HOME
219 HOME
220 REM Delete 220-225
226 INPUT "Filename? ";LT$: IF LEN(LT$) = 0 THEN 226
227 D$ = CHR$(4): PRINT D$:"OPEN"LT$
228 REM Delete 228-229
230 PRINT D$:"WRITE"LT$: PRINT SF: PRINT LX: PRINT DF: PRINT R
231 FOR W = 0 TO IL: PRINT IA(W)
232 REM Delete
233 NEXT : PRINT D$:"CLOSE"

```





CHRISTMAS SEASON SPECIALS!

Let ARK COMPUTING Make This Your Best Christmas Ever!

Super Fan II by R.H. Electronics **59.95/79.95**

Applicard, a high performance Z-80 card with 64K Ram, complete with CP/M
4 mhz **324.95/445.00**
6 mhz **395.00/595.00**

Microsoft Z-80 card with CP/M and Microsoft Basic
2 mhz **269.95/395.00**

Microtek Parallel Printer Interface complete with centronic compatible connector
64.95/79.95

Lazer Lower Case +Plus with Character Set +Plus **49.95/84.90**
Lower Case +Plus alone **39.95/59.95**

Lazer Graphics +Plus **99.95/159.95**
Graphics +Plus and Lower Case +Plus **134.95/219.90**

Computer Stop 16K Ram Board **69.95/149.95**

Computer Stop Omnivision 80 Column board
129.95/295.00

Videx Video-term with softswitch, inverse character set and 80 column Visicalc preboot
295.00/450.00

Wizard BPO 16K buffered printer interface (expandable to 32K) **134.95/179.95**

Wizard 80, 80 column board **195.00/295.00**

Lazer Pascal **29.95/39.95**

Anix 1.0 **34.95/49.95**

Lazer Forth **44.95/59.95**

D Tack 68000 board for the Apple II with 4K Ram **895.00**

Lazer Model/32 (16032 board for the Apple II)
CALL!

Lisa	59.95/79.95
Lisa Educational Pak	79.95/119.95
Alien Ambush	19.95/29.95
Bandits	19.95/29.95
Cannonball Blitz	24.95/34.95
County Fair	19.95/29.95
Cranston Manor	24.95/34.95
Cyclod	19.95/29.95
David's Midnight Magic	24.95/34.95
Dosource 3.3	24.95/39.95
Dueling Digits	19.95/29.95
Falcons	21.95/29.95
Firebird	21.95/29.95
Foosball	19.95/29.95
Horizon V	25.95/34.95
Genetic Drift	19.95/29.95
Kabul Spy	24.95/34.95
Jelly Fish	19.95/29.95
Lemmings	19.95/29.95
Labyrinth	19.95/29.95
Mouskattack	24.95/34.95
Outpost	19.95/29.95
Red Alert	19.95/29.95
Pig Pen	24.95/34.95
Ruski Duck	25.95/34.95
Minator	24.95/34.95
Track Attack	19.95/29.95
Thief	17.95/29.95
Space Quarks	19.95/29.95
Snack Attack	19.95/29.95
Swash Buckler	24.95/34.95
Gin Rummy	24.95/34.95
The Dictionary	69.95/99.95
General Manager	99.95/149.95
4 Ft. Disk Cable	19.95/29.95
Visicalc	179.95/250.00
Using 6502 Assembly Language Book	14.95/19.95
Kids and The Apple Computer Book	15.95/19.95
Apple Panic	19.95/29.95
Kraft Joystick	49.95/69.95



Your Salvation In The Sea Of Inflation.

714 735-2250
P.O. Box 2025
Corona, CA 91720



ROCKWELL Microcomputers from Excert, Inc.

THE AIM 65/40 Single Board or Smorgasbord



- A full size terminal style keyboard w/8 special function keys
- A smart, 40 character display with its own microprocessor
- A 40 column printer w/text and graphic output
- Up to 64K of on-board RAM and ROM
- On-board interfaces include RS232, dual audio cassette and 2 user I/O R6522 devices
- Firmware includes interactive monitor and text editor w/options of Assembler, BASIC, FORTH and PL/65

THE AIM 65 Take-Out Order



- A full size terminal style keyboard w/3 special function keys
- A 20 character display
- A 20 column printer w/text and graphic output capability
- Up to 4K RAM and 20K ROM on-board
- On-board interfaces include 20MA TTY, dual audio cassette and 1 user I/O R6522 device
- Firmware includes interactive monitor and text editor w/options of Assembler, BASIC, FORTH, PASCAL, & PL/65

And if the above isn't enough,
Try the RM65 — a product line filled with embellishments including:

32K DRAM Board
CRT Controller
Floppy Disk Controller
PROM Programmer

ACIA Board
IEEE-488Board
CPU/SBC Board
4-16 Slot Card Cages

Prototype cards
Adaptor Buffer Modules
General Purpose I/O Board
PROM/ROM Board

NEW LOWER PRICES AND A CASH DISCOUNT* TO BOOT!

A65/40-16 (16K RAM)	\$1225
A65/40-32 (32K RAM)	\$1295
A65/40-A (Assembler)	\$ 85
A65/40-B (BASIC)	\$ 65

A65-1 (1K RAM)	\$420
A65-4 (4K RAM)	\$445
A65-4B (4K RAM w/BASIC)	\$495
A65-PS (PASCAL)	\$100
A65-F (FORTH)	\$ 65
A65-A (Assembler)	\$ 35

Mail Order to:

Educational Computer Division EXCERT INCORPORATED

- SALES
- SERVICE
- INSTALLATION
- CONSULTING

P.O. Box 8600
White Bear Lake, MN 55110
(612) 426-4114

Higher quantities quoted upon request, COD's accepted, shipping will be added. *Deduct 5% cash discount on prepaid orders. Minnesota residents add 5% sales tax. Prices subject to change without notice.

SYM 23 Matches

by Matt Ganis

Two players alternate, removing matches from a pile of 23; the player taking the last match loses. On each turn a player may take 1, 2, or 3 matches.

23 Matches
requires:
1K SYM

In this version of the game the human challenges the computer. Key in G 0200 to begin the game. The LEDs will go blank and the SYM will wait for you to press any key on the keypad. Once this is done the computer informs the player that it is his turn. At this point the player enters either a 1, 2, or 3 (taking away 1, 2, or 3 matches). The SYM will inform the player of the number of matches it is taking by scrolling the message 'I SELECT....'

Modifications to the program are very simple:

1. To change the speed of the messages that scroll on the display, decrement the value at location \$02FA.
2. To make the computer move first, change the 0 at location \$0204 to 1.
3. To alter the number of matches used, change the \$17 (hex \$17, decimal 23) to the number of matches desired.

The only part of the program that might be used in another program is the 'display-a-message' routine at location \$02EE. This routine will scroll a message across the SYM displays starting at the right-most display and ending at any desired display. Just set the zero page pointer (PTR) to the location of the message (lo, hi), and load the Y register with the number of displays to be used minus one. Then do a JSR MESSAGE.

Mr. Ganis studies computer science at PACE University (Pleasantville/Briarcliff). He may be contacted at Sheridan Road R.D. #3, Lebanon, NJ 08833.

23 Matches

```

; THIS IS A GAME OF 23 MATCHES.
; EACH PERSON (THE COMPUTER AND
; THE PLAYER) TAKE TURNS TAKING
; AWAY MATCHES FROM THE PILE.

; ON EACH TURN YOU MAY TAKE ONLY
; 1, 2 OR 3 MATCHES. THE PLAYER
; TAKING THE LAST MATCH LOSES !!

; BASIC VERSION FROM -

; 101 BASIC COMPUTER GAMES
;   EDITED BY DAVID H. AHL

; TO START GAME KEY ' G 0200 '

; ***ZERO PAGE LOCATIONS USED

80: 0200 MOVE = $00 ;WHOSE MOVE IT IS
81: 0200 MATCHES = $01 ;NUMBER OF MATCHES
82: 0200 DISPLAY = $02 ;LAST DISPLAY USED
83: 0200 RND = $04 ;RANDOM NUMBER
84: 0200 PTR = $05 ;POINTER FOR MESSAGES
85: 0200 COUNT1 = $07 ;DELAY COUNTER 1
86: 0200 COUNT2 = $08 ;DELAY COUNTER 2
87: 0200 TEMP = $09 ;TEMP. STORAGE
88: 0200 REG = $0A ;1ST REG. COMPUTER MOVE
89: 0200 SYMMOVE = $0B ;COMPUTER'S MOVE
90: 0200 REG2 = $0C ;2ND REG. COMPUTER MOVE
91: 0200 TEMP2 = $0D ;TEMP. STORAGE 2

;
; ***MONITOR LOCATIONS USED***

93: 0200 GETKEY = $88AF ;GET A KEY FROM KEYPAD

;
94: 0200 LED = $A640 ;LOCATION OF 1ST DISPLAY
95: 0200 SCAND = $8906 ;SCAN THE DISPLAY
96: 0200 ACCESS = $8B86 ;ENABLE SYSTEM RAM
97: 0200 SEGCODES = $8C29 ;TABLE OF SEGMENT CODES
98: 0200 KEYSTAT = $896A ;IF A KEY IS DOWN C=1

;
100: 0200 *= $0200

110: 0200 20 86 8B MAIN JSR ACCESS ;ENABLE RAM
121: 0203 A9 00 LDA #0
121: 0205 85 00 STA MOVE ;PLAYER FIRST
130: 0207 A9 17 LDA #23
130: 0209 85 01 STA MATCHES ;MATCHES=23
140: 020B A9 42 LDA ##42
140: 020D 85 02 STA DISPLAY
140: 020F A9 A6 LDA ##A6
140: 0211 85 03 STA DISPLAY+1
150: 0213 E6 04 RANDOM INC RND ;GENERATE RANDOM #
160: 0215 20 6A 89 JSR KEYSTAT ;WAIT FOR KEY DOWN
165: 0218 90 F9 BCC RANDOM ;IF NO KEY,BUMP RND

```

(continued)

MICRO™

New Publications

40 Computer Games from Kilobaud Microcomputing, edited by Emily A. Gibbs and Jim Perry. Wayne Green, Inc. (Peterborough, NH), 1980, 148 pages, paperback. \$7.95

40 Computer Games offers you some of the best game programs from recent issues of *Kilobaud Microcomputing*. Nine game categories offer something for everyone. Accompanying articles explain how to play the games and increase the odds to beat the computer. The games are written in different languages for various computer systems.

CONTENTS: Gambling; Racing; Space; Board Games; Card Games; Guessing Games; Puzzles; Calculators; Odds and Ends.

Science and Engineering Sourcebook by Cass Lewart. Micro Text Publications Inc. (One Lincoln Plaza, Suite 27C, New York, NY 10023), 1982, 95 pages, 6 x 9 inches, paperback. ISBN: 0-942412-02-8 \$9.95

A book of professional applications programs for the TRS-80 Pocket Computer. The programs cover problems in the field of electrical engineering, statistics, queuing theory, reliability, graph generation, artificial intelligence, and related technical disciplines. A table of conversions make the translation of these programs applicable to other BASIC computers.

CONTENTS: Foreword; Introduction; Electrical Engineering; Data Transmission; Number Theory; Computer Programming; Computer Generated Plotting; Probability and Statistics; Mathematics; Operations Research; Miscellaneous; Appendix.

Games for the ATARI, by S. Roberts. Elcomp Publishing, Inc. (53 Redrock Lane, Pomona, CA 91766), 1982, 115 pages, paperback. ISBN: 3-911682-84-3 \$7.95

Games for the Atari provides ideas on how to create your own computer games. This booklet deals primarily with BASIC examples with only one example in machine language. Atari programs show the possibilities of using both graphics and sound features.

CONTENTS: Drawing Figures on the Screen; Movements in BASIC; Movements in Machine Language; Movements of Missiles; Overlapping Detection; Sound-

(Continued on next page)

23 Matches (continued)

166:	021A	A9 00	PRINT	LDA	#0	PRINT MATCHES
167:	021C	85 09		STA	TEMP	
168:	021E	A5 01		LDA	MATCHES	
170:	0220	38	PNT2	SEC		DETERMINE TENS
172:	0221	E9 0A		SBC	##0A	BY SUCCESSIVE
174:	0223	30 04		BMI	PNT3	SUBTRACTIONS OF 10
176:	0225	E6 09		INC	TEMP	BUMP TENS SPOT
178:	0227	D0 F7		BNE	PNT2	BRANCH ALWAYS
180:	0229	18	PNT3	CLC		
182:	022A	69 0A		ADC	##0A	ADD 10 BACK
184:	022C	AA		TAX		TO GET UNITS
186:	022D	BD 29 8C		LDA	SEGCODES,X	GET SEGMENT CODE
188:	0230	8D 41 A6		STA	LED+1	2ND DISPLAY
190:	0233	A6 09		LDX	TEMP	GET TENS
192:	0235	BD 29 8C		LDA	SEGCODES,X	GET THE CODE
194:	0238	8D 40 A6		STA	LED	1ST DISPLAY
196:	023B	A5 01		LDA	MATCHES	TEST FOR ZERO
198:	023D	D0 03		BNE	OVER	MATCHES, BRANCH IF N.
200:	023F	4C D0 02		JMP	LOST	SOMEONE LOST !!
202:	0242	A9 01	OVER	LDA	#1	DETERMINE WHOSE
204:	0244	38		SEC		MOVE IT IS BY
206:	0245	E5 00		SBC	MOVE	COMPUTING MOVE=1-MOVE
208:	0247	85 00		STA	MOVE	
210:	0249	F0 27		BEQ	COMPUTER	IF 0 COMPUTER'S MOVE
212:	024B	A9 1B		LDA	#CPLYRMOVE	PRINT THE
214:	024D	85 05		STA	PTR	"YOUR MOVE"
216:	024F	A9 03		LDA	#>PLYRMOVE	MESSAGE
218:	0251	85 06		STA	PTR+1	
220:	0253	20 EE 02		JSR	MESSAGE	DISPLAY IT
222:	0256	20 AF 88	GET	JSR	GETKEY	WAIT FOR PLAYERS
224:	0259	C9 34		CMP	##34	MOVE
226:	025B	B0 F9		BCS	GET	BRANCH IF KEY<>'4'
228:	025D	C9 31		CMP	##31	
230:	025F	90 F5		BCC	GET	BRANCH IF KEY<'1'
232:	0261	38		SEC		CONVERT FROM ASCII
234:	0262	E9 30		SBC	##30	TO INTEGER
236:	0264	85 09		STA	TEMP	KEEP IN TEMP
238:	0266	A5 01		LDA	MATCHES	MAKE SURE PLAYER
240:	0268	38		SEC		DIDN I TAKE MORE
242:	0269	E5 09		SBC	TEMP	THAN WHAT'S IN FILE
244:	026B	30 E9		BMI	GET	BRANCH IF 30
246:	026D	85 01		STA	MATCHES	ELSE STORE RESULT
248:	026F	4C 1A 02		JMP	PRINT	AND CONTINUE.
COMPUTER'S MOVE						
250:	0272	A5 01	COMPUTER	LDA	MATCHES	IF MATCHES=1
252:	0274	C9 01		CMP	#1	COMPUTER LOST
254:	0276	D0 03		BNE	CMOVE	
256:	0278	4C AD 02		JMP	FINISH	JUMP WITH ACC=1
258:	027B	4A	CMOVE	LSR		COMPUTE -
260:	027C	4A		LSR		4R=4*INT(MATCHES/4)
262:	027D	0A		ASL		
264:	027E	0A		ASL		
266:	027F	85 0A		STA	REG	KEEP IT IN REG
268:	0281	38		SEC		COMPUTE -
270:	0282	A5 01		LDA	MATCHES	4R=MATCHES-REG
272:	0284	E5 0A		SBC	REG	
274:	0286	85 0A		STA	REG	KEEP IT IN REG
276:	0288	C9 01		CMP	#1	IF REG=1 THEN
278:	028A	D0 13		BNE	CMOVE3	MAKE RANDOM MOVE
RANDOM NUMBER GENERATOR						
280:	028C	D8	CMOVE2	CLD		BINARY ADDITION
282:	028D	A5 04		LDA	RND	GET RND
284:	028F	0A		ASL		COMPUTE -
286:	0290	0A		ASL		RND=4*RND
288:	0291	18		CLC		
290:	0292	65 04		ADC	RND	RND=5*RND
291:	0294	18		CLC		
291:	0295	69 01		ADC	#1	RND=5*RND+1
292:	0297	85 04		STA	RND	
294:	0299	29 03		AND	##00000011	MAKE SURE 1<RND<3
296:	029B	F0 EF		BEQ	CMOVE2	NO ZERO'S ALLOWED
298:	029D	D0 12		BNE	DONE	BRANCH ALWAYS
300:	029F	18	CMOVE3	CLC		
302:	02A0	A5 0A		LDA	REG	COMPUTE -
304:	02A2	69 03		ADC	#3	REG2=REG+3
306:	02A4	85 0C		STA	REG2	
308:	02A6	4A		LSR		COMPUTE -
310:	02A7	4A		LSR		4*INT(REG2/4)
312:	02A8	0A		ASL		
314:	02A9	0A		ASL		
316:	02AA	85 0D		STA	TEMP2	AND KEEP IN TEMP2
318:	02AC	38		SEC		DETERMINE MOVE BY

23 Matches (continued)

```

320: 02AD A5 00 FINISH LDA REG2 ;COMPUTING -
322: 02AF E5 00 SBC TEMP2 ; REG2-TEMP2
324: 02B1 85 0B DONE STA SYMMOVE ;THIS IS COMPUTER'S MOVE
326: 02B3 38 SEC
328: 02B4 A5 01 LDA MATCHES ;TAKE AWAY FROM FILE
330: 02B6 E5 0B SBC SYMMOVE
332: 02B8 85 01 STA MATCHES ;PUT RESULT BACK
334: 02BA A6 0B LD% SYMMOVE ;GET SEGMENT CODE
336: 02BC 8D 29 8C LDA SEGCODES,X ;OF COMPUTER'S MOVE
338: 02BF 8D 51 03 STA COMPBYTE+1 ;STORE IN MESSAGE
340: 02C2 A9 44 LDA #<COMPMOVE ;PRINT THE
342: 02C4 85 05 STA PTR ;"I SELECT X"
344: 02C6 A9 03 LDA #>COMPMOVE ;MESSAGE
346: 02C8 85 06 STA PTR+1
348: 02CA 20 EE 02 JSR MESSAGE ;DISPLAY IT
350: 02CD 4C 1A 02 JMP PRINT ;CONTINUE
352: 02D0 A5 00 LOST LDA MOVE ;SOMEONE LOST
354: 02D2 C9 01 CMP #1 ;WHO IS IT PRINT
356: 02D4 F0 0A BEQ PLAYER ;IF MOVE=1 THEN PLAYER
358: 02D6 A9 57 LDA #<COMPLOSE ;PRINT THE
360: 02D8 85 05 STA PTR ;"I LOSE .."
362: 02DA A9 03 LDA #>COMPLOSE ;MESSAGE
364: 02DC 85 06 STA PTR+1
366: 02DE D0 08 BNE DISMES ;BRANCH ALWAYS!
368: 02E0 A9 2D PLAYER LDA #<PLYRLOSE ;PRINT THE
370: 02E2 85 05 STA PTR ;"YOU LOSE .."
372: 02E4 A9 03 LDA #>PLYRLOSE ;MESSAGE
374: 02E6 85 06 STA PTR+1
376: 02E8 20 EE 02 DISMES JSR MESSAGE ;DISPLAY IT
378: 02EB 4C 00 02 JMP MAIN ;START ALL OVER

```

DISPLAY A MESSAGE

```

380: 02EE A0 03 MESSAGE LDY #3 ;NUMBER OF DISPLAYS-1
382: 02F0 B1 05 MESS1 LDA (PTR),Y ;GET A BYTE
384: 02F2 30 20 BMI BYE ;IF NEG, STOP
386: 02F4 91 02 STA (DISPLAY),Y ; DISPLAY IT
388: 02F6 88 DEY
390: 02F7 10 F7 BPL MESS1 ;KEEP GOING
392: 02F9 A9 02 DELAY LDA #2 ;DELAY A LITTLE BIT
394: 02FB 85 07 STA COUNT1
396: 02FD A9 FF D1 LDA #FF
398: 02FF 85 08 STA COUNT2
400: 0301 20 06 89 D2 JSR SCAND ;SCAN THE DISPLAY
402: 0304 C6 08 DEC COUNT2
404: 0306 D0 F9 BNE D2
406: 0308 C6 07 DEC COUNT1
408: 030A D0 F1 BNE D1 ;BUMP PTR
410: 030C E6 05 INC PTR
412: 030E D0 02 BNE D3
414: 0310 E6 06 INC PTR+1 ;DOUBLE BUMP
416: 0312 D0 DA D3 BNE MESSAGE ;BRANCH ALWAYS
418: 0314 60 BYE RTS

```

```

418: 031B *= $31B
450: 031B 00 00 00 PLYRMOVE .BYTE $00,$00,$00 ;DATA FOR THE
452: 031E 00 6E 5C .BYTE $00,$6E,$5C ;"YOUR MOVE"
454: 0321 10 50 00 .BYTE $10,$50,$00 ; MESSAGE
456: 0324 78 10 50 .BYTE $78,$10,$50
458: 0327 54 00 00 .BYTE $54,$00,$00
460: 032A 00 00 80 .BYTE $00,$00,$80

```

```

470: 032D 00 00 00 PLYRLOSE .BYTE $00,$00,$00 ;DATA FOR THE
472: 0330 00 6E 5C .BYTE $00,$6E,$5C ;"YOU LOSE.."
474: 0333 10 00 38 .BYTE $10,$00,$38 ; MESSAGE
476: 0336 3F 6D 79 .BYTE $3F,$6D,$79
478: 0339 00 76 77 .BYTE $00,$76,$77
480: 033C 00 76 77 .BYTE $00,$76,$77
482: 033F 00 00 00 .BYTE $00,$00,$00
484: 0342 00 80 .BYTE $00,$80

```

```

490: 0344 00 00 00 COMPMOVE .BYTE $00,$00,$00 ;DATA FOR THE
492: 0347 00 06 00 .BYTE $00,$06,$00 ;"I SELECT X"
494: 034A 6D 79 38 .BYTE $6D,$79,$38 ; MESSAGE
496: 034D 79 39 78 .BYTE $79,$39,$78
498: 0350 00 FF 00 COMPBYTE .BYTE $00,$FF,$00
500: 0353 00 00 00 .BYTE $00,$00,$00
502: 0356 80 .BYTE $80

```

```

520: 0357 00 00 00 COMPLOSE .BYTE $00,$00,$00 ;DATA FOR THE
522: 035A 00 06 00 .BYTE $00,$06,$00 ;"I LOSE.."
524: 035D 38 3F 6D .BYTE $38,$3F,$6D ; MESSAGE
526: 0360 79 00 7C .BYTE $79,$00,$7C
528: 0363 5C 5C 00 .BYTE $5C,$5C,$00
530: 0366 78 06 6D .BYTE $78,$06,$6D
532: 0369 6D 00 00 .BYTE $6D,$00,$00
534: 036C 00 00 80 .BYTE $00,$00,$80

```

New Publications (continued)

features; Programming the Joystick; Backgammon; SMARTY; BOMBER; ROBOT ATTACK; BALL; SMART; BARRIER; KNIGHT-BATTLE; CALENDAR; GUNFIGHT; Appendix; The Video Processor "ANTIC" and the Atari 400/800; Display List Interrupts and the Atari, Atari 400/800 and CTIA/GTIA; The Atari 400/800 and its Character Set.

Apple II Assembly Language, by Marvin L. De Jong. Howard W. Sams & Co., Inc. (4300 West 62nd St., Indianapolis, IN 46268), 1982, 334 pages, 5 1/4 x 8 1/2 inches, paperback. ISBN: 0-672-21894-1 \$15.95

This is a 6502 assembly-language manual written for the beginning assembly-language programmer on the Apple II. Dr. De Jong introduces each topic in a building-block concept, starting with a description of a microcomputer and continuing through interrupt programming and real-time applications. The book is carefully written and well illustrated with programming examples. The only possible flaw with the book is that it quickly gets technical after the first half dozen chapters. If the reader were truly a beginner, he would find the material difficult.

CONTENTS: The Microcomputer System; Writing and Executing Simple Assembly-Language Programs; Branches and Loops; Logical Operations and Shift and Rotate Operations; Arithmetic Operations; Addressing Modes: Indexed Addressing; Subroutines, The Stack and Interrupts; Additional Programming Topics; Programming with the 6522; Applications; Decimal, Binary, and Hexadecimal Number Systems; Additional Circuits and Programs; Pin Diagrams of Some Integrated Circuits; Index.

Phil Daley
MICRO Staff

Kids and the Apple, by Edward H. Carlson. Reston Publishing Company, Inc. (Reston, VA), 1982, 218 pages, paperback. ISBN: 0-8359-3669-4 \$19.95

This book teaches Applesoft BASIC on both disk-based or cassette Apple systems to children from 10-14 years old. The book is intended for self-study, but may also be used in a classroom setting. The lessons contain explanations, examples, exercises, and review questions. Notes for the instructor summarize the lesson material, provide helpful hints, and give good review questions.

CONTENTS: Introduction; Graphics, Games, and All That; Advanced Programming.



Chances are, when you bought your first disk drive, it was an Apple. Now that you're ready for a second, take a look at Quentin.

Our Apple*-Mate™ 5¼" Disk Drive is fully software transparent with Apple's DOS 3.3 operating system in full and half track operation.

Add it to your present drive for greater capacity and faster access. Just plug it in and go to work.

And the Apple-Mate has these High Performance advantages:

ON TRACK HEAD SEEK

A precision lead screw positions the head onto the correct track. Time-consuming retries and disk-to-disk copying errors are virtually eliminated.

SIEMENS† DISK DRIVE

The apple-beige unit is built around the highly reliable

Siemens system with over 10,000 lifetime hours. Shielded connecting cable also attached.

LONG TERM DEPENDABILITY

MTBF (Mean Time Between Failures)—8,500 power-on hours, and the unit has a one-year warranty.

COUNT ON QUENTIN FOR QUALITY

Quentin Research was building disk systems for the computer industry when Apple was a little bud on the big computer tree. We're known for product reliability and stand behind every system we sell you.

But the best news may be the price—only \$335.00 (40 tracks).

A special introductory offer when you order Apple-Mate directly from us.

So when you're ready to boost the juice on your Apple, add-on the Quentin Apple-Mate.

To order: Check, money order, Visa or Mastercard number. Calif. residents add 6% sales tax. Allow one week delivery.



19355 Business Center Drive
Northridge, California 91324
(213) 701-1006

MORE JUICE FOR YOUR APPLE®

Special
Introductory
Price:
\$335.00



® Apple is a registered trademark of Apple Computer, Inc.
† Siemens is a trademark of Siemens Corporation.
* Apple-Mate is a trademark of Quentin Research, Inc.,
which does not manufacture Apple computers.

SERIOUS CBM® USERS

NEW FROM KILO

“The Serious Solution”

6809 + MICROWARE OS-9* + BASIC09*

Tired of the frustrating limitations of Commodore Basic? Need to get a serious programming language for your Commodore computer? KILO offers The Serious Solution. A 6809 plug in adaptor board including OS-9 Level I Operating System in ROM, Basic09* and 16K RAM expansion. The KILO 6809 adaptor board simply plugs in to your Commodore computer. The switching between 6502 and 6809 is under software control. Expansion RAM can be used to replace protection ROMs with 6502.

With The Serious Solution, all Microware software can now be run on your computer. The standard package comes with the Basic09 Structured Basic Interactive Compiler. The fastest and most comprehensive full Basic language available for the 6809. This combines standard Basic with the best features of PASCAL. It features compiler speed, interpreter friendliness and superlative debugging facilities. Option available includes Run B...a ROMable run-time system for compiled Basic-09.

Please note: The OS-9 distribution disk format is not compatible with the Commodore disk format. OS-9 software purchased from sources other than KILO may need to be reformatted. KILO will provide this service at \$10.00 per disk. Software vendors should contact KILO for SS-50 to Commodore adaptor hardware and software.

SPECIAL: Buy The Serious Solution before Christmas and get Editor/Assem./Debug package for \$200.

The Serious Solution	\$489
including 6809 adaptor board, OS-9 Level I operating system in ROM, Basic09 and 16K RAM expansion.	

Microware* Software Options	
PASCAL compiler	\$400
C Compiler	\$400
CIS COBOL Compiler	\$895
Editor/Assem./Debug package	\$300

VISA and Mastercard welcome. Don't forget last month's KILO ad.

CBM and Commodore are registered trademarks of Commodore Computer, OS-9 and Basic09 are registered trademarks of Microware and Motorola. CIS COBOL is a trademark of Micro Focus, Inc.

KILO CORPORATION • P.O. Box 7530 • Ann Arbor, MI 48107 • 313 668-1566

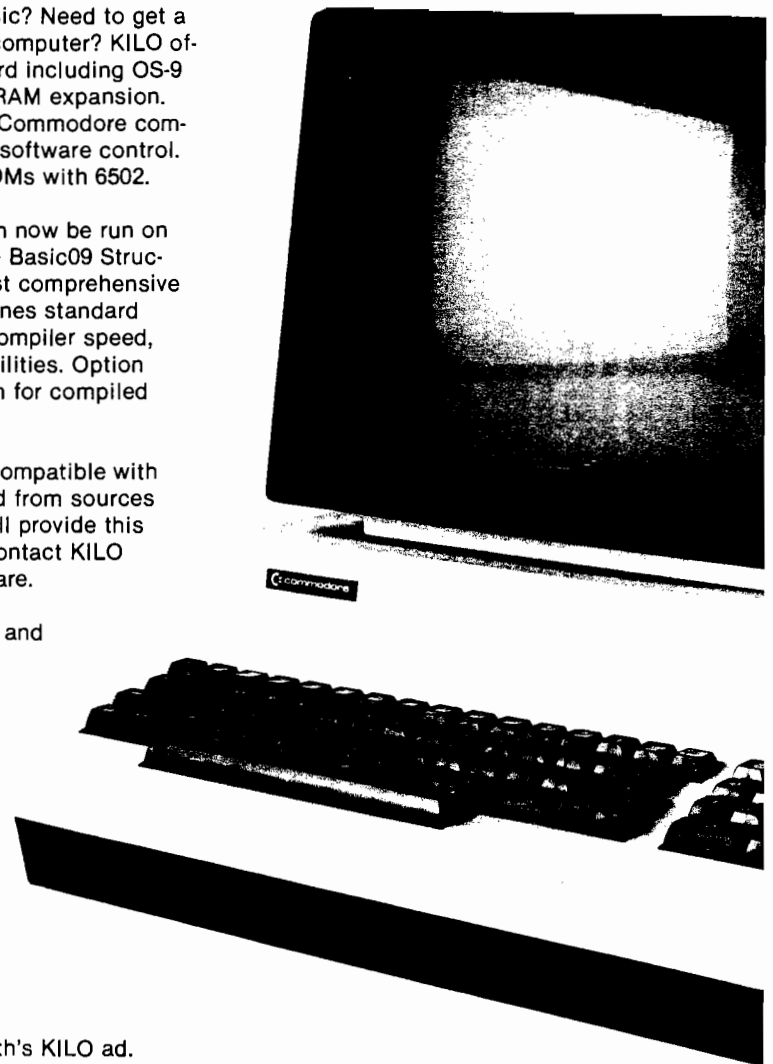

Listing 1: Recursive Procedure In Pseudo-Code

```

PROCEDURE MOVE RECEIVE
(NMDISC, FROM, TO, USING)

IF NMDISC > 0 THEN

CALL MOVE WITH(NMDISC - 1,
FROM, USING, TO)

PRINT FROM, " → ", TO

CALL MOVE WITH(NMDISC - 1,
USING, TO, FROM)

ENDIF

END PROCEDURE

```

The Recursive Assembly-Language Program

In the assembly-language program (listing 2), there are four zero-page locations (lines 130-160) for passing values to the recursive procedure labeled MOVE (lines 530-820). Values are passed from recursive procedural calls via these locations, as well as initially from the calling routine. The calling routine (lines 470-490) jumps to lines 1590-2360 to initialize the parameters and stack pointers. Register Y is used as the stack index, and is initialized to \$FF. When MOVE is called, register Y is incremented before the values passed are actually pushed on the stack, so that the procedure, when first called, will increment register Y to \$00, then push the values on the stack indexed by register Y.

The stack pointers are initialized next. There are four stacks, one stack for each value that is passed. When the procedure is called, register Y is incremented so that it points to a new stack position. The total number of bytes used in each stack for any given game is equal to the number of discs on the tower. Each stack occupies one page (\$00-\$FF) of memory. Actually, the stack size only needs to be one half of a page because the number of JSRs that can be executed, and therefore the number of recursive calls and separate values, is limited by the 6502's one-page stack, which can only hold \$80 two-byte return addresses. The largest tower that this program can move has approximately \$70 discs on it, which allows part of the stack to have been used already by the calling routine. However, having a maximum game of \$70 discs is obviously no problem if it would take a computer a million years just to solve a \$40 (decimal 64) disc game!

After the initialization routine stores zero in the location that holds

Listing 2

```

0010 ;*****
0020 ;#
0030 ;#      FAGOOD SOLVER      #
0040 ;#
0050 ;#      by Sherwood Hoyt   #
0060 ;#
0070 ;*****
0080 ;
0090 ;--- parameters passed ---
0100 ;
0110         .ba $54                ;PET
0120 ;OS-65D--$10; Apple--$+0
0130 nmdisc .de =
0140 from    .de nmdisc+1
0150 to      .de from+1
0160 using   .de to+1
0170 ;
0180 ;--- stack ptr's to local values ---
0190 ;
0200 nptr    .de using+1
0210 fptr    .de nptr+2
0220 tptr    .de fptr+2
0230 uptr    .de tptr+2
0240 ;
0250 ;--- stack location ---
0260 ;
0270         .ba $1800              ;$4000--OS-65D; $800--App1
0280 nstack  .de =
0290 fstack  .de nstack+$100
0300 tstack  .de fstack+$100
0310 ustack  .de tstack+$100
0320 ;
0330 ;--- miscellaneous ---
0340 ;
0350 nmoves  .de uptr+2              ;current number of moves
0360 input   .de $+fcf              ;get character
0370 ;Apple--$+d0c; OS-65D--$2339
0380 output  .de $+fd2              ;output character
0390 ;Apple--$+ded; OS-65D--$2343
0400 return  .de $0d
0410 lf      .de $0a
0420 ;
0430         .ba ustack+$100        ;OS-65D--$317e
0440 ;
0450 ;
0460 ;--- call major subroutines ---
0470 ;
1C08- 20 B8 1C 0480      jsr init          ;init. ptr's & parameters
1C03- 20 09 1C 0490      jsr move          ;call proc. to move tower
1C06- 4C 78 1D 0500      jmp done
0510 ;
0520 ;--- recursive procedure to move tower ---
0530 ;
1C09- 20 A9 1C 0540 move   jsr push          ;push values to stack
1C0C- B1 58 0550         lda (nptr),y      ;get # of discs left
1C0E- F8 2D 0560         beq ret          ;if = 0 then pop procedure
0570 ;
1C10- B1 58 0580         lda (nptr),y      ;get values to be passed
1C12- 85 54 0590         sta #nmdisc       ;
1C14- C6 54 0600         dec #nmdisc       ;dec. # of discs on tower
1C16- B1 5A 0610         lda (fptr),y      ;
1C18- 85 55 0620         sta #from        ;
1C1A- B1 5C 0630         lda (tptr),y      ;
1C1C- 85 57 0640         sta #using       ;store 'to' in 'using'
1C1E- B1 5E 0650         lda (uptr),y      ;
1C20- 85 56 0660         sta #to          ;store 'using' in 'to'
1C22- 20 09 1C 0670      jsr move
0680 ;
1C25- 20 3F 1C 0690      jsr prmove       ;display a move
0700 ;
1C28- B1 58 0710         lda (nptr),y      ;pass values to next proc.
1C2A- 85 54 0720         sta #nmdisc       ;
1C2C- C6 54 0730         dec #nmdisc       ;dec. # of discs on tower
1C2E- B1 5A 0740         lda (fptr),y      ;
1C30- 85 57 0750         sta #using       ;store 'from' in 'using'
1C32- B1 5C 0760         lda (tptr),y      ;
1C34- 85 56 0770         sta #to          ;
1C36- B1 5E 0780         lda (uptr),y      ;
1C38- 85 55 0790         sta #from        ;store 'using' in 'from'
1C3A- 20 09 1C 0800      jsr move          ;do recursive call
0810 ;
1C3D- 88 0820 rst        dey          ;pop procedure from stack
1C3E- 68 0830          rts

```

(continued)

Figure 2: Sample Runs

ENTER TOWER SIZE: 3

```
0001 1 → 3
0002 1 → 2
0003 3 → 2
0004 1 → 3
0005 2 → 1
0006 2 → 3
0007 1 → 3
```

*** DONE ***

ENTER TOWER SIZE: 4

```
0001 1 → 2
0002 1 → 3
0003 2 → 3
0004 1 → 2
0005 3 → 1
0006 3 → 2
0007 1 → 2
0008 1 → 3
0009 2 → 3
000A 2 → 1
000B 3 → 1
000C 2 → 3
000D 1 → 2
000E 1 → 3
000F 2 → 3
```

*** DONE ***

the current number of moves (lines 1830-1850), it stores the initial values for the FROM, USING, and TO pegs (lines 1890-1940). Then in lines 1980-2030 the prompt "ENTER TOWER SIZE:" is displayed, and lines 2080-2360 input the user response. The input routine will only accept a one- or two-digit hexadecimal number. If a one-digit number is entered, the return key must follow it. If two digits are entered, the program will continue execution and no return needs to be entered.

The next call that the calling routine makes, after initialization, is to the recursive procedure; MOVE. The first operation is to push the variables it receives onto the stack. This allows the variables for each successive calling of the procedure to be maintained separately. When the procedure is finished, the stack index will be decremented (line 810), effectively popping the variables off of the stack. The only other thing done with the variables is for the procedure to call itself with the variables (in slightly modified form) as parameters. This the procedure performs twice. Also, between the two recursive calls, the procedure calls PRMOVE from line 860-1030 to display a move. The variables FROM and TO are passed to it. FROM is the peg to

Listing 2 (continued)

```

0840 ;
0850 ;--- print a move ---
0860 ;
1C3F- 20 6D 1C 0870 prmove    jsr prnum          ;print current # of moves
1C42- 81 5A 0880          lda (&ptr),y
1C44- 09 30 0890          ora #30
1C46- 20 D2 FF 0900          jsr output         ;print peg # to take disc
1C49- A2 01 0910          ldx #01           ;print ' -> '
1C4B- B0 67 1C 0920 p1      lda p3,x
1C4E- F0 06 0930          beq p2
1C50- 20 D2 FF 0940          jsr output
1C53- E8 0950          inx
1C54- D0 F5 0960          bne p1
1C56- 81 5C 0970 p2      lda (&ptr),y
1C58- 09 30 0980          ora #30
1C5A- 20 D2 FF 0990          jsr output         ;print peg# to put disc on
1C5D- A9 0D 1000          lda #return      ;new line
1C5F- 20 D2 FF 1010          jsr output
1C62- A9 0A 1020          lda #lf
1C64- 20 D2 FF 1030          jsr output
1C67- 60 1040 p3        rts
1C68- 20 2D 3E 1050          .by ' -> ' @0
1060 ;
1070 ;--- print current number of moves ---
1080 ;
1C6D- E6 60 1090 prnum     inc #nmoves        ;bump # of moves up one
1C6F- D0 02 1100          bne prnum1
1C71- E6 61 1110          inc #nmoves+1
1C73- A5 61 1120 prnum1   lda #nmoves+1
1C75- 4A 1130          lsr a             ;shift high nibble right
1C76- 4A 1140          lsr a
1C77- 4A 1150          lsr a
1C78- 4A 1160          lsr a
1C79- 20 9A 1C 1170          jsr dspbyt       ;display first digit
1C7C- A5 61 1180          lda #nmoves+1
1C7E- 20 9A 1C 1190          jsr dspbyt       ;display second digit
1C81- A5 60 1200          lda #nmoves
1C83- 4A 1210          lsr a             ;shift high nibble right
1C84- 4A 1220          lsr a
1C85- 4A 1230          lsr a
1C86- 4A 1240          lsr a
1C87- 20 9A 1C 1250          jsr dspbyt       ;display third digit
1C8A- A5 60 1260          lda #nmoves
1C8C- 20 9A 1C 1270          jsr dspbyt       ;display fourth digit
1C8F- A9 20 1280          lda #20
1C91- 20 D2 FF 1290          jsr output
1C94- A9 20 1300          lda #20
1C96- 20 D2 FF 1310          jsr output
1C99- 60 1320          rts
1330 ;
1340 ;--- convert byte to ascii and display
1350 ;
1C9A- 29 0F 1360 dspbyt   and #0f           ;clear high nibble
1C9C- 09 30 1370          ora #30
1C9E- C9 3A 1380          cmp #3a
1CA0- 90 03 1390          bcc dspl1
1CA2- 18 1400          clc
1CA3- 69 07 1410          adc #07
1CA5- 20 D2 FF 1420 dspb1  jsr output
1CA8- 60 1430          rts
1440 ;
1450 ;--- push procedure values on stacks ---
1460 ;
1CA9- C8 1470 push      iny             ;bump index for new values
1CAA- A5 54 1480          lda #nmdisc     ;push # of discs to stack
1CAC- 91 58 1490          sta (nptr),y
1CAE- A5 55 1500          lda #from
1CB0- 91 5A 1510          sta (&ptr),y   ;push 'from' peg to stack
1CB2- A5 56 1520          lda #to
1CB4- 91 5C 1530          sta (&ptr),y   ;push 'to' peg to stack
1CB6- A5 57 1540          lda #using
1CB8- 91 5E 1550          sta (&ptr),y   ;push 'using' peg to stack
1CBA- 60 1560          rts
1570 ;
1580 ;--- initialize stack ptr's ---
1590 ;
1CBB- A0 FF 1600 init     ldy #fff         ;set stack index
1610          ;gets bumped to 0 for 1st values
1CBB- A9 00 1620          lda #l,nstack ;set 'nmdisc' stack ptr.
1CBF- 85 58 1630          sta #nptr
1CC1- A9 18 1640          lda #h,nstack
1CC3- 85 59 1650          sta #nptr+1
1660 ;
1CC5- A9 00 1670          lda #l,fstack ;set 'from' stack ptr.
1CC7- 85 5A 1680          sta #fptr
1CC9- A9 19 1690          lda #h,fstack
1CCB- 85 5B 1700          sta #fptr+1
1710 ;
1CCD- A9 00 1720          lda #l,tstack ;set 'to' stack ptr.
1CCF- 85 5C 1730          sta #tptr
1CD1- A9 1A 1740          lda #h,tstack
1CD3- 85 5D 1750          sta #tptr+1
1760 ;
1CD5- A9 00 1770          lda #l,ustack ;set 'using' stack ptr.
1CD7- 85 5E 1780          sta #uptr
1CD9- A9 1B 1790          lda #h,ustack
1CDB- 85 5F 1800          sta #uptr+1
1810 ;
1820 ;--- set number of moves to zero ---
1830 ;

```

(continued)

Listing 2 (continued)

```

1CDD- A9 00      1840      lda #00
1CDF- 85 60      1850      sta #moves
1CE1- 85 61      1860      sta #moves+1
                1870 ;
                1880 ;--- initialize beginning parameters ---
                1890 ;
1CE3- A9 01      1900      lda #01
1CE5- 85 55      1910      sta #from          ;set 'from' to peg #1
1CE7- A9 03      1920      lda #03
1CE9- 85 56      1930      sta #to          ;set 'to' to peg #3
1CEB- A9 02      1940      lda #02
1CED- 85 57      1950      sta #using       ;set 'using' to peg #2
                1960 ;
                1970 ;--- display prompt ---
                1980 ;
1CEF- A2 00      1990 prompt   ldx #00
1CF1- 8D FC 1C   2000      lda pro3,x
1CF4- F0 1C      2010      beq enter
1CF6- 20 D2 FF   2020      jsr output
1CF9- E9         2030      inx
1CFA- D0 F5      2040      bne prompt+2
1CFC- 0A 0A 0D   2050 pro3    .by lf lf return 'ENTER TOWER SIZE: ' 00
1CFF- 45 4E 54
1D02- 45 52 20
1D05- 54 4F 57
1D08- 45 52 20
1D0B- 53 49 5A
1D0E- 45 3A 20
1D11- 00

                2060 ;
                2070 ;--- input number of discs on tower ---
                2080 ;
1D12- 20 CF FF   2090 enter    jsr input
1D15- C9 0D      2100      cmp #return
1D17- F0 2B      2110      beq ent3          ;done inputting
1D19- 20 54 1D   2120      jsr chno
1D1C- 80 F4      2130      bcs enter        ;not a hex digit
1D1E- 20 D2 FF   2140      jsr output       ;display valid digit
1D21- 20 66 1D   2150      jsr strip        ;strip ascii from digit
1D24- 85 54      2160      sta #nmdisc      ;store first digit
1D26- 20 CF FF   2170 ent2    jsr input
1D29- C9 0D      2180      cmp #return
1D2B- F0 17      2190      beq ent3          ;done inputting
1D2D- 20 54 1D   2200      jsr chno
1D30- 80 F4      2210      bcs ent2        ;not a hex digit
1D32- 20 D2 FF   2220      jsr output       ;display valid digit
1D35- 20 66 1D   2230      jsr strip        ;strip ascii from digit
1D38- 06 54      2240      asl #nmdisc     ;shift 1st digit left
1D3A- 06 54      2250      asl #nmdisc
1D3C- 06 54      2260      asl #nmdisc
1D3E- 06 54      2270      asl #nmdisc
1D40- 05 54      2280      ora #nmdisc
1D42- 85 54      2290      sta #nmdisc
1D44- A9 0A      2300 ent3    lda #lf
1D46- 20 D2 FF   2310      jsr output
1D49- A9 0A      2320      lda #lf
1D4B- 20 D2 FF   2330      jsr output
1D4E- A9 0D      2340      lda #return
1D50- 20 D2 FF   2350      jsr output
1D53- 60         2360      rts
                2370 ;
                2380 ;--- check for valid hex number ---
                2390 ;
1D54- C9 30      2400 chno    cmp #'0
1D56- 90 0C      2410      bcc invalid
1D58- C9 3A      2420      cmp #'1
1D5A- 90 09      2430      bcc valid
1D5C- C9 41      2440      cmp #'A
1D5E- 90 04      2450      bcc invalid
1D60- C9 47      2460      cmp #'0
1D62- 90 01      2470      bcc valid
1D64- 38         2480 invalid  sec
1D65- 60         2490 valid    rts
                2500 ;
                2510 ;strip ascii from input
                2520 ;
1D66- C9 41      2530 strip    cmp #'A
1D68- 90 03      2540      bcc st3
1D6A- 18         2550      clc
1D6B- 69 09      2560      adc #09
1D6D- 29 0F      2570 st3    and #0F
1D6F- 60         2580      rts
                2590 ;
                2600 ;--- finished moving tower ---
                2610 ;
1D70- A2 01      2620 done    ldx #01
1D72- 8D 7D 1D   2630      lda do3,x
1D75- F0 06      2640      beq do3
1D77- 20 D2 FF   2650      jsr output
1D7A- E8         2660      inx
1D7B- D0 F5      2670      bne done+2
1D7D- 60         2680 do3    rts
                2690 ;
                2700 ;return to operating system
1D7E- 0A 0A 0D   2700      .by lf lf return '*** DONE *** lf return 00
1D81- 2A 2A 2A
1D84- 20 44 4F
1D87- 4E 45 20
1D8A- 2A 2A 2A
1D8D- 0A 0D 00

                2710 ;
                2720      .en

```

take the disc from, and TO is the peg to put the disc onto.

Trial Run

In figure 2 there are two trial runs. The first one solves the puzzle for three discs and the second for four discs. Remember, the number of discs that you enter at the prompt 'ENTER TOWER SIZE:' is assumed to be a hexadecimal number. A carriage return is required if the number entered has only one digit. (Ed. Note: The routine is written to echo the character received to the screen. If your machine's INPUT routine does this automatically, the character will appear twice on the screen. You may want to skip the echoes in lines 2130 and 2210.) A four-digit hexadecimal number in the first column of output shows the number of moves. This number will turn over to '0000' after it reaches 'FFFF'. The number in the second column tells which peg to take the disc off of and the number in the fourth column tells which peg to put the disc onto.

The author may be contacted at Rt. 1, Box 56, Sand Springs, OK 74063.

MICRO

Scotch®
MEMOREX
Verbatim
maxell
BASF
wabash

Diskettes and all your media needs
 Our *REGULAR* prices are *SPECIAL*

CALL FREE (800) 421-3957

C.O.D. charge cards accepted.
 Excellent dealer program.

Softel

1418 West Shaw Avenue
 Fresno, CA 93711

In Cal call (209) 221-1118

Foothill of The Sierras

Lyc0 Computer Marketing & Consultants

TO ORDER
CALL US

TOLL FREE 800-233-8760
In PA 1-717-398-4079

November 810 Disk Drive \$429.00
ATARI 32K RAM \$ 79.00
SPECIALS 400 16K \$255.00
800 48K \$639.00

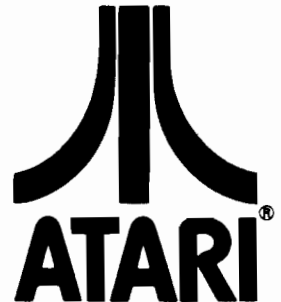

A Warner Communications Company

PERCOM : In Stock

Single Drive CALL
Dual Drive CALL
(Read all Atari Disks)

PRINTERS : In Stock

Epson Mx 80 \$449.00
Epson Mx 80 FT III \$499.00
Okidata 82A \$479.00
Okidata 83A \$719.00
Okidata 84 \$1089.00
Citoh CALL
NEC CALL
(Interfacing Available)

JOYSTICKS : In Stock

Atari CX-40 \$18.00
LeStick \$34.00
Wico Command Control \$24.00

Computer Covers :

800 \$6.99
400 \$6.99
810 \$6.99

DISKETTES : In Stock

Maxell MD1 . . .(10) \$34.00
Maxell MD2 . . .(10) \$44.00
Elephant . . .(10) \$21.00

THIRD PARTY SOFTWARE ATARI PROGRAM EXCHANGE

Eastern Front 1941 \$25.50
Avalanche \$15.50
Outlaw/Howitzer \$15.50
Dog Daze \$15.50
Wizard of War \$31.00
Gorf \$31.00
Frogger \$26.00

BUSINESS SOFTWARE : In Stock

Atari Word Processing \$109.00
Letter Perfect \$129.00
Test Wizzard \$ 89.00
Datsam/65 \$125.00
Interisp \$125.00

Monkey Wrench \$ 42.00

ATARI HARDWARE

410 Cassette Recorder \$75.00
825 Printer \$585.00
830 Phone Modem \$149.00
850 Interface \$164.00

PACKAGES

CX481 Entertainer \$69.00
CX482 Educator \$125.00
CX483 Programmer \$49.00
CX494 Communicator \$325.00

SOFTWARE

CXL4013 ASTEROIDS \$28.75
CXL4004 BASKETBALL \$28.75
CX4105 BLACKJACK \$12.75
CXL4009 COMPUTER CHESS \$28.75
CXL4012 MISSILE COMMAND \$28.75
CXL4011 STAR RAIDERS \$35.00
CXL4006 SUPER BREAKOUT \$28.75
CXL4010 3-D TIC-TAC-TOE \$28.75
CXL4005 VIDEO EASEL \$26.00
CXL4008 SPACE INVADERS \$28.75
CX8130 CAVERNS OF MARS \$31.75
CXL4020 PAC MAN \$32.75
(NEW) CENTIPEDE \$32.75
CX4121 ENERGY CZAR \$12.75
CX4108 HANGMAN \$12.75
CX4102 KINGDOM \$12.75
CX4112 STATES & CAPITALS \$12.75
CX4114 EUROPEAN COUNTRIES \$12.75

CX4101 PROGRAMMING I \$19.95
CX4106 PROGRAMMING II \$22.75
CX4117 PROGRAMMING III \$22.75
CXL4007 MUSIC COMPOSER \$33.75
CX8102 CALCULATOR \$28.75
CX4109 GRAPH IT \$16.75
CXL4003 Assembler Editor \$45.00
CX8121 Macro Assembler \$69.00
CXL4002 Atari Basic \$45.00
CX8126 Microsoft Basic \$65.00
CXL4018 Pilot Home \$65.00
CX405 PILOT EDUCATOR \$99.00
CXL4015 TELELINK \$21.00
CX4123 SCRAM \$19.75
CX4107 Biorhythm \$13.00
CX4119 French \$45.00
CX4118 German \$45.00
CX4120 Spanish \$45.00
CX4125 Italian \$45.00



THIRD PARTY SOFTWARE

for atari 800 or 400
K-BYTE

KRAZY SHOOTOUT \$35.00
K-DOS \$65.00
K-STAR PATROL \$37.75
K-RAZY ANTICS \$37.75
K-RAZY KRITTERS \$37.75
Q-BALL JOYSTICK KIT \$6.75

AUTOMATED SIMULATIONS

Star Warrior \$28.00
Crush, Crumble & Chomp \$23.00

WE CARRY MANY OTHER THIRD PARTY PRODUCTS
YOU CAN CALL FOR PRICES ON AND ASK FOR
YOUR FREE ATARI PRODUCT CATALOG.

commodore

VIC-20 \$189.00

VIC1530 DATASSETTE \$67.00
VIC1540 DISK DRIVE \$499.00
VIC1515 PRINTER \$355.00
VIC1210 3K RAM \$35.00
VIC1110 8K RAM \$52.00
VIC1211A SUPER EXPANDER \$53.00

VIC-20 SOFTWARE

VIC1212 PROGRAMMER AID \$45.00
VIC1213 VICMON \$45.00
VIC1906 SUPER ALIEN \$23.00
VIC1914 ADVENTURE
LAND ADVENTURE \$35.00
VIC1915 PRIVATE COVE
ADVENTURE \$35.00
VIC1916 MISSION IMPOSSIBLE \$35.00
VIC1917 THE COUNT ADVENTURE \$35.00
VIC1919 SARGON II CHESS \$35.00

THIRD PARTY SOFTWARE

ALIEN BLITZ \$21.00
Omega Race \$35.00
Gorf \$32.00
16K RAM/ROM \$99.00
AMOK \$21.00
SUPER HANGMAN \$16.00
SPIDERS OF MARS \$45.00

POLICY

Pre-paid orders receive free shipping in the continental U.S.
Personal checks require four weeks clearance before shipping
In-Stock items shipped within 24 hours of order
Back-Ordered and Out-of-Stock items shipped as soon as they are available
Cancellation of Back-Order and Out-of-Stock items prior to shipping receive
full refund or credit towards another purchase upon request.
All products subject to availability and price change.

TO ORDER
CALL TOLL FREE
800-233-8760

In PA 1-717-398-4079

or send order to

Lyc0 Computer
P.O. Box 5088
Jersey Shore, PA 17740

VIC/PET GOMOKU

by David Malmberg

A fast, machine-language version of the popular oriental game, with three user-selectable styles for the computer's play.

GOMOKU

requires:

VIC with 3K or more extra RAM and joystick or PET with 8K or more

GOMOKU is an ancient oriental game of strategy. According to Edward Lasker's book *Go and GOMOKU* (Dover, 1960), GO means "five" and MOKU means "stones." To play, you and your opponent alternate placing stones on the intersections of the lines of a square grid. One person plays with white stones and the other uses black stones. As the name implies, the object of the game is to have your stones occupy five adjacent points on a grid — vertically, horizontally, or diagonally — before your opponent gets five of his stones in a row. You must get exactly five in a row to win. Connecting two chains of stones less than five long to form a chain greater than five stones long will not win the game.

The most obvious way a player can force a win is to create a situation where he has four stones in a row with both ends of the chain open for potential stones. The opponent will be able to block only one end of the chain, so the player can win by placing a stone at the other end. To reach a forced win with an "open-four," the player must first create an "open-three." Whenever a player threatens a win by making an open-three, the opponent must immediately play a stone at one end of this chain of three in order to avoid losing the game two moves later.

As GOMOKU is played in both Japan and China, only one type of move is illegal: a participant cannot play a stone that creates more than one open-three simultaneously. The oriental

originators of GOMOKU felt that the game would not be enough of a challenge if this type of easy win were permitted.

VIC/PET GOMOKU

The computerized version of GOMOKU allows the enforcement of the no-multiple open-threes rule to be op-

tional. However, remember that if you elect to play without this restriction, the computer will play accordingly.

VIC/PET GOMOKU plays an excellent game. Its main counting and evaluation routines are written in machine language for increased speed and enhanced logic. The program takes 10 to 30 seconds between moves, depending on the density of stones on the

Listing 1

```

1 RL=22:S=256*PEEK(648)-1:A=30720:IFPEEK(648)=16THENA=33792
2 FH=RND(-TI):POKE36879,25:DD=37154:P1=37151:P2=37152:V=36878:E=36876
3 FORI=1TO8:READX:POKE951+I,X:NEXTI:DATA1,21,22,23,129,149,150,151:FH=10
4 ML=PEEK(43)+256*PEEK(44)+3839:B=ML/256:DIMD(8),V%(14,14)
5 FORI=1TO13:READX:POKEML+X,B:NEXT
6 DATA2,22,51,54,75,91,104,125,136,161,170,215,256
7 B=B+1:FORI=1TO4:READX:POKEML+X,B:NEXT:DATA19,306,351,384
8 MV$="XXXXXXXXXXXXXXXXXXXX":WH$="XXXXXXXXXXXXXXXXXXXX"
9 FORI=1TO8:READ(I):NEXT:DATA-22,-21,1,23,22,21,-1,-23
10 H=87:C=81:NP$="C":M=0:W=0:PRINT" MICRO GOMOKU":IN$="N"
11 PRINT" BY DAVID MALMBERG"
12 PRINT" WANT TO MOVE FIRST ";:GOSUB85:PRINT
13 ILEFT*(IN$,1)="Y"THENNP$="H"
14 IN$="W":PRINT" WHITE OR BLACK ";:GOSUB85:PRINT:IFIN$="B"THENH=81:C=87
15 POKE950,C:POKE951,H:IN$="2":PRINT" HOW SHOULD I PLAY?":PRINT 1: CAUTIOUS"
16 PRINT" 2: BALANCED" :PRINT" 3: AGGRESSIVE ";
17 GOSUB85:PRINT:X=VAL(LEFT*(IN$,1))
18 IFX>3ORX<1THENPRINT:PRINT" 1,2, OR 3 ONLY ";:GOTO17
19 ZZ=0:PRINT" PLAY OPEN 3'S RULE ";:GOSUB85:PRINT:IFIN$<"Y"THENZZ=1
20 FC=6+2*X:N=8:G=7:MT=14*14:FORI=1TO14:FORJ=1TO14:V%(I,J)=0:NEXTJ:NEXTI:O=1
21 PRINTCHR$(28)" MICRO GOMOKU"
22 PRINTTAB(0+2)" ABCDEFGHIJKLMNOP " :PRINTTAB(0)" 1 " :FORI=2TO13
23 PRINTTAB(0-1)RIGHT*(STR$(I),2)" " :PRINTTAB(0+3)" "Y MOVE:"
24 NEXTI:PRINTTAB(0-1)" 14 " :PRINTTAB(0+3)" "Y MOVE:"
25 PRINTCHR$(144);WH$:CHR$(128+H);" " :CHR$(128+C)
26 IFNP$<"H"THEN31
27 PRINTCHR$(30);WH$;" YOU " :T=H:POKEV,15:FORK=195TO240:U=TI
28 POKEE,K:IFTI<U+1THEN28
29 NEXT:POKEE,0:GOSUB96:M=M+1:V%(I,J)=-30000:MT=MT-1:IFW=HTHEN76
30 IFMT=0THEN75
31 PRINTCHR$(30);WH$;" YOU " :IFM=0THENI=7:J=8:GOTO36
32 QM=C:GOSUB46:MX=-1E15:FORMI=1TO14:FORMJ=1TO14:IFV%(MI,MJ)<MXTHEN35
33 IFV%(MI,MJ)=MXANDRND(1)>.2THEN35
34 XJ=MJ+0+2:XI=MI+4:L=S+RL*(XI-1)+XJ:MX=V%(MI,MJ):I=MI:J=MJ
35 NEXTMJ:NEXTMI
36 B$="":IFI<10THENB$=" "
37 PRINTCHR$(28);MV$TAB(0+12);B$:CHR$(J+64)MID*(STR$(I),2);N=I:G=J:CL=J+0+2
38 R=I+4:L=S+RL*(R-1)+CL
39 P=PEEK(L):POKEV,15:FORK=1TO6:POKEL,P:U=TI:POKEE,135
40 IFTI<U+8THEN40
41 POKEL,C:POKEL+R,0:U=TI:POKEE,240
42 IFTI<U+8THEN42
43 NEXTK:POKEV,0:POKEE,0:T=C:GOSUB68:MT=MT-1:IFW=CTHEN76
44 IFMT=0THEN75
45 QM=H:GOSUB46:V%(I,J)=-30000:GOTO27
46 II=I:JJ=J:POKE991,QM:FORIN=-1TO1:FORJN=-1TO1:IFIN=0ANDJN=0THENNEXTJN
47 FORKN=1TO4:I=II+KN*IN:J=JJ+KN*JN:IFI<1ORJ>14THENKN=4:GOTO67
48 IFJ<1ORJ>14THENKN=4:GOTO67
49 CL=J+0+2:R=I+4:L=S+RL*(R-1)+CL:P=PEEK(L):IFP=CORP=HTHEN67
50 POKEL,P+128:V%(I,J)=0:LH=INT(L/256):LL=L-LH*256:POKE962,LL:POKE963,LH
51 POKEL,P:SYS(ML):ZP=PEEK(973):IFZP=0THEN55
52 FORY=1TO2P:NC=PEEK(974+Y):NH=PEEK(982+Y):F=FH:IFNH=0THENNH=NC:F=FC
53 V%(I,J)=V%(I,J)+INT(F*NH*NH):NEXTY:NE=PEEK(993)
54 IFNE<0THENV%(I,J)=V%(I,J)-NE*NE
55 NH=0:IFPEEK(992)=0THEN67
56 FORY=1TO4:O=0:Z=D(Y):T=PEEK(L+Z):IFT<PEEK(L-Z)THEN66
57 IFT=HORT=CTHEN59
58 GOTO66

```

(continued)

Listing 1 (continued)

```

59 Z=D(Y):GOSUB91:IFPEEK(L)<>TTHENQ=Q-1
60 IFQ>4THENQ=0:GOTO66
61 IFQ<4THENQ=4
62 IFT=CTHENQ=2
63 Q=Q+1:GOTO66
64 IF(N1=HORN1=C)ANDN1=N2THENQ=0
65 IFQ=3AND(N1<>HANDN1<>C)AND(N2<>HANDN2<>C)THENQ=8
66 NH=NH+Q:NEXTY:IFNH>0THENV%(I,J)=INT(FH*NH*NH)+V%(I,J)
67 NEXTKN:NEXTJN:NEXTIN:I=II:J=JJ:RETURN
68 N3=0:FORY=1TO4:Z=D(Y):GOSUB91
69 IFQ=3THENIFN1<>CANDN1<>32ANDN2<>32THENN3=N3+1
70 IFQ=5THENW=T:GOTO72
71 NEXTY
72 IFQ=5ANDW=HTHENFH=H*1.2
73 IFZZTHENN3=0
74 RETURN
75 PRINTMV*"*STALEMATE":GOTO83
76 IFN#="C"ANDW=CTHENM=M+1
77 IFW=HTHENPRINTMV*"*YOU WON IN""M" MOVES"
78 IFW=CTHENPRINTMV*"*I WON IN""M" MOVES"
79 IFM<10THENPRINT"GOOD GAME!"
80 IFM>9ANDM<20THENPRINT"CLOSE GAME!"
81 IFM>19ANDM<30THENPRINT"GREAT GAME!"
82 IFM>29THENPRINT"FANTASTIC GAME!"
83 PRINT"WANT TO PLAY AGAIN":GOSUB85:IFLEFT$(IN$,1)="Y"THEN10
84 END
85 ZC=1:ZT=0
86 GETZ$:IFZ$<>" "THEN89
87 IFT1=ZTTHENPRINTMID$(Z$,ZC,1);"";:ZT=TI+30:ZC=ZC-20
88 GOTO86
89 IFZ$<>CHR$(13)THENIN$=Z$
90 PRINT"? ";IN$:RETURN
91 Q=1:LN=L+Z
92 IFPEEK(LN)=TTHENQ=Q+1:LN=LN+Z:GOTO92
93 N1=PEEK(LN):LN=L-Z
94 IFPEEK(LN)=TTHENQ=Q+1:LN=LN-Z:GOTO94
95 N2=PEEK(LN):RETURN
96 XJ=G+Q+2:XI=N+4:L=S+RL*(XI-1)+XJ:P=PEEK(L):FS=T:IFFS=PTHENFS=128+FS
97 POKEL,FS:FZ=P:ZT=TI+9
98 POKEE,0:DX=0:DY=0:FB=0:GOSUB112:IFDXORDYORFBTHEN10
99 IFT1<ZTTHEN98
100 Z=FZ:FZ=PEEK(L):POKEL,Z:ZT=TI+9:GOTO98
101 IFFBTHEN109
102 POKEL,P:N=N+DY:G=G+DX:POKEE,135:U=TI
103 IFT1<U+9THEN103
104 IFN>14THENN=1
105 IFN<14THENN=14
106 IFG>14THENG=1
107 IFG<14THENG=14
108 GOTO96
109 IFP=CORP=HTHEN98
110 GOSUB68:IFN3>1THEN98
111 POKEL,T:POKEL+A,0:POKEV,0:POKEE,0:I=N:J=G:RETURN
112 POKEDD,127:B=PEEK(P2)AND128:J0=-<(B=0):POKEDD,255:B=PEEK(P1)
113 J2=-<(BAND16)=0):J3=-<(BAND4)=0):FB=-<(BAND32)=0):J1=-<(BAND8)=0)
114 IFJ0THENDX=1
115 IFJ1THENDY=1
116 IFJ2THENDX=-1
117 IFJ3THENDY=-1
118 RETURN
READY.

```

grid. By comparison, the first version of GOMOKU I wrote was entirely in BASIC and took from three to six minutes between moves — and it did not play half as well as the current version. VIC/PET GOMOKU should be capable of holding its own against even very good human players — especially if the computer moves first.

VIC/PET GOMOKU has three styles of play: cautious, balanced, and aggressive. These styles refer to how much the computer will weigh defensive vs. offensive moves in its evaluation of the merits of its next move. If you select a balanced style, both offense and defense have equal weights. You will find the computer will win more games when it is playing aggressively. However, when you select the cautious style for the computer, you may not be able to win often because many games will end up in stalemate;

the computer will unrelentingly block your chances for any kind of a winning pattern. When the computer loses a game, it will automatically play a more aggressive game the next time.

The VIC Version

The VIC version of GOMOKU needs at least 3K of additional memory. This can be obtained by using any of the standard VIC Super Expander, 3K, 8K, or 16K memory cartridges.

The program is written in two parts. Listing 1, the main part, is written in BASIC and should be keyed-in exactly as shown in the listing (i.e., with no unnecessary spaces to conserve memory). Listing 2, a hex-dump of the machine-language routines, shows the machine code being located from \$1300 to \$14AB. These locations assume you are using either the Super Expander or the 3K memory cartridges, which cause

the start of BASIC to be located at \$0400 (just like the PET). If you are using either the 8K or 16K memory expanders, this machine code should be located from \$2100 to \$22AB because the start of BASIC is relocated to \$1200 by the VIC's operating system. When you use a monitor to enter and save the code in the hex listing, there is no need to worry about relocating the two-byte addresses since lines 4-6 of the BASIC program automatically adjust them to correspond to the memory configuration of your VIC.

To create a working copy of GOMOKU for the VIC, first load the BASIC portion (listing 1). Then load the machine-language code you had previously saved with the monitor by

Listing 2

```

.:1300 20 ED 13 A9 00 85 5C 85
.:1308 50 85 48 85 49 A5 48 85
.:1310 42 20 02 14 20 40 13 A5
.:1318 44 C9 00 F0 0C A6 49 A5
.:1320 3C 95 4B A5 3D 95 53 E6
.:1328 49 A5 48 C9 07 F0 05 E6
.:1330 48 4C 0D 13 20 38 13 60
.:1338 A2 00 B5 32 9D B6 03 B0
.:1340 84 03 95 32 E0 28 F0 04
.:1348 E8 4C 3A 13 60 A5 3C C9
.:1350 03 F0 09 A5 3D C9 03 F0
.:1358 10 4C 89 13 A5 45 C5 33
.:1360 D0 07 A9 00 85 3D 4C C5
.:1368 13 A5 45 C5 33 F0 1A C5
.:1370 32 F0 16 A5 5B C5 4A D0
.:1378 05 A9 0A 4C 80 13 A9 08
.:1380 85 3C A9 00 85 3D 4C C5
.:1388 13 A5 3C C9 04 D0 1C A5
.:1390 46 C5 32 F0 0D A5 47 C5
.:1398 32 F0 07 A9 0D 85 3C 4C
.:13A0 C5 13 A9 00 85 3C 85 3D
.:13A8 4C C5 13 A5 3D C9 04 D0
.:13B0 14 A5 46 C5 33 F0 EB A5
.:13B8 47 C5 33 F0 E5 A9 08 85
.:13C0 3C A9 00 85 3D A9 00 85
.:13C8 44 A5 3C C9 0D 00 09 A5
.:13D0 3D C9 00 D0 09 4C E2 13
.:13D8 A5 3D C9 0D 00 04 A9 01
.:13E0 85 44 A5 4A C5 47 D0 04
.:13E8 A9 01 85 5C 60 A2 00 85
.:13F0 32 9D 84 03 B0 86 03 95
.:13F8 32 E0 28 F0 04 E8 4C EF
.:1400 13 60 A5 3E 85 40 A5 3F
.:1408 85 41 A6 42 B5 34 85 43
.:1410 A2 00 86 3C 86 3D 86 45
.:1418 86 46 86 47 86 4A A5 43
.:1420 38 C9 80 80 0E A5 40 38
.:1428 E5 43 B0 02 C6 41 85 40
.:1430 4C 3E 14 E9 80 18 65 40
.:1438 90 02 E6 41 85 40 A0 00
.:1440 B1 40 85 47 A5 3E 85 40
.:1448 A5 3F 85 41 E8 A5 43 38
.:1450 C9 80 80 0C 18 65 40 90
.:1458 02 E6 41 85 40 4C 6F 14
.:1460 E9 80 85 44 A5 40 38 E5
.:1468 44 B0 02 C6 41 85 40 A0
.:1470 00 B1 40 C9 20 D0 0A 38
.:1478 E0 03 B0 2F E6 5D 4C AB
.:1480 14 C5 32 D0 02 E6 3C C5
.:1488 33 D0 02 E6 3D E0 01 D0
.:1490 02 85 4A E0 04 D0 02 85
.:1498 45 E0 05 D0 AF 85 46 C5
.:14A0 32 D0 02 C6 3C C5 33 D0
.:14A8 02 C6 3D 60 AA AA AA AA

```

using the command LOAD "name", 1,1. The 1's at the end of the LOAD will load the code at its absolute location (i.e., \$1300-\$14AB or \$2100-\$22AB), rather than automatically being relocated to the start of BASIC. After both parts have been loaded, issue the command SAVE "VIC GOMOKU" and you will save a copy that combines both parts and can be used independently of whatever memory configuration is operating in the VIC.

The VIC version of GOMOKU uses the joystick to indicate your move. Once you have moved the cursor to your desired location, just hit the fire-button.

The PET Version

The machine-language code in the hex-dump (listing 2) will work without any changes in the PET. However, several lines of the BASIC program must be changed. Specifically, listing 3 contains all the lines that must be changed in listing 1 to get GOMOKU to work on the PET. In addition to these differences, lines 7, 116, 117, and 118 of listing 1 should not be included in the PET version. The BASIC instructions should be typed without any unnecessary spaces to assure that the BASIC part does not run into the

Listing 3

```

1 RL=40:S=32767:E=12*4096:V=E:A=5*4096
2 FH=RND(-TI)
3 FORI=1TO8:READX:POKE951+I,X:NEXTI:DATA1,39,40,41,129,167,168,169:FH=10
4 ML=PEEK(40)+256*PEEK(41)+3839:DIMD(8),VZ(14,14),DR(9),DC(9)
5 FORI=1TO9:READDR(I),DC(I):NEXTI
6 DATA1,-1,1,0,1,1,0,-1,0,0,1,-1,-1,-1,0,-1,1
9 FORI=1TO8:READDI(I):NEXI:DATA-40,-39,1,41,40,39,-1,-41
10 H=81:C=87:NP$="C":M=0:W=0:PRINT"MICRO GOMOKU":IN$="N"
14 IN$="W":PRINT"WHITE OR BLACK ";:GOSUB85:PRINT:IFIN$="B"THENH=87:C=81
112 GETF$:IFF$=""THENRETURN
113 IFF$=CHR$(13)THENFB=1:RETURN
114 IFF$<"1"ORF$>"9"THENRETURN
115 QQ=ASC(F$)-48:DX=DC(QQ):DY=DR(QQ):RETURN
    
```

machine-code part. If you have an 80-column screen, change RL in line 1 to 80, the DATA values in line 3 to 1, 79, 80, 81, 129, 207, 208, 209, and the DATA values in line 9 to -80, -79, 1, 81, 80, 79, -1, -81.

To create a working PET copy of GOMOKU, first load the BASIC part, then load the machine code previously saved by the monitor (it will always be located from \$1300 to \$14AB in the PET version), then issue the command SAVE "PET GOMOKU" to save a copy that combines both parts.

The PET version uses the numeric keyboard to indicate your move. Once the cursor is where you wish to move, just hit RETURN to enter the move.

Acknowledgement

I published an earlier version of PET GOMOKU in the December, 1979 issue of CURSOR (Box 550, Goleta, CA 93116). That version benefitted from many improvements suggested by Glen Fisher. To the extent that his suggestions survived to the current VIC/PET version, his help is gratefully acknowledged.

The text for this article was submitted by the author as a WordPro file. The edited file was then transmitted to our Compugraphic through our FOCUS CompuPlus system.



SIGNALMAN MARK I DIRECT CONNECT MODEM - \$89.50

Standard 300-baud, full duplex, answer/originate. Powered by long lasting 9-volt battery (not included). Cable and RS-232 connector included.

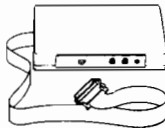

EPROMS - HIGH QUALITY, NOT JUNK

Use with PET, APPLE, ATARI, SYM, AIM, etc. 450 ns. \$6.50 for 2716, \$12.50 for 2532. We sell EPROM programmers for PET and ATARI

5 1/4 INCH SOFT SECTORED DISKETTES

Highest quality. We use them on our PETs, APPLES, ATARIs, and other computers. \$22.50/10 or \$44.50/20



NEW! C. ITOH STARWRITER F-10 DAISY WHEEL PRINTER

Letter quality, flawless copy at 40 char/sec. Bidirectional printing, 15-inch carriage, uses standard Diablo ribbons and print wheels. ~~IEEE = \$1595~~

PARALLEL - \$1495, RS-232 - \$1680, TRACTORS - \$210

MAE SOFTWARE DEVELOPMENT SYSTEM FOR PET, APPLE, ATARI

"The Compatible Assembler"

- Professional system for development of Machine Language Programs. 31 Characters per label.
- Macro Assembler/Text Editor for Disk-based systems.
- Includes Word Processor for preparation of Manuals, etc.
- Standard Mnemonics - Ex.: LDA (LABEL), Y
- Conditional Assembly, Interactive Assembly.
- Editor has string search/search and replace, auto line numbering, move, copy, delete, ul/c capability.
- Relocating Loader to relocate object modules.
- Designed with Human Factors Considerations.

\$169.95

FLASH!! EHS Management has decided to allow \$50.00 credit to ASM/TED owners who want to upgrade to MAE. To get this credit, return ASM/TED manual with order for MAE

ATARI AND PET EPROM PROGRAMMER

Programs 2716 and 2532 EPROMs. Includes hardware and software. PET = \$75.00 - ATARI (includes sophisticated machine language monitor) = \$119.95



PET BASIC SCROLL PROGRAM

Scroll thru basic program using Cursor up/down keys. Specify computer. \$6.00 on cassette, \$9.00 on disk.

Flip 'N' File diskette storage case (50-60 disks) - \$21.95

Memory Test for Apple on Disk = \$9.95, on Tape = \$6.95

System Saver for Apple - Fan, Surge Protection, 2 extra outlets, Apple power cord = \$75.00

BMC Green Screen Video Monitor. 12 inch CRT, sharp, crisp 40 or 80 column display. = \$90.00

DC Hayes Smart Modem = \$235.00, Micro Modem II = \$289.00, Chronograph = \$225.00

C. Itoh Prowriter Printer. Better than MX80. We use constantly with our Apple and PET. Can be used on IBM, Atari, TRS-80, etc. 120 cps, friction and tractor feeds, hi resolution dot graphics, nice looking, high quality construction. Parallel - \$499.00, with IEEE interface for commodore - \$599.00, RS232 - \$660.00



3239 Linda Dr.
Winston-Salem, N.C. 27106
(919) 924-2889 (919) 748-8446
Send for free catalog!



Number Shuffle on the Atari

by Frank Roberts

A computer version of the popular game Magic Square.

Number Shuffle
requires:

Atari 400 or 800, 8K

In the days of yore, before Rubik's Cube, there existed a two-dimensional puzzle called Magic Square. It was played by rearranging a random set of numbers within a four-by-four matrix until the numbers were in numerical ascending or descending order.

This program is a computer simulation of that puzzle, and is built around a six-by-six matrix. All positions surrounding the central matrix are set to a value of -1 and used only for comparison and validation of moves. One position of the four-by-four center matrix, set to zero, is graphically represented by a blank space. Only the numbers horizontally or vertically adjacent to the space may be moved into that vacant space.

The game begins after the numbers in the NBR array are shuffled 100 times (lines 210-250) and set into the playfield array, BRD (300-370). Once the board is displayed on the screen, the user is prompted for a choice of numbers to move into the empty space. If the number is valid, the number and the space are switched. The X and Y arrays hold the screen coordinates for each number in the central matrix. The switch is made in lines 530-560 and subroutine 20-25. Lines 600-650 check the board after every switch. If all numbers are in proper ascending order, the program terminates with a congratulations and some fanfare. It will also display the total number of moves made to solve the puzzle. To check for a solution in descending order, just change line 610 to FOR J=29 TO 8.

Note: If you wish to see display of finish without working through the whole puzzle, just type "GOTO 700."

```

1 REM *****
2 REM NUMBER SHUFFLE
3 REM
4 REM Frank Roberts
5 REM 3736 Ferndale Drive
6 REM Ft. Wayne, IN 4615
7 REM *****
8 REM
9 GOTO 30
10 BRD(P)=MOVE:POSITION X(P),Y(P):IF BRD(P)<10 THEN PRINT #6;" ";
25 PRINT #6;BRD(P):RETURN
30 DIM BRD(36),NBR(16),X(36),Y(36),R$(10)
40 X(8)=3:X(9)=6:X(10)=9:X(11)=12
41 X(14)=X(8):X(15)=X(9):X(16)=X(10):X(17)=X(11)
42 X(20)=X(8):X(21)=X(9):X(22)=X(10):X(23)=X(11)
43 X(26)=X(8):X(27)=X(9):X(28)=X(10):X(29)=X(11)
44 REM
45 Y(8)=5:Y(14)=8:Y(20)=11:Y(26)=14
46 Y(9)=Y(8):Y(15)=Y(14):Y(21)=Y(20):Y(27)=Y(26)
47 Y(10)=Y(8):Y(16)=Y(14):Y(22)=Y(20):Y(28)=Y(26)
48 Y(11)=Y(8):Y(17)=Y(14):Y(23)=Y(20):Y(29)=Y(26)
49 REM
50 GRAPHICS 2:POSITION 2,4:PRINT #6;"NUMBER SHUFFLE"
60 FOR MUSIC=500 TO 0 STEP -1.5: SOUND 0,0,8,MUSIC:POKE 708,INT(RND(0)*222)
: NEXT MUSIC: SOUND 0,0,0,0
70 PRINT "DO YOU WANT INSTRUCTIONS ";: INPUT R$: IF R$(1,1)(">Y") THEN 100
80 GRAPHICS 0: POSITION 2,7
81 PRINT "NUMBER SHUFFLE IS A SOLITAIRE GAME IN WHICH 15 NUMBERS ARE
SCRAMBLED WITHIN"
82 PRINT "A 4 X 4 SQUARE. THE NUMBERS ARE THEN MOVED ONE AT A TIME INTO
AN EMPTY"
83 PRINT "SQUARE IN AN ATTEMPT TO ARRANGE THE NUMBERS IN NUMERICAL ORDER.
THE ONLY"
84 PRINT "VALID MOVE IS ONE OF THE FOUR NUMBERS"
85 PRINT "ADJACENT TO THE EMPTY SPACE IN THE SQUARE."
86 PRINT ":PRINT "WHEN YOU ARE READY, PRESS RETURN";: INPUT R$
99 REM ***** SET UP BOARD *****
100 GRAPHICS 1: POSITION 4,5: PRINT #6;"STANDBY...."
110 POSITION 3,7: PRINT #6;"I'M MIXING UP"
120 POSITION 5,9: PRINT #6;"THE BOARD"
199 REM ***** CHOOSE SET OF RANDOM NUMBERS *****
200 FOR J=0 TO 15:NBR(J+1)=J:NEXT J
209 REM ***** NOW SHUFFLE NUMBERS *****
210 FOR J=1 TO 100
220 A=INT(RND(0)*15)+1
230 B=INT(RND(0)*4)
231 IF B=0 THEN B=A-1: IF B<1 THEN B=A+1
232 IF B=1 THEN B=A-4: IF B<1 THEN B=A+4
233 IF B=2 THEN B=A+1: IF B>16 THEN B=A-1
234 IF B=3 THEN B=A+4: IF B>16 THEN B=A-4
240 TEMP=NBR(A):NBR(A)=NBR(B):NBR(B)=TEMP
250 NEXT J
299 REM ***** NOW SET UP BOARD *****
300 FOR J=1 TO 36:BRD(J)=-1:NEXT J
310 C=0
320 FOR J=8 TO 29
330 IF J=12 OR J=13 OR J=18 OR J=19 OR J=24 OR J=25 THEN 370
340 C=C+1
350 BRD(J)=NBR(C)
360 IF BRD(J)=0 THEN P=J
370 NEXT J
399 REM ***** DISPLAY BOARD *****
400 GRAPHICS 1:POKE 752,1:C=8:POSITION 6,4
410 FOR ROW=1 TO 4
420 PRINT #6:PRINT #6;" ";
430 FOR J=C TO C+3
435 IF BRD(J)=0 THEN PRINT #6;" ";:GOTO 460
440 IF BRD(J)<10 THEN PRINT #6;" ";
450 PRINT #6;BRD(J);" ";
460 NEXT J
470 C=C+6
475 PRINT #6:PRINT #6
490 NEXT ROW

```

(continued)

Number Shuffle (continued)

```

499 REM ***** GET MOVE NUMBER AND PROCESS *****
500 POP :TRY=TRY+1
505 PRINT ' ' :POKE 656,PEEK(656)-1
510 PRINT "ENTER NUMBER TO MOVE: ";
520 INPUT MOVE
530 IF BRD(P-1)=MOVE THEN BRD(P-1)=0:GOSUB 20:P=P-1:POSITION X(P),Y(P)
   :PRINT #6; ' ' :GOTO 600
540 IF BRD(P-6)=MOVE THEN BRD(P-6)=0:GOSUB 20:P=P-6:POSITION X(P),Y(P)
   :PRINT #6; ' ' :GOTO 600
550 IF BRD(P+1)=MOVE THEN BRD(P+1)=0:GOSUB 20:P=P+1:POSITION X(P),Y(P)
   :PRINT #6; ' ' :GOTO 600
560 IF BRD(P+6)=MOVE THEN BRD(P+6)=0:GOSUB 20:P=P+6:POSITION X(P),Y(P)
   :PRINT #6; ' ' :GOTO 600
570 PRINT "ILLEGAL MOVE":GOTO 510
599 REM ***** CHECK BOARD FOR WIN *****
600 C=0:IF BRD(29)() THEN POKE 656,PEEK(656)-1:GOTO 500
610 FOR J=9 TO 28
620 IF J=12 OR J=13 OR J=18 OR J=19 OR J=24 OR J=25 THEN 650
630 C=C+1
631 PRINT C,BRD(J)
640 IF BRD(J)=C THEN 650
642 POKE 656,PEEK(656)-1
644 GOTO 500
650 NEXT J
699 REM ***** CONGRATULATE WITH FANFARE *****
700 GRAPHICS 1:POSITION 2,6:PRINT #6;"CONGRATULATIONS"
710 POSITION 3,8:PRINT #6;"YOU DID IT IN"
720 POSITION 5,10:PRINT #6;TRY;" MOVES"
729 REM ***** PLAY SONG *****
800 FOR J=1 TO 6
810 READ S,S2,I
820 SOUND 0,S,10,8:SOUND 1,S-1,10,4:SOUND 2,S2,10,4:SOUND 3,S2-1,10,2
830 FOR K=1 TO I:NEXT K
840 NEXT J
850 SOUND 0,0,0,0:SOUND 1,0,0,0:SOUND 2,0,0,0:SOUND 3,0,0,0
900 DATA 162,81,15,121,60,20,96,47,25,81,40,70,96,47,20,81,40,100

```

MICRO™

TM

Letterbox

Two Many Lines

Kerry Lourash, author of "Surchange for OSI" in the August issue, noticed an error in his listing. On page 77, there are two line numbers for 1100. Type in only one.

Move the Decimal

An error in the September Software Catalog last month could have bankrupted MicroSoftware International, Inc. *Computer Business Software* was wrongly listed as \$64.70. It should have been \$6470.00. Pardon our slip.

OSI Delete Modifications

Claude Barron of Quebec, Canada, sent in this update.

In the August issue of MICRO, Morris and Morishita wrote a program for "Delete on the OSI." Here is a modification that will save you seven bytes in your program.

In their program to get the code for the "OK", you go through the output to CRT routine, and then get back to BASIC in address \$A319. Another way would simply get you back in BASIC through the warm start located at \$A274. This routine will print the "OK". Here are the necessary changes in your BASIC program:

```

18 N = 57: FOR X = M TO M + N - 1:
   READ J: POKE X, J: NEXT
22 A = INT (M/256): B = M - 256 * A:
   POKE M - 6, A: POKE M - 7, B
42 DATA 144, 5, 32, 110, 2, 240, 219,
   76, 116, 162

```

There is no need for a line 44.

I would also like to point out a little mistake in the text. When you write that the code is relocatable with the exception of the JSR at \$026E, it should be \$0266.

MICRO™

VOICE I/O THAT WORKS!

for the APPLE II and Commodore computers

Voice I/O has come a long way from the barely intelligible computer speech of only a few years ago. It is now possible to enter data or commands to your computer just by talking to it and the computer can talk back with clear, pleasant, human sounding voice.

The COGNIVOX models VIO-1002 (for Commodore) and VIO-1003 (for the Apple II+) are at the forefront of a new generation of Voice I/O peripherals that are easy to use, offer excellent performance and are affordably priced.

SOME SPECIFICATIONS

COGNIVOX can be trained to recognize up to 32 words or phrases chosen by the user. To train COGNIVOX to recognize a new word, you simply repeat the word three times under the prompting of the system.

COGNIVOX will also speak with a vocabulary of 32 words or phrases chosen by the user. This vocabulary is independent of the recognition vocabulary, so a dialog with the computer is possible. Memory requirements for voice response are approximately 700 bytes per word.

For applications requiring more than 32 words, you can have two or more vocabularies and switch back and forth between them. Vocabularies can also be stored on disk.

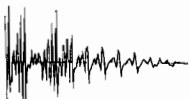

HOW IT WORKS

COGNIVOX uses a unique single-chip signal processor and an exclusive non-linear pattern matching algorithm to do speech recognition. This gives reliable operation at low cost. In fact, the performance of COGNIVOX in speech recognition is equal or better to units costing many times as much.

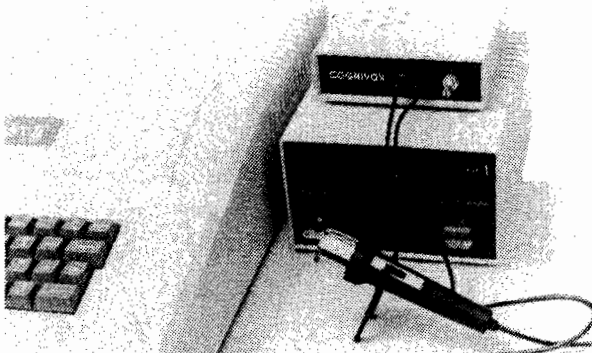

For voice output, COGNIVOX digitizes and stores the voice of the user, using a data compression algorithm. This method offers four major advantages: First there are no restrictions to the words COGNIVOX can say. If a human can say it, COGNIVOX will say it too. Second, it is very easy to program your favorite words. Just say them in the microphone. Third, you have a choice of voices: male, female, child, foreign. Fourth and foremost, COGNIVOX sounds very, very good. Nothing in the market today can even come close to the quality of COGNIVOX speech output. You can verify this yourself by calling us and asking to hear a COGNIVOX demo over the phone. Hearing is believing.

A COMPLETE SYSTEM

COGNIVOX comes assembled and tested and it includes microphone, software, power supply, built in speaker/amplifier and extensive user manual. All you need to get COGNIVOX up and running is to plug it in and load one of the programs supplied.

It is easy to write your own talking and listening programs too. A single statement in BASIC is all that you need to say or recognize a word. Full instructions on how to do it are given in the manual.

COGNIVOX model VIO-1002 will work with all Commodore computers with at least 16k of RAM. Model VIO-1003 requires a 48k APPLE II+ with 1 disk drive and DOS 3.3.

ORDER YOUR COGNIVOX NOW

Call us at (805) 685-1854 between 9am and 4pm PST and charge your COGNIVOX to your credit card or order COD. Or send us a check in the mail, specifying your computer. Price for either model of COGNIVOX is \$295 plus \$4 shipping in the U.S. (foreign add 10% we ship AIR MAIL).

VOICETEK

Dept 8, P.O. Box 388 Goleta, CA 93116

Also available for the AIM-65.
Call or write for details.

computer mail order west

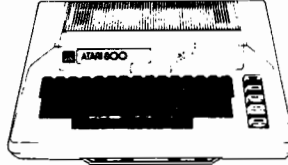

400
16K..... \$269
32K..... \$349
48K..... \$429

800 — 48K
\$669

410 Recorder.....	\$ 76.00
810 Disc Drive.....	\$449.00
822 Printer.....	\$269.00
825 Printer.....	\$589.00
830 Modem.....	\$150.00
820 Printer.....	\$259.00
850 Interface.....	\$169.00
CX40 Joystick.....	\$ 18.00
CX853 16K RAM.....	\$ 77.95

Microtek 16K RAM.....	\$ 74.95
Ramdisk (128K).....	\$429.95
Itec 48K Board.....	\$159.00
Itec 32K.....	\$ 74.00
One Year extended warranty.....	\$ 70.00
481 Entertainer.....	\$ 69.00
482 Educator.....	\$130.00
483 Programmer.....	\$ 49.00
484 Communicator.....	\$344.00

PERCOM

Disk Drives for Atari Computers

Single Drive S1..... \$649.00
 Add-on Drive A1..... \$349.00
 Dual Drive S2..... \$899.00

μ-SCI

MICRO-SCI Disk Drives for Franklin & Apple II



All.....	\$:
A40.....	\$:
A70.....	\$:
C2.....	\$:
C47.....	\$:

HOT ATARI GAMES

PAC-MAN.....	\$35.00
Centipede.....	\$35.00
Caverns of Mars.....	\$32.00
Asteroids.....	\$29.00
Missile Command.....	\$29.00
Star Raiders.....	\$39.00
Ghost Hunter.....	\$24.00

NEW RASTER BLASTER \$24

CBS ROM CARTRIDGE GAMES FOR YOUR ATARI

Krazy Shoot Out.....	\$32.00
K-razy Kritters.....	\$32.00
K-razy Antics.....	\$32.00
K-star patrol.....	\$32.00

STICK STAND \$6⁹⁹



ARCADE ACTION FROM YOUR ATARI JOYSTICK

MODEMS

Hayes	
Smart.....	\$:
Chronograph.....	\$:
Microdem II.....	\$:
Microdem 100.....	\$:
Novation Auto	
D Cat.....	\$:
Cat.....	\$:
Anchor	
Mark I (RS-232).....	\$
Mark II (Atari).....	\$
Mark III (TI-99).....	\$
Mark IV (CBM/PET).....	\$
Mark V (OSBORNE).....	\$
Mark VI (IBM-PC).....	\$
Mark VII (Auto Answer/Dial).....	\$
9 Volt Power Supply.....	\$

DATASOFT Games for the Atari

Pacific Coast Highway.....	\$25.00
Canyon Climber.....	\$25.00
Tumble Bugs.....	\$25.00
Shooting Arcade.....	\$25.00
Clowns and Balloons.....	\$25.00
Graphic Master.....	\$30.00
Graphic Generator.....	\$13.00
Micro Painter.....	\$25.00
Text Wizard.....	\$89.00
Spell Wizard.....	\$64.00
Bishops Square.....	\$25.00

ON-LINE

Jawbreaker.....	\$27.00
Softporn.....	\$27.00
Wizard and Princess.....	\$29.00
The Next Step.....	\$34.00
Mission Asteroid.....	\$22.00
Mouskattack.....	\$31.00

SYNAPSE

File Manager 800.....	\$79.00
Chicken.....	\$28.00
Dodge Racer.....	\$26.00
Synassembler.....	\$30.00
Page 6.....	\$19.00
Shamus.....	\$26.00
Protector.....	\$26.00
Nautilus.....	\$26.00
Sime.....	\$26.00
Disk Manager.....	\$24.00

MONITORS

AMDEK

300G.....	\$:
Color I.....	\$:
Color II.....	\$:
Color III.....	\$:

BMC

12" Green.....	\$
13" Color 1400.....	\$:
13" Color 1401 (Midres).....	\$:

ZENITH

ZVM121.....	!
-------------	---

SHARP

Sharp 13" Color TV.....	!
-------------------------	---

VISICORP

VISICALC

Apple II +.....	\$189.00
Atari.....	\$189.00
Commodore.....	\$189.00
IBM.....	\$189.00

For APPLE, IBM, FRANKLIN

Visidex.....	\$189.00
Visifile.....	\$189.00
Visiplot.....	\$159.00
Visiterm.....	\$189.00
Visitrend/Plot.....	\$229.00
Visi Schedule.....	\$229.00
Desktop Plan.....	\$189.00

TIMEX

TIMEX SINCLAIR 1000

LOWEST PRICE EVER \$89⁹⁹

Maxell Disks

MD I (Box of 10).....	\$
MD II (Box of 10).....	\$
MFD I (8").....	\$
MFD II (8" Double Density).....	\$
Syncom (Box of 10).....	\$

Computer Cover

Atari 400.....	\$6.99	Commodore VIC-20.....	\$
Atari 800.....	\$6.99	Commodore 8032.....	\$
Atari 810.....	\$6.99	Commodore 8050/4040.....	\$

COVERS CONTAIN ADVERTISING

west **800-648-3311**

In Nevada
 CALL
 (702)588-5654

P.O. Bo
 Sta
 NV.

FRANKLIN ACE1000

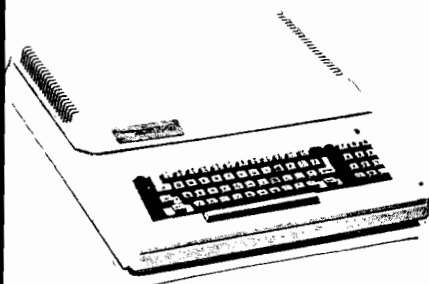

64K Personal Computer
Hardware, software and peripheral compatible with the Apple II and even has some features not found on the Apple.



CBM 8032
\$999



Commodore Business Machines

CBM 64.....	CALL
4032.....	\$ 749.00
8096 Upgrade Kit.....	\$ 369.00
Super Pet.....	\$1599.00
2031.....	\$ 369.00
8250 Double Sided Disk Drive.....	\$1699.00
D9060 5 Megabyte Hard disk.....	\$2399.00
D9090 7.5 Megabyte Hard disk.....	\$2699.00
8050.....	\$1299.00
4040.....	\$ 969.00
8300 (Letter Quality).....	\$1549.00
8023.....	\$ 599.00
4022.....	\$ 399.00
Pet to IEEE Cable.....	\$ 37.00
IEEE to IEEE Cable.....	\$ 46.00
Tractor Feed for 8300.....	\$ 240.00
New Z-Ram, Adds CP/M and 64K Ram.....	\$ 549.00

The Manager.....	\$209.00
Magis.....	Call

PROFESSIONAL SOFTWARE

Word Pro 5 +.....	\$319.00
Word Pro 4 +.....	\$299.00
Word Pro 3 +.....	\$199.00
The Administrator.....	\$379.00
InfoPro Plus.....	\$219.00
Power.....	\$ 79.00



HEWLETT PACKARD

HP-85
\$1969



HP-125.....	\$1969.00
BP-85 16K Memory Module.....	\$ 169.00
5 1/4" Dual Master Disc Drive.....	\$1799.00
Hard Disk w/ Floppy.....	\$4349.00
Hard Disk.....	\$3549.00
"Sweet Lips" Plotter.....	\$1199.00
80 Column Printer.....	\$ 649.00

HEWLETT PACKARD HP 41CV CALCULATOR

\$209



HP 41C.....	\$149.00
HP 10C.....	\$ 69.00
HP 11C.....	\$ 79.00
HP 12C.....	\$114.00
NEW 115C.....	\$119.00
NEW 16C.....	\$125.00

HPIL PERIPHERALS IN STOCK!

VIC 20
\$179

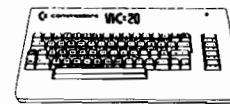

VIC 1530 Commodore Datasette.....	\$ 69.00
VIC 1540 Disk Drive.....	\$ 339.00
VIC 1541 (64 Disk Drive).....	CALL
VIC 1515 VIC Graphic Printer.....	\$339.00
VIC 1210 3K Memory Expander.....	\$ 32.00
VIC 1110 8K Memory Expander.....	\$ 53.00
16K VIC Expansion.....	\$ 94.00
VIC 1011 RS232C Terminal Interface.....	\$ 43.00
VIC 1112VIC IEEE-488 Interface.....	\$ 86.00
VIC 1211 VIC 20 Super Expander.....	\$ 53.00
VIC Mother Board.....	\$ 99.00

NEC COMPUTERS

8001-A.....	\$749.00
8031.....	\$749.00
8012.....	\$549.00

PRINTERS

8023.....	\$ 549.00
7710/7730.....	\$2399.00
3510/3530.....	\$1599.00

MONITORS

JB-1201.....	\$179.00
JC-1201.....	\$349.00
JC-1202.....	\$899.00



SHARP PC-1500 POCKET COMPUTER

ALSO AVAILABLE:
Printer w/cassette interface
cassette tape recorder
and 4K and 8K RAM EXTENSIONS

PRINTERS Smith-Corona

TP-1
\$599

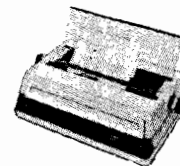

Call for price and information on the new "intelligent" letter quality printer.

C. ITOH (TEC)

Starwriter (F10-40CPS).....	\$1399.00
Printmaster (F10-55CPS).....	\$1749.00
Prowriter 80 Col (P).....	\$ 499.00
Prowriter 80 Col (S).....	\$ 629.00
Prowriter 2 (132 Col).....	\$ 799.00

OKIDATA

82A.....	\$ 469.00
83A.....	\$ 689.00
84 Parallel.....	\$1099.00
84 Serial.....	\$1249.00

— ALSO —

Talley 8024-L.....	\$1629.00
IDS Prism.....	CALL

Televideo Terminals



910.....	\$579
912C.....	\$699
920C.....	\$749
925C.....	\$749
950.....	\$950

802.....	\$ Call
802H.....	\$ Call
816.....	\$ Call
806.....	\$ Call

In-stock items shipped same day you call. No risk, no deposit on C.O.D. orders. Pre-paid orders receive free shipping within the continental United States with no waiting period for certified checks or money orders. Add 3% (minimum \$3.00) shipping and handling on all C.O.D. and Credit Card orders. NV and PA residents add sales tax. All items subject to availability and price change. **NOTE:** We stock manufacturer's and third party software for most all computers on the market! Call today for our new catalog.

ADDITIONAL MANUFACTURER'S DISCOUNTS AVAILABLE TO QUALIFIED EDUCATIONAL INSTITUTIONS

800-233-8950 east

477 E.
THIRD ST.
Williamsport
PA 17701

IN PA
CALL
(717)327-9575

computer mail order east

Sensible Use of Apple Game Paddles

by Harry L. Pruetz

Some programming suggestions to improve the validity of game-paddle inputs.

Paddle Use

requires:

Apple computer with either Integer or Applesoft BASIC and the Apple game paddles

When using Apple II game paddles, there are both hardware and software problems involved. With some knowledge of inherent limitations, the paddles can add to the enjoyment of computer games, both while designing a game and playing it.

My Apple II came with two paddles hooked up to the game I/O connector. The paddles were actually rotating potentiometers, rather than the joystick-type paddles available. Unlike two-player games, games designed for one player using both paddles for x-y control would be better played with a real joystick controlling both x and y coordinate movements.

The most obvious limitation on both game paddles is the 300-degree physical limit on control knob movement. Numerical values possible from a paddle range from 0 at the complete counter-clockwise position, up to 255 at the complete clockwise position. However, these values are available for only about a 150-degree rotation of the knob.

The values read from BASIC using the PDL function may be expressed as a function of the angle of the paddle knob as follows:

Angle	Value
0-29	—
30-65	0
66-101	0-63
102-137	64-127
138-173	128-191
174-209	192-255
210-329	255
330-359	—

The value read from a paddle may change by 1 when the knob is moved slightly

more than half of a degree! Labeling the paddles and marking the actual ranges are quite helpful for many games.

The paddle cable that plugs into the game I/O connector is a source of problems. Each time the paddles are disconnected, cable pins may get bent when reconnecting the paddles. The pins may be bent back into shape and the electrical connection will still be sound. However, a simple program to sample and display paddle values should be run occasionally to make sure the paddles are functioning correctly.

A monitor routine measures a paddle value by delaying 12 microseconds for each unit value measured after the paddle is triggered. Thus a value of 255 takes three milliseconds to measure. Times of one to three milliseconds for each PDL call are not excessive for Integer or Applesoft BASIC. There are usually many other statements executed between PDL calls. Compiled

BASIC or faster computer languages may still use the paddles for game input without noticeable effect from the slow timing speed. It is usually the machine-language implementations of sophisticated, fast-action games that avoid using paddles.

The program listed is a RAM Applesoft BASIC program to test and demonstrate some software techniques useful with game paddles.

Lines 100 through 195 merely sample paddle 0 and print a value if it is different from the previous sample. Line 110 exits the sampling loop when any key is pushed. The paddle may be set to any value greater than 0 and less than 255, and left untouched for a while. Because of the sensitivity of the pot and the monitor routine which determines the value PDL(0), the value often skips back and forth between two consecutive numbers. This causes errors in some games that are not the player's

Listing 1

```

10 REM *****
15 REM * PADDLE USE DEMOS
20 REM *
25 REM * BY HARRY L. PRUETZ
30 REM *****
35 DIM XC%(128),YC%(128)
40 DEF FN X(D) = 4 * INT (1 + INT ( PDL (0) * 68) / 255)
45 DEF FN Y(D) = 2 * INT (2 + INT ( PDL (1) * 92) / 255)
47 GOTO 95
50 REM *** PDL(0) CALC ***
55 D = ( PDL (0) - 4 * XP) / 4:XP = XP + SGN (D) * INT ( ABS (D)):X = 1
  1 + 4 * XP: RETURN
60 REM *** PDL(1) CALC ***
65 D = (255 - PDL (1) - 3 * YP) / 3:YP = YP + SGN (D) * INT ( ABS (D))
  :Y = 10 + 2 * YP: RETURN
70 REM *** FRAC PDL(0) CALC ***
75 F = 255 / 45:D = ( PDL (0) - F * XP) / F:XP = XP + SGN (D) * INT ( ABS
  (D)):X = 6 * XP: RETURN
80 REM *** FRAC PDL(1) CALC ***
85 F = 255 / 45:D = (255 - PDL (1) - F * YP) / F:YP = YP + SGN (D) * INT
  ( ABS (D)):Y = 4 * YP: RETURN
95 POKE - 16368,0: HOME
100 REM
101 REM *****
102 REM * PADDLE 0 SAMPLING
103 REM *****
104 REM
105 VP = PDL (0)
110 IF PEEK ( - 16334) > 127 THEN 195
115 VC = PDL (0)
120 IF VC < > VP THEN PRINT VC;" ";
125 VP = VC
130 GOTO 110

```

(continued)

Listing 1 (continued)

```

195 POKE - 16368,0: HOME
200 REM
201 REM *****
202 REM * PADDLE 1 AVERAGING
203 REM *****
204 REM
205 VP = PDL (1)
210 IF PEEK ( - 16384) > 127 THEN 295
215 VC = INT ( INT ( PDL (1) + VP) / 2)
220 IF VC < > VP THEN PRINT VC;" ";
225 VP = VC
230 GOTO 210
295 POKE - 16368,0: HOME
300 REM
301 REM *****
302 REM * SMOOTH FADING TRAIL
303 REM *****
304 REM
305 PC = 1:NP = 128
310 X = FN X(0)
315 Y = FN Y(1)
320 FOR I = 1 TO 128:XC%(I) = X:YC%(I) = Y: NEXT I
325 HGR2
330 IF PEEK ( - 16384) > 127 THEN 395
335 HCOLOR= 0: HPLOT X - 3,Y - 3 TO X + 3,Y + 3: HPLOT X - 3,Y + 3 TO X +
3,Y - 3
340 HPLOT XC%(PC),YC%(PC)
345 HCOLOR= 3: HPLOT X,Y
350 XC%(PC) = X:YC%(PC) = Y
355 PC = PC + 1: IF PC > NP THEN PC = 1
360 X = INT ( INT ( X + FN X(0)) / 2)
365 Y = INT ( INT ( Y + FN Y(1)) / 2)
370 HPLOT X - 3,Y - 3 TO X + 3,Y + 3: HPLOT X - 3,Y + 3 TO X + 3,Y - 3
375 GOTO 330
395 POKE - 16368,0: HOME
400 REM
401 REM *****
402 REM * DISCRETE FADING TRAIL
403 REM *****
404 REM
405 PC = 1:NP = 128:XP = 0:YP = 0
410 GOSUB 50
415 GOSUB 60
420 FOR I = 1 TO 128:XC%(I) = X:YC%(I) = Y: NEXT I
425 HGR2
430 IF PEEK ( - 16384) > 127 THEN 495
435 HCOLOR= 0: HPLOT X - 3,Y - 3 TO X + 3,Y + 3: HPLOT X - 3,Y + 3 TO X +
3,Y - 3
440 HPLOT XC%(PC),YC%(PC)
445 HCOLOR= 3: HPLOT X,Y
450 XC%(PC) = X:YC%(PC) = Y
455 PC = PC + 1: IF PC > NP THEN PC = 1
460 GOSUB 50
465 GOSUB 60
470 HPLOT X - 3,Y - 3 TO X + 3,Y + 3: HPLOT X - 3,Y + 3 TO X + 3,Y - 3
475 GOTO 430
495 POKE - 16368,0: TEXT : HOME
500 REM
501 REM *****
502 REM * FRACTIONAL PADDLE INC
503 REM *****
504 REM
505 XP = 0:YP = 0: GOSUB 70: GOSUB 80:XC = X:YC = Y
510 HGR2 : HCOLOR= 2:SW = 0
515 FOR I = 0 TO 275 STEP 2
520 HPLOT I,0 TO I,183
525 NEXT I
530 HCOLOR= 1: FOR I = X + 1 TO X + 5 STEP 2: HPLOT I,Y TO I,Y + 3: NEXT
I
535 IF PEEK ( - 16384) > 127 THEN 595
540 GOSUB 70: GOSUB 80: IF X = XC AND Y = YC THEN 535
545 HCOLOR= 0: FOR I = XC + 1 TO XC + 5 STEP 2: HPLOT I,YC TO I,YC + 3: NEXT
I
550 HCOLOR= 0: HPLOT XC + 2,YC + 1 TO X + 2,Y + 1
555 HCOLOR= 1: FOR I = X + 1 TO X + 5 STEP 2: HPLOT I,Y TO I,Y + 3: NEXT
I
560 XC = X:YC = Y: GOTO 535
595 POKE - 16368,0: TEXT : HOME
999 END

```

fault. When the paddle cable is not properly plugged into the game I/O connector, values may vary even more, sometimes changing when the other paddle is moved.

Lines 200 through 295 provide a more stable readout from paddle 1. A different paddle is used here to allow the program to be used for paddle checkout. When paddle 1 is not being moved, the averaged value VC changes only in very rare cases. A disadvantage of this averaging method is that the range is now only 0 through 254. Averaging also slows down the rapidity with which VC may change. Paddle 0 in the first case can be moved from one extreme to the other during only three or four samplings. Paddle 1 in this case takes about five more samplings for VC to catch up to the actual PDL(1) value. Line 215 could also be changed to give the previous value more weight with the penalty of slowing down the sampling even more. For example:

$$215 \text{ VC} = \text{INT}(\text{INT}(\text{PDL}(1) + 2 * \text{VP}) / 3)$$

The INT functions required in Applesoft BASIC make the above statement more inefficient than when using Integer BASIC.

Lines 300 through 395 use high-resolution graphics to demonstrate paddle sampling with averaging. XC% and YC% are arrays used as circular queues to allow display of the last 128 locations of the 'X' shape. The functions at lines 40 and 45 convert a paddle value into x and y coordinates. Again, INT functions are required in Applesoft BASIC to insure integer arithmetic. The numbers in the defined functions are fairly easy to obtain by using the "slope-intercept form" for straight lines. From Analytic Geometry:

$$f = a + mg,$$

where g is the independent variable,

m is the slope of the line,

a is the value of f at g = 0,

and f is the dependent variable.

We want the paddles to determine screen location. Only multiples of 4 are used as x-coordinate locations, so the figure 'X' may be plotted at 4, 8, ..., and 276 without x - 3 or x + 3 causing "illegal quantity" errors. Ignoring the multiplier of 4 for now, f should be 1 when PDL(0)=0, and 69 when PDL(0)=255. For $f = a + m * \text{PDL}(0)$, $a = 1$ and $m = (69 - 1) / (255 - 0)$, so that $f = 1 + [\text{PDL}(0) * 68] / 255$ and $x = 4 * f$. Thus we get line 40, where D is an unused dummy variable:

```

40 DEF FN X(D) = 4 * INT(1 + INT
(PDL(0) * 68) / 255)

```

Multiples of 2 are used as y-coordinate locations, so the figure 'X' may be plotted at 4, 6, ..., and 188

without $y-3$ or $y+3$ causing "illegal quantity" errors. Ignoring the multiplier of 2 for now, f should be 2 when $PDL(1)=0$, and 94 when $PDL(1)=255$. For $f = a+m \cdot PDL(1)$, $a=2$, $m = (94-2)/(255-0)$, and $y = 2 \cdot f$. Thus we get line 45, where D is an unused dummy variable:

```
45 DEF FN Y(D) = 2*INT(2+INT
(PDL(1)*92)/255)
```

Line 320 initializes the circular queue. The actual loop is lines 330 through 375. The loop performs the following steps:

1. Erase current 'X'.
2. Erase last point in trail.
3. Plot current point in trail.
4. Save point location in queue.
5. Adjust queue pointer.
6. Plot next 'X'.

Lines 360 and 365 average the x and y values obtained from the paddle functions. The averaging has a smoothing effect on movements of the figure 'X' as it is moved around on the high-resolution grid.

Lines 400 through 495 demonstrate a way of obtaining reliable paddle input without averaging. The routine at line 50 is essentially the same as the one at line 60. However, the $PDL(0)$ routine will be explained in detail. Let us consider the case of $PDL(0)=0$ and $XP=0$.

If $PDL(0)$ is increased to 4, then XP becomes 1. If $PDL(0)$ changes back to 3 by itself, there will be no new XP because the difference is only 1. Now, when $PDL(0)$ is increased to 7, there will still be no change in XP . If $PDL(0)$ changes to 8 by itself and then back to 7 again, the value $XP=2$ will be calculated and will remain in effect until $PDL(0)$ is changed to 4 or 12. Thus the output of this routine is stable without averaging. I have chosen to call the method differencing. Note that merely dividing $PDL(0)$ by 4 would not give stable results. The use of $SGN(D) \cdot INT(ABS(D))$ is used since $INT(-1.1)$ gives -2 instead of the -1 desired.

Note also that $255-PDL(1)$ is used in line 65 rather than just $PDL(1)$. This gives the same "intuitive" coordinate change for the y -coordinate as paddle 0 does for x -coordinate values. Thus, clockwise rotation of paddle 1 causes movement from the bottom to the top of the CRT display.

The rest of this case is essentially the same as lines 300 through 395.

Finally, we have a demonstration in lines 500 through 595 of fractional ranges of the paddles. The routines that sample the paddles are at lines 70 and 80. The fraction involved is $255/45$ or 5.66667 . This gives a high-resolution display of 46 by 46 cells six points wide and four points deep. Only 276 of 280

horizontal, and 184 of 192 vertical high-resolution points are used. The white cursor is plotted and erased using the complimentary color between the background lines. Straight black lines are drawn between each position of the cursor as it is moved using the game paddles.

Fractions much smaller than 5.66667 may be used in the difference calculations for game paddles. I have used a fraction as small as 1.275 to get 200 stable values from a game paddle. The values are not exactly "one-to-one" for a game paddle. For example, $PDL(0)=7$ may give a calculated value of 5 or 6 depending on the previous value. However, the calculated values are stable and the game player cannot see the difference.

If you have Integer or Applesoft BASIC programs that use game paddles and do not give satisfactory results, you may consider making a few simple changes similar to the given examples. Programs that use only a few keys may also be changed to use the game paddles. Above all, sit back and relax. An aching back caused by leaning over a keyboard is not really necessary.

Contact the author at 2929 Clydedale, #376, Dallas, TX 75220.

MICRO

FORTH-79

Ver. 2 For your APPLE II/II+

The complete professional software system, that meets ALL provisions of the FORTH-79 Standard (adopted Oct. 1980). Compare the many advanced features of FORTH-79 with the FORTH you are now using, or plan to buy!

FEATURES	OURS	OTHERS
79-Standard system gives source portability.	YES	_____
Professionally written tutorial & user manual	200 PG.	_____
Screen editor with user-definable controls.	YES	_____
Macro-assembler with local labels.	YES	_____
Virtual memory.	YES	_____
Both 13 & 16-sector format.	YES	_____
Multiple disk drives.	YES	_____
Double-number Standard & String extensions.	YES	_____
Upper/lower case keyboard input.	YES	_____
LO-Res graphics.	YES	_____
80 column display capability	YES	_____
Z-80 CP/M Ver. 2.x & Northstar also available	YES	_____
Affordable!	\$99.95	_____
Low cost enhancement option:		
Hi-Res turtle-graphics.	YES	_____
Floating-point mathematics.	YES	_____
Powerful package with own manual, 50 functions in all, AM9511 compatible.		
FORTH-79 V.2 (requires 48K & 1 disk drive)	\$ 99.95	
ENHANCEMENT PACKAGE FOR V.2		
Floating point & Hi-Res turtle-graphics	\$ 49.95	
COMBINATION PACKAGE	\$139.95	
(CA res. add 6% tax: COD accepted)		

MicroMotion

12077 Wilshire Blvd. #. 506
L.A., CA 90025 (213) 821-4340
Specify APPLE, CP/M or Northstar
Dealer inquiries invited.



SIG-FORTH V 1.0

The only stand-alone Forth system
for O.S.I. serial machines

Features:

- Complete Forth source code
- Advanced Screen editor w/source
- 6502 macro assembler w/source
- Double number and CASE extensions
- Vectored boot capability
- Several Utility Screens
- Complete glossary

Dos Includes:

- Bi-Directional NEC driver
 - 65U read capability
 - NMhz Capability
- \$100.00**
POSTAGE PAID

DIGI COM ENGINEERING, INC.

P.O. Box 1656
Kodiak, Alaska 99615

ORDERING INFORMATION: Check, money order or C.O.D.'s accepted. Shipment VIA first class mail. Allow approximately one week for delivery.

NEW FROM D & N MICRO PRODUCTS, INC.

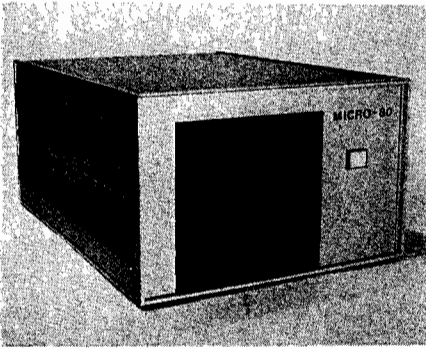

MICRO-80 COMPUTER

Z80A CPU with 4MHz clock and CP/M 2.2 operating system. 64K of low power static RAM. Calendar real time clock. Centronics type parallel printer interface. Serial interface for terminal communications, dip switch baud rates of 150 to 9600. 4" cooling fan with air intake on back of computer and discharge through ventilation in the bottom. No holes on computer top or side for entry of foreign object. Two 8" single or double sided floppy disk drives. IBM single density 3740 format for 243K of storage on each drive. Using double density with 1K sectors 608K of storage is available on a single sided drive or 1.2 meg on a double sided drive. Satin finish extruded

aluminum with vinyl woodgrain decorative finish. 8 slot backplane for expansion. 48 pin buss is compatible with most OSI boards. Uses all standard IBM format CP/M software.

Model 80-1200	\$2995
2 8" single sided drives, 1.2 meg of storage	
Model 80-2400	\$3495
2 8" double sided drives, 2.4 meg of storage	
Option 001	\$ 95
Serial printer port, dip switch baud rate settings	

Software available in IBM single density 8" format.

Microsoft

Basic-80	\$289
Basic Compiler	\$329
Fortran-80	\$410
Cobol-80	\$574
Macro-80	\$175
Edit-80	\$105
Mu Simp/Mu Math	\$224
Mu Lisp-80	\$174

Digital Research

PL/1-80	\$459
Mac	\$ 85
Sid	\$ 78
Z-Sid	\$ 95
C Basic-2	\$110
Tex	\$ 90
DeSpool	\$ 50
Ashton-Tate	
dBase II	\$595

Micropro

Wordstar	\$299
Mail-Merge	\$109
Spellstar	\$175
SuperSort I	\$195
Pascal	
Pascal/MT +	\$429
Pascal Z	\$349
Pascal M	\$355

Convert almost any static memory OSI machine to CP/M® with the D & N-80 CPU Board.

Z80A CPU with 4MHz clock. 2716 EPROM with monitor and bootstrap loader. RS-232 serial interface for terminal communications or use as a serial printer interface in a VIDEO system. Disk controller is an Intel 8272 chip to provide single or double density disk format. 243K single density or 608K double density of disk storage on a single sided 8" drive. A double sided drive provides 1.2 meg of storage. DMA used with disk controller to unload CPU during block transfers from the disk drives. Optional Centronics type parallel printer port com-

plete with 10 ft. cable. Optional Real Time Calendar Clock may be set or read using 'CALL' function in high level languages. Power requirements are only 5 volts at 1.4 amps. Available with WORDSTAR for serial terminal systems.

INCLUDES CPM 2.2

D & N-80 serial	\$695
D & N-80 serial w/Wordstar	\$870
D & N-80 video	\$695
Option 001	\$ 80

parallel printer and real time calendar clock

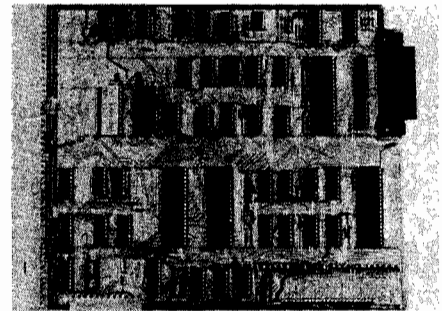

D & N-80 CPU BOARD

OTHER OSI COMPATIBLE HARDWARE

IO-CA10X Serial Printer Port \$125
Compatible with OS-65U and OS-65D software

IO-CA9 Parallel Printer Port \$175
Centronics standard parallel printer interface with 10 ft. flat cable

BP-580 8 Slot Backplane \$ 47
Assembled 8 slot backplane for OSI 48 pin buss

24MEM-CM9 \$380 **24MEM-CM9F** \$530
16MEM-CM9 \$300 **16MEM-CM9F** \$450
8MEM-CM9 \$210 **8MEM-CM9F** \$360
BMEM-CM9F \$ 50 **FL470** \$180

24K memory/floppy controller card supports up to 24K of 2114 memory chips and an OSI type floppy disk controller. Available fully assembled and tested with 8, 16, or 24K of memory, with floppy controller (F). Controller supports 2 drives. Needs separated clock and data inputs. Available Bare (BMEM-CM9F) or controller only (FL-470). Ideal way to upgrade cassette based system

C1P-EXP Expansion Interface \$ 65
Expansion for C1P 600 or 610 board to the OSI 48 pin buss. Requires one slot in backplane. Use with BP-580 backplane

BIO-1600 Bare IO card \$ 50
Supports 8K of memory, 2 16 bit parallel ports may be used as printer interfaces. 5 RS-232 serial ports, with manual and Molex connectors

DSK-SW Disk Switch \$ 29
Extends life of drive and media. Shuts off minifloppy spindle motor when system is not accessing the drive. Complete KIT and manual

Disk Drives and Cables

8" Shugart SA801 single sided	\$395
8" Shugart SA851 double sided	\$585
FLC-66ft. cable from D & N or OSI controller to 8" disk drive	\$ 69
5 1/4" MPI B51 with cable, power supply and cabinet	\$450
FLC-5 1/4 ft. cable for connection to 5 1/4 drive and D & N or OSI controller, with data separator and disk switch	\$ 75

Okidata Microline Printers

ML 82A Dot Matrix Printer	\$534
120 CPS, 80/120 columns, 9.5" paper width, friction or pin feed	
ML 83A Same as 82A except	\$895
16" paper width, 132/232 columns with tractor feed	
ML 84 Same as 82A except 200 CPS,	\$1152
16" paper width, 132/232 columns, 2K buffer, dot addressable graphics, with tractor feed	

D & N Micro Products, Inc.

3684 N. Wells St.
Fort Wayne, Ind. 46808
(219) 485-6414



TERMS \$2.50 shipping, Foreign orders add 15%.
Indiana residents add 4% sales tax.

Space Invasion for OSI C1P/Superboard

by John S. Seybold

Space Invasion

requires:

OSI C1P or Superboard

In this real-time arcade game you must fight waves of incoming aliens. Each time you clear the screen of aliens it refills with more aliens, faster and closer than the last bunch. The more times you clear the screen, the more points each alien is worth.

The aliens are moved by the user routine; their addresses are updated in line 2510. Z tells the routine which way to move the aliens. To adjust the pace of the game, you may adjust line 2082 or line 2520. If you remove all of the REM statements, the program should run in 4K of memory.

Mr. Seybold is employed by General Dynamics in Pomona, CA. He has owned an OSI Superboard for a year and a half. Address correspondence to 3210 Quartz Lane, #A-10, Fullerton, CA 92631.

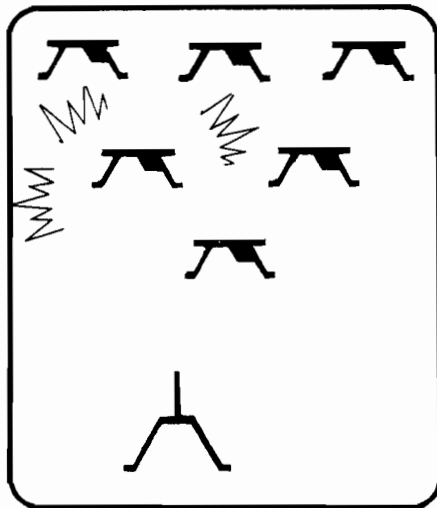

Space Invasion

```

2 DIMA(49):W=53366:WW=W-17:AZ=750:X=54214:Y=54235
5 REM-ADJUST LINES 2520 AND 2062 FOR SPEED,ADD SOUND TO 650,7900
10 GOSUB200:POKE11,34:POKE12,2:SC=0
20 HS#="HIGH SCORE":PRINT"      SPACE INVASION"
40 PRINT"      -----":GOSUB200:V=32:KB=57008:M=251
50 PRINT"C > RIGHT":PRINT"X > LEFT":PRINT"M > FIRE":PRINT
80 PRINT:INPUT"DIFFICULTY LEVEL (1-5)":D:IF(D<1)OR(D>5)THEN80
100 PRINT"HIT 'M' TO START":POKE530,1:POKEKB,M
110 IFPEEK(KB)=MTHEN910
120 GOTO110
200 FORK=1TO12:PRINT:NEXT:RETURN
400 REM-TURRET FIRE ROUTINE*****
410 TM=P-V:IFPEEK(TM)<>AATHENPOKETM,39:RETURN
420 POKETM,V:RM=RM-1:TM=0:SC=SC+10:RETURN
600 REM-TURRET FIRE UPDATE ROUTINE***
610 J=PEEK(TM):IFJ=AATHENTM=0:RETURN
620 POKETM,V:TM=TM-V:IFTM<(KB)THENTM=0:RETURN
625 IFTM=AATHENTM=0:RETURN
630 J=PEEK(TM):IFJ=VTHENPOKETM,39:RETURN
640 POKETM,V:TM=0:IFJ<>AATHENRETURN
650 RM=RM-1:SC=SC+10:SC#=STR$(SC):FORK=1TOLEN(SC#)
660 POKEW+K,ASC(MID$(SC#,K,1)):NEXTK:IFSC<HSTHENRETURN
670 HS=SC:REM-HIGH SCORE PRINT ROUTINE*****
680 FORK=1TOLEN(HS#+STR$(HS))
690 POKEW+K,ASC(MID$(HS#+STR$(HS),K,1)):NEXTK:RETURN
700 REM-ALIEN FIRE UPDATE ROUTINE****
710 POKEAF,V:AF=AF+V:J=PEEK(AF):IF(J=AA)OR(AF>P)THENAF=0:RETURN
720 IFJ=CVTHENPOKEAF,V:AF=0:RETURN
730 POKEAF,39:RETURN
900 REM-SET UP SCREEN*****
910 FORK=1TO25:PRINT:NEXT:POKE54149,V:Z=54087:CV=161
920 FORK=1TO4:POKEZ,CV:POKEZ+1,CV:POKEZ+V,CV
930 POKEZ+33,CV:POKEZ-V,CV:POKEZ-31,CV:Z=Z+5:NEXTK:P=54224:BB=49
1000 B=1:AF=0:TM=0:RM=BB:C=10:Z=1:AA=231:TURRET=236
1010 CL=7:FORK=1TOCL:READA(K):A(K)=A(K)+V*0:POKEA(K),AA
1020 FORI=KTOBBSTEPCL:IFI=KTHENNEXTI
1030 A(I)=A(I-CL)+2*V:POKEA(I),AA:NEXTI:NEXTK:POKEP,TU:GOSUB690
1040 FORI=546TO623:READJ:POKEI,J:NEXTI
2000 REM-MOVE ALIENS? PROGRAM LOOP*****
2010 C=C-1:IFPEEK(A(B))=VTHENB=B+1
2020 IFPEEK(A(BB))=VTHENBB=BB-1
2062 IFC=>0THENFORK=1TO(60-5*D):NEXTK:GOTO4020
2083 IFRTHEN2500
2085 IFZ<0THEN2100
2090 FORK=XTOR(B)STEP-V:IFPEEK(K)=AATHENZ=V-Z:R=1:GOTO4020
2095 NEXTK:GOTO2500
2100 FORK=XTOR(B)STEP-V:IFPEEK(K)=AATHENZ=V-Z:R=1:GOTO4020
2110 NEXTK
2500 IFZ>0THENPOKEAZ,Z:GOTO2510
2505 POKEAZ,256+Z
2510 X=USR(X):FORK=BT0(BB:A(K))=A(K)+Z:NEXTK:IFA(BB)=>XTHEN7900

```

Space Invasion (continued)

```

2520 R=0:C=.5+(RM/3):IFABS(Z)>1THENZ=Z-V
4000 REM-CHECK FOR TURRET FIRE*****
4020 J=PEEK(KB):IF((JORM)=M)ANDTM=0THENGOSUB410
4490 REM-CHECK FOR TURRET MOVEMENT**
4500 IF(JOR191)>>191THEN4600
4520 IFP<>YTHEN:POKEP,V:P=P+1:POKEP,TU:GOTO5000
4600 IF(JOR127)>>127THEN5000
4610 IFP<>XTHEN:POKEP,V:P=P-1:POKEP,TU
4990 REM-ALIEN FIRE*****
5000 IFAF<>0THENGOSUB710:GOTO5100
5010 AL=BB-INT(5*RND(3)):IFAL<BTHENAL=BB
5040 IFPEEK(A(AL))=AATHENAF=A(AL)+V:POKEAF,39
5100 IFAF=PTHEN7900
5200 IFTMTHENGOSUB610:IFRM<=0THEN9000
5210 GOTO2010
7890 REM-TURRET DESTROYED*****
7900 FORI=1TO200:POKEP,2:POKEP,3
7920 POKEP,232:POKEP,233:POKEP,32:NEXT:GOSUB200
7950 PRINT"THE ALIENS HAVE":PRINT"PRINT"OVERCOME YOUR DEFENSES"
7960 PRINT"PRINT"AND LANDED!!":GOSUB200
7965 PRINT"YOUR SCORE WAS":SC:PRINT
7980 FORK=1TO8:POKEW+K,V:NEXTK:FORI=1TO3000:NEXTI
8000 FORK=XTOY:POKEK,V:NEXT:POKE530,0
8020 GOSUB200:PRINT"SPACE INVADERS":GOSUB200
8025 INPUT"PLAY AGAIN":K$:IFLEFT$(K$,1)="Y"THENRESTORE:GOTO10
8030 FORK=WTOY:POKEK,V:NEXTK:END
8990 REM-NEXT SCREEN*****
9000 RESTORE:IFD<7THEND=D+1
9010 FORK=XTOY:POKEK,V:NEXT:IFTM<>0THENPOKETM,V
9045 IFAF<>0THENPOKEAF,V
9050 POKEP,V:GOTO910
10000 DATA 53354,53356,53358,53360,53362,53364,53366
10010 DATA 216,169,211,133,217,169,0,133,216,160,255,177,216,201,231
10020 DATA 208,3,32,66,2,136,208,244,198,217,169,207,197,217,208,234
10030 DATA 96,169,32,145,216,152,72,174,238,2,48,27,24,109,238,2,168
10040 DATA 176,0,169,231,145,216,104,168,136,96,230,217,169,231,145
10050 DATA 216,198,217,104,168,136,96,24,109,238,2,169,24,144,228
    
```

MICRO

Don't Forget!

Visit

MICRO

at the

Northeast
Computer Show

Nov. 11-14, 1982

Hynes Auditorium
Boston, Massachusetts

Booth #406

We look forward to meeting you!



VANTEC 80

The COMPLETE 80 COLUMN VIDEO Board with HIGH RESOLUTION GRAPHICS CAPABILITY for your APPLE.

At last... a complete video board for your Apple II or Apple II+ microcomputer. No longer are "Soft Switches, Lower case Eproms" and low quality graphics necessary. By mixing the 80 column video directly onto the normal video output, either high resolution graphics, low resolution graphics or 40 column text may be combined with the 80 column display.

Save \$90 on Introductory Special... (List \$389)... **\$299***

RC Electronics Inc.

7265 Tuolumne Drive, Goleta, CA 93117
(805) 968-6614



Dealer Inquiries Invited

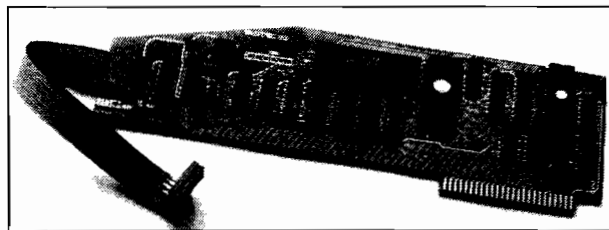

- The VANTEC 80 is the only board that can overlay an 80 character display on the normal Apple video.
- Software switching between 80 & 40 character displays.
- Mix High Res or Lo Res graphics with the 80 character text display.
- Upper and lower case characters with shift mod provided.
- Flashing or inverted block video cursor.
- Apple-soft, Apple Pascal and Z80 Softcard® compatible.

*Special Introductory Pricing available for systems purchased before Nov. 30, 1982. Credit card orders add 3%. California orders add 6% sales tax.

Apple Shutdown

by Eric Grammer

A type and RUN low-resolution graphics game.

Shoot Down
requires:

Apple II with Applesoft and
game paddles

Here is a simple game with a short machine-language sound program. The object of the game is to shoot at all the columns with dots in them. The dots will fire back at you. To move your ship, use paddle (0). To fire, press the button.

The machine-language section should be BSAVED with A\$300, L\$30. The lo-res graphics listing is straightforward and is fairly self-explanatory. Good shooting!

Assembler Listing Laser Fire

```

1 ;*****
2 ;*
3 ;*   LASER FIRE
4 ;*
5 ;*   ERIC GRAMMER
6 ;*
7 ;*****
8   ORG $300
9 ;*****
10 REPEAT EPZ $06
11 USRRPT EPZ $07
12 YLOOP EQU $330
13 XLOOP EQU $331
14 SPKR EQU $C030
15 ;*****
16 START:
17   LDA #$00
18   STA REPEAT
19 LOOP  LDA REPEAT
20   CMP USRRPT
21   BEQ END
22   INC REPEAT
23   JSR FIRE
24   JMP LOOP
25 END   RTS
26 FIRE  LDX #$00
27 YCLEAR LDY #$00
28   LDA SPKR
29   DELAY INY
30   TYA
31   STX YLOOP
32   CMP YLOOP
33   BMI DELAY
34   INX
35   STX XLOOP
36   LDA $FF
37   CMP XLOOP
38   BNE YCLEAR
39   RTS
40   END
0300 A9 00
0302 85 06
0304 A5 06
0306 C5 07
0308 F0 08
030A E6 06
030C 20 13 03
030F 4C 04 03
0312 60
0313 A2 00
0315 A0 00
0317 AD 30 C0
031A C8
031B 98
031C 8E 30 03
031F CD 30 03
0322 30 F6
0324 E8
0325 8E 31 03
0328 A9 FF
032A CD 31 03
032D D0 E6
032F 60
0330

```

The author may be contacted at 95 Old Street Road, Peterborough, NH 03458.

Listing 1: Shoot Down Applesoft Listing

```

10 PRINT : PRINT CHR$ (4)"BLOAD LASER FIRE.OBJ"
20 TEXT : HOME : PRINT "SHOOT DOWN"
25 DIM V(40)
30 PRINT : PRINT "WHAT'S YOUR SKILL LEVEL?"
40 PRINT : PRINT "1. SIMPLETON"
50 PRINT "2. FAIR"
60 PRINT "3. GOOD"
70 PRINT "4. EXCELLANT"
80 PRINT "5. MR. PERFECT"
90 PRINT : PRINT "PLEASE PRESS THE NUMBER OF YOUR CHOICE.:"
100 GET SK$: IF VAL (SK$) < 1 OR VAL (SK$) > 5 THEN 100
110 SKILL = VAL (SK$)
120 VTAB SKILL + 4: FLASH : VTAB 1: PRINT SKILL:; NORMAL
130 VTAB 20: PRINT "PRESS ANY KEY TO BEGIN... ";: GET AS
140 POKE 7,1
160 TEXT : HOME
170 GR : COLOR= 1
180 X = INT ( PDL (0) / 7.3): GOSUB 380
190 FOR X = 1 TO 21 STEP 4: FOR Y = 3 TO 35 STEP 4: PLOT Y,X: NEXT Y,X
200 COLOR= 5
210 FOR X = 3 TO 19 STEP 4: FOR Y = 5 TO 33 STEP 4: PLOT Y,X: NEXT Y,X
220 SHIPS = 6 - SKILL
225 HOME : VTAB 24: PRINT SHIPS" SHIP":; IF SHIPS = 1 THEN PRINT " LEFT
1": GOTO 230
227 PRINT "S LEFT"
230 IF INT ( RND (1) * (7 - SKILL)) = 1 THEN GOSUB 440
240 X = INT ( PDL (0) / 7.3): IF B < > X THEN GOSUB 380
250 IF PEEK ( - 16287) > 127 THEN CALL 768: GOSUB 280: GOTO 230
260 IF INT ( RND (1) * (7 - SKILL)) = 1 THEN GOSUB 440
270 GOTO 230
280 COLOR= 15:C = X
290 FOR I = 34 TO 0 STEP - 2
300 X = INT ( PDL (0) / 7.3): IF X < > B THEN GOSUB 380
310 FOR L = 1 TO 20: NEXT
320 COLOR= 15: VLIN I,I + 2 AT C + 2
330 COLOR= 0: PLOT C + 2,I
340 PLOT C + 2,I + 1: PLOT C + 2,I + 2
350 NEXT I
360 V(C + 2) = 1
366 COLOR= 14: VLIN 35,37 AT B + 2
370 RETURN
380 COLOR= 0: HLIN B,B + 4 AT 39: HLIN B,B + 4 AT 38: HLIN B + 1,B + 3 AT
37
390 VLIN 35,37 AT B + 2
400 B = X
410 COLOR= 14: HLIN B,B + 4 AT 39: HLIN B,B + 4 AT 38: HLIN B + 1,B + 3 AT
37
420 VLIN 35,37 AT B + 2
430 RETURN
440 IF INT ( RND (1) * 2) = 1 THEN 460
450 Y1 = INT ( RND (1) * 6) * 4 + 1:X1 = INT ( RND (1) * 9) * 4 + 3: GOTO
470
460 Y1 = INT ( RND (1) * 5) * 4 + 3:X1 = INT ( RND (1) * 8 + 1) * 4 + 1
470 Y1 = Y1 + 1: IF V(X1) = 0 THEN 490
480 GOTO 860
490 COLOR= 15
500 CALL 768: CALL 768
510 FOR L = Y1 TO 38 - SKILL STEP SKILL: VLIN L,L + SKILL AT X1
520 X = INT ( PDL (0) / 7.3): IF B < > X THEN GOSUB 380
530 NEXT
540 COLOR= 0
550 FOR L = Y1 TO 34 STEP 3: VLIN L,L + 4 AT X1: NEXT
560 IF SCRNI (X1,39) < > 0 THEN 590
570 COLOR= 0: VLIN Y1,39 AT X1
580 CC = 0: RETURN

```

(contin

Listing 1 (continued)

```

590 COLOR= 15
595 HOME
600 FOR A = 35 TO 39: HLIN X,X + 4 AT A: NEXT
610 COLOR= 0: HLIN X,X + 4 AT 35: CALL 768
620 HLIN X,X + 4 AT 36: CALL 768
630 HLIN X,X + 4 AT 37: CALL 768
640 HLIN X,X + 4 AT 38: CALL 768
650 HLIN X,X + 4 AT 39: CALL 768
655 IF SHIPS > 1 THEN PRINT "PRESS ANY KEY FOR NEXT SHIP ";; GET A$:SHI
PS = SHIPS - 1:X = INT ( PDL (0) / 7.3): GOSUB 390: GOTO 225
660 IF X < 5 THEN X = 5
670 IF X > 32 THEN X = 32
680 FOR V = 20 TO 23: VTAB V: HTAB X: PRINT "GAME";: CALL 768: HTAB X: PRINT
" ";; NEXT V
690 FOR L = 1 TO 4: VTAB 24: HTAB X - L: PRINT "GAME ";; CALL 768: NEXT

700 FOR V = 20 TO 23: VTAB V: HTAB X: PRINT "OVER";: CALL 768: HTAB X: PRINT
" ";; NEXT V
710 FOR L = 0 TO 3: VTAB 24: HTAB X + L: PRINT " OVER";: CALL 768: NEXT

720 PRINT : PRINT
730 PRINT "CARE FOR ANOTHER GAME? (Y/N): ";
740 GET G$: IF G$ = "N" THEN 770
750 IF G$ = "Y" THEN CLEAR : GOTO 20
760 GOTO 740
770 HOME : TEXT
780 I = 0
790 I = I + 1: VTAB I
800 FOR A = 39 TO 1 STEP - 1: HTAB A: PRINT ">";: HTAB A: PRINT " ";; NEXT
A
810 I = I + 1: VTAB I
820 FOR A = 1 TO 39: HTAB A: PRINT "<";: HTAB A: PRINT " ";; NEXT A
830 IF I < 20 THEN 790
840 VTAB 1: FOR I = 1 TO 20: VTAB I: HTAB 40: PRINT "~";: VTAB I: HTAB 4
0: FOR A = 1 TO 5: NEXT A: PRINT " ";; NEXT I
850 HOME : END
860 FOR CO = 3 TO 35 STEP 2: IF V(CO) = 0 THEN CC = 1: GOTO 440
870 X = INT ( PDL (0) / 7.3): IF B < > X THEN GOSUB 390
880 NEXT CO
890 CALL 768: CALL 769: PRINT "YOU WIN!"
900 GOTO 720
    
```

MICRO™

Interesting Software



presents

OSI C4P-MF SOFTWARE



THE MOST EXTENSIVE D&D ADVENTURE/FANTASY FOR THE OSI! YOU MUST TRAVEL THROUGH THE EVIL LANDS OF ISIERON, FIGHTING AND KILLING MONSTERS AND MAGIC-USERS EVERY STEP OF THE WAY! YOUR GOAL IS TO SEEK OUT CERTAIN TREASURES THAT WILL ALLOW YOU TO FREE THE LAND FROM THE EVIL CHAIN OF MAGIC CASTLES! COMPLETE WITH FULL GRAPHICS DISPLAY, COLOR AND SOUND!

INCLUDES A COMPREHENSIVE MANUAL, ALL THIS FOR ONLY.....\$29.95

SEND TO:
INTERESTING SOFTWARE
21101 S. HARVARD BLVD.
TORRANCE, CA 90501

SEND \$1 FOR OUR
CATALOG OF THE
FINEST OSI-C4P
MF SOFTWARE...

OHIO SCIENTIFIC

USERS!

READ . . .

PEEK (65)

The Unofficial OSI Users Journal

THE WORLD WIDE PUBLICATION
EXCLUSIVELY DEDICATED TO OSI USERS!

- Hardware Mods.
- Software Exchange
- Peeks and Pokes
- Software Reviews
- Bugs and Fixes

SEND \$15.00 FOR 12 ISSUES TO:

PEEK (65) P.O. BOX 347, OWINGS MILLS, MD 21117 (301) 363-3267

Maryland Subscribers Add 5% Tax

Inquire for Foreign Rates

Skyles Electric Works Presents

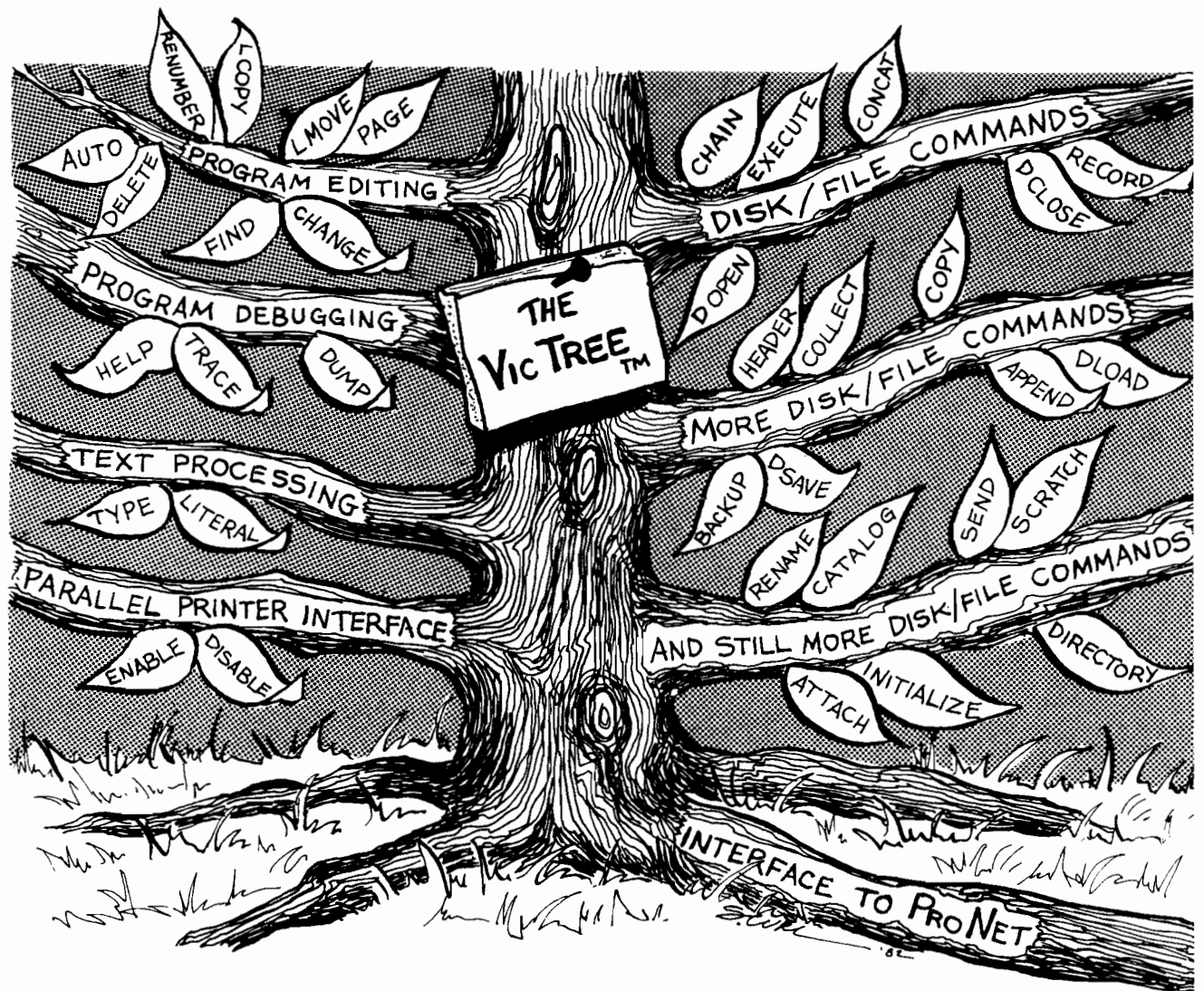

The VicTree™

- ...Leaves your new Vic (or CBM 64) with 35 additional commands.
- ...Branches out to most BASIC 4.0 programs.
- ...Roots into most printers.

New from Skyles: the VicTree, a coordinated hardware and software package that allows your Vic to branch out in unbelievable directions and makes it easier than ever to do BASIC programming, debugging and to access your disk. And the new VicTree provides routines to interface the Vic to the powerful ProNet local network. 8kb of ROM — 4kb for the BASIC commands, 4kb for disk commands and interfacing to ProNet — plus 4kb of RAM for miscellaneous storage. Perfect not only for the new Vic but also for the Commodore 64. Unbelievably simple to use and to install, the VicTree gives you all the additional BASIC 4.0 commands to allow most BASIC 4.0 programs to work on your new Vic or CBM 64.

Now only \$89.95...or \$99.95 complete with Centronics standard printer cable. (Cable alone \$19.95.) Available now from your local dealer or order through your Visa or MasterCard toll free (800) 227-9998 (California, Canada, Alaska, Hawaii: (415) 965-1735) or send check or money order directly to:



Skyles Electric Works

231E South Whisman Road
Mountain View, CA 94041
(415) 965-1735

MICRO™

PET Vet

By Loren Wright

What to Do with 96K — Two Word Processor Approaches

For the designers of Wordcraft Ultra and WordPro 5 Plus, it must have been a pleasant dilemma. Steve Punter and Pro-Micro Software had their popular WordPro 4 Plus to upgrade, while P.L. Dowson and DataView had the sleek Wordcraft 80 to work with. It is only logical that the extra memory provide more room for text, but it is what else has been added to the programs that makes them so interesting.

This column is devoted to a discussion of these two word-processing programs for the CBM 8096. Because these versions retain all the features of their predecessors, my discussion should be of use to people with 8032s, as well as to those with 8096s. A future PET Vet column will cover word processors for the 40-column PETs.

Wordcraft Ultra will run on an 8096, an 8032, or an 8032 expanded with Madison Computer's ZRAM board. WordPro 5 Plus is designed specifically for the 8096; it will not work with the 8032. Wordcraft versions require a special "data key" (formerly known as a "dongle"), while WordPro versions require a functional ROM in the \$A000 socket.

I will start with a general discussion of the two word processor families. Except where otherwise noted, Wordcraft refers to all the Ultra configurations and Wordcraft 80, while WordPro refers to WordPro 4 Plus and WordPro 5 Plus. I will also discuss the extra enhancements in the new versions.

The "Flavor" of WordPro

WordPro essentially presents you with a continuous scroll of 80-character lines on which to type. You start in the upper left-hand corner and keep typing until you're done. Words get split, but (not to worry) they will be kept together at output time. This, coupled with there being only two status lines, allows a lot of text to be viewed at once. Margins, centering, justification, paging, line spacing, and several other features are handled at output time. These are specified in the text

on special, non-printing format lines.

If you're working with elaborate tables or a particularly fancy text, the continuous nature of the text and the distracting format lines make it difficult to visualize what the result will look like. There is a special output-to-video command that will show you the results on the screen, without wasting paper, but editing must still be done on the original, continuous version, and this is time consuming.

WordPro has a special feature called "Extra Text," which may be used to hold other text files, disk directories, commonly used phrases and paragraphs, or files of names and addresses for filling form letters. In WordPro 5 Plus there are four such extra text areas. WordPros 3 and 4 have only one, but the relative sizes of the extra and main text areas can be apportioned differently for different needs. I used WordPro 5 Plus to write this column, primarily because of the "append characters" function. I stashed the names WordPro, WordPro 5 Plus, Wordcraft, and Wordcraft Ultra in extra memory, so that with only a few keystrokes I could copy those characters at the current cursor position. Whole paragraphs are handled in a similar manner. The extra text also makes it possible to have a whole file of names and addresses in memory at the same time as the target form letter.

The "Flavor" of Wordcraft

If you've used a big, dedicated word processor, you will be more comfortable with Wordcraft. With a few exceptions, what you see on the screen is what you get on paper. You can tell how lines will look before they are printed. Even documents wider than 80 columns can be handled. The screen is a window that can be panned across the text. If a really long word has been moved to the next line, leaving the previous one too short, you can easily tell where to insert a soft hyphen to even up the line lengths. Most format commands are indicated by the presence of reverse field on a text character, but they don't take up space on the screen. Instead of giving you a continuous scroll of lines, Wordcraft gives you a certain number of characters to work with. It forces new pages as needed according to your page-length specifications.

One powerful feature of Wordcraft is the ruler, which indicates the positions of your margins and tab stops. Its current contents are shown on the bottom status line (of five). The ruler may be changed at any time. If you're trying to get a table to look just right, you can try out one arrangement of tab stops, type in your text with tab characters at the right points, and then go back and readjust your ruler without reentering the text or the tab characters. The text will automatically line up at the new tab stops as soon as you finish changing the ruler.

A Comparison of WordPro and Wordcraft

Now that I have discussed the special features of Wordcraft and WordPro, I can compare them on what they have in common. Most word processors perform the following functions in some way. Some do them better than others.

Entry of Text: Both programs do a good job here. You can continue typing without worrying about the way words carry over to the next line. WordPro uses a simple carriage return to force a new line and the tab key to advance to the next tab stop. With Wordcraft, these must be preceded by the control key. The Commodore business keyboard, with its full cursor control, is well-suited to word processing.

Editing of Text: Both WordPro and Wordcraft have commands for deleting, inserting, transferring, and duplicating text. In general, Wordcraft's commands are more powerful, making cut-and-paste operations very easy. WordPro's delete, transfer, and duplicate commands have restrictions, which can be circumvented by inserting and deleting spaces. Insert mode with WordPro is more convenient.

Search and Search-and-Replace: Neither program excels at these functions. WordPro's command structure is complicated. The search-and-replace command is an all-or-nothing proposition. The search command finds the next occurrence of the search string, but requires a different command sequence to continue searching for the same string. Both commands can act globally or just on the current file, and there is an option to ignore case. Wordcraft's commands make more sense, but

PET Vet *(continued)*

there is no global option and delimiters (an artifact from line editors) are required around the search string. Both programs use the '?' as a "wild" character.

File Maintenance: WordPro makes this easy. It is possible to recall files using a few characters and an asterisk (the same as with other PET files). Also, file names can be read directly from the text area of the screen, such as from a comment line or directory listing. It is also possible to get a selective directory listing. When you have specified a file name that already exists, WordPro asks you if you want to replace it. Wordcraft, with its chapter organization and optional descriptive names and dates, makes documentation of the contents of a disk much more complete. However, saving and loading files is more cumbersome. Full file names must be typed in.

Support of Printers: WordPro fully supports a limited number of printers. It was designed specifically with the NEC Spinwriters in mind, and the combination works very well. The Diablo 630, Qume Sprint 5, CBM 8027, TEC 1500, and dot matrix types, are supported as well. However, other printers may not be fully supported. Wordcraft comes with a long list of printer data files, each matched to a particular printer/print wheel combination, on

the master disk. The Wordcraft dealer can obtain a PDF from the distributor for just about any printer that runs off the IEEE. Wordcraft Ultra has special features for supporting printers with proportional spacing print wheels.

Generation of Form Letters: Wordcraft's handling of these is more powerful. The fields in the letter have unique identifiers, so that the same piece of information from the fill file may be reused. This avoids a lot of extra typing when you construct the fill file. However, the fill file must be used from the disk, and while entries may be used selectively, it is difficult to remember which page numbers go with which entries in the file. This makes editing difficult. WordPro, with its extra memory feature, allows the fill file and the form letter to be in memory at the same time, making editing much easier. Blanks in the form letter are filled sequentially, so if the same item has to be reused in the letter it must appear twice in the fill file. Selective use of entries from the fill file is also more difficult.

Handling of Long Files: WordPro has a chaining feature that allows a document to extend beyond the capacity of the computer. Print, search, search-and-replace, copy, and output-to-video commands can all be specified with global options. A global command will operate not only on the file in

memory, but also on all the files linked to it and stored on disk.

Wordcraft, instead of chaining files, uses a "chapter" organization. To continue a file, save the first as chapter 1, then assign the continuation to chapter 2 of the same file. Files may be printed out globally, or by specifying a certain range of chapter numbers. Also, individual pages may be selected. However, commands such as search, search-and-replace, and copy act only on the chapter in memory.

What's Been Added?

Wordcraft's text size has been approximately doubled, from about 11,000 characters in Wordcraft 80 to over 20,000 in Wordcraft Ultra. Wordcraft 80 requires the master disk to be present in one drive, since the editor and print module could not reside in memory at the same time. With Wordcraft Ultra the entire program resides in memory at one time, leaving both drives available for file operations. (The 8032 configuration requires a ROM, which contains program modules.) Wordcraft Ultra adds a set of escape codes that provide such capabilities as selective double-spacing and centering or right alignment of a series of lines. Other escape codes handle

(continued)

UPGRADE YOUR AIM-65* INSTANTLY

*A trademark of Rockwell Inc.

To A 6809 Development System

With The

"MACH-9"

From

M M S Inc.

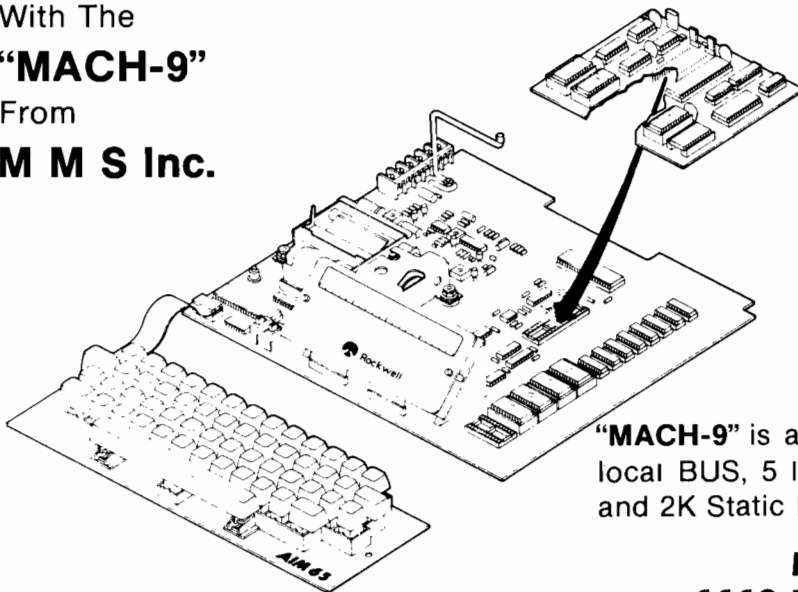

INTRODUCTORY PRICE

\$239.

Plus \$6 U.P.S.
And Handling

Includes:

- *6809 CPU Plug-in Assembly
- *Super-set of AIM Monitor
- *Two-Pass Symbolic Assembler
- *Complete Monitor Source Listings
- *Enhanced Cut & Paste Editor
- *200 Page Manual
- *Full I/O Control

"MACH-9" is assembled and tested with local BUS, 5 locking low force ROM sockets and 2K Static RAM

M M S Inc.
1110 E. PENNSYLVANIA ST.
TUCSON, AZ 85714
(602) 746-0418



PET Vet *(continued)*

pitch, vertical spacing, horizontal spacing, and proportional spacing. Unfortunately, these non-printing characters occupy space on the screen, making it a less accurate representation of what will be printed. Also added is support of Canadian Micro Distributing's MUPET multiple-user system. Wordcraft Ultra also has its own built-in multiple user system. Another big improvement is the provision to handle proportional spacing print wheels. The price of Wordcraft 80 is \$395, while that of Wordcraft Ultra is \$545.

WordPro 5 Plus includes the main and four extra text areas, each containing 169 80-character lines. Therefore, the maximum length of a single file in memory has not increased from WordPro 4 Plus to WordPro 5 Plus, but then neither has the price (both \$450). WordPro 5 Plus has added support of the MUPET system, as well. I have just barely begun to explore the possible uses of the extra text areas.

Conclusions

With the possible exception of the IBM PC, the CBM 8032/8096 has the best keyboard for microcomputer business applications. Easy cursor control, built-in screen editing, and the separate numeric keypad all con-

tribute. Dedicated word processors have many special keys on the keyboard for all the things a word processor has to do. A microcomputer keyboard has to be used for applications besides word processing, so it can't afford the luxury of all the extra keys. Both programs take advantage of what the computer has to offer.

Overall, I rate Wordcraft as a more powerful word processor. However, WordPro is much easier to learn. If you don't use Wordcraft every day, you will find yourself frequently looking things up, even if you learned it thoroughly the first time around. Beyond that, it really depends on what you want to do. If you plan to do a lot of "boiler-plateing" (putting a document together using standard phrases and paragraphs) then you will find WordPro easier to use. If you're working on a really long document, such as a book, then the chapter organization of Wordcraft will be handy. For full control of a variety of letter-quality printers, for tabular material, and for material wider than 80 columns, Wordcraft has the edge. A big point in WordPro's favor is that it is (in its many versions) already the most popular word processor on the market for Commodore systems. This means that it is easier to exchange files with other people and that commercial programs, such as spelling checkers and

data-base managers, will be written for WordPro first.

When you consider word processors for the 8096 you shouldn't forget Silicon Office — a combination word processor, data-base manager, and communications package. Contributing Editor Jim Strasma covered it in a full-length review in MICRO's June issue. He was particularly impressed with the word processor portion. It can handle long files much better (the whole disk!), can handle multiple-column documents, and can perform calculations using information from the data base. The \$995 price is out of the range of the word processors covered here, but if you need a data-base manager, too, be sure to give Silicon Office a lot of consideration.

WordPro is distributed to dealers by Professional Software, Inc., 51 Fremont Street, Needham, MA 02194. Wordcraft 80 and Wordcraft Ultra are distributed to dealers by Computer Marketing Services, Inc., 300 W. Marlton Pike, Suite 26, Cherry Hill, NJ 08002.

Special thanks to Jim Lucivero of NEECO in Needham, MA, for the use of letter-quality printers used in this review.

MICRO

ANNOUNCING A NEW JOURNAL

DEVOTED TO ALL ASPECTS

OF MICROCOMPUTER

USE AT THE

UNDERGRADUATE

LEVEL

PREMIER

ISSUE

FEBRUARY 1983

write:

Collegiate Microcomputer

Rose-Hulman Institute of Technology

Terre Haute IN 47803 USA

Prospectus sent upon request.

OSI Disk Users

**Double your disk storage capacity
Without adding disk drives**

Now you can more than double your usable floppy disk storage capacity—for a fraction of the cost of additional disk drives. Modular Systems' DiskDoubl™ is a double-density adapter that doubles the storage capacity of each disk track. The DiskDoubl plugs directly into an OSI disk interface board. No changes to hardware or software are required.

The DiskDoubl increases total disk space under OS-65U to 550K; under OS-65D to 473K for 8-inch floppies, to 163K for mini-floppies. With the DiskDoubl, each drive does the work of two. You can have more and larger programs, related files, and disk utilities on the same disk—for easier operation without constant disk changes.

Your OSI system is an investment in computing power. Get the full value from the disk hardware and software that you already own. Just write to us, and we'll send you the full story on the DiskDoubl, along with the rest of our growing family of products for OSI disk systems.

™DiskDoubl is a trademark of Modular Systems.

Modular Systems

Post Office Box 16C
Oradell, NJ 07649.0016
Telephone 201 262.0093

Now . . . The Ultimate In Wordprocessing For The Commodore Computer. **WORDCRAFT ULTRA!**

Wordcraft ULTRA™ turns your Commodore microcomputer into one of the world's most advanced word processing systems, incorporating features previously found only in systems priced thousands of dollars higher!

- True proportional spacing with inter-character and inter-word spacing!
- Multi-user with up to 8 CPU's sharing one or more disk drives and printers with no extra hardware required other than a cable!
- Screen layout matches the printed document! You'll love the "what you see is what you get" feeling.
- Continuous centering, delete and insert, movement of text, search and replace, tab and indent, bold print and underline . . . a seemingly endless list of features designed to make text editing as simple and complete as possible!
- Wordcraft ULTRA runs on the CBM 8032, 8096 or Madison Computer's Z-RAM™ board. The Z-RAM Board not only expands your computer to 96K but also adds CP/M™.

Why settle for less when you get so much more with Wordcraft ULTRA on the Commodore Computer!

**Contact Your Nearest Commodore Dealer Today . . .
You'll Be So Glad You Did!**

In The East Call:
**COMPUTER
MARKETING SERVICES INC.**
300 W. Marlton Pike, Suite 26
Cherry Hill, New Jersey 08002
(609) 795-9480

In The West Call:
**CIMARRON
CORPORATION**
666 Baker Street, Suite 319
Costa Mesa, California 92626
(714) 641-1156

Z RAM is a trademark of Madison Computer
CP/M is a trademark of Digital Research
Wordcraft Ultra is a trademark of Dataview Ltd

Apple Hi-Res Graphics and Memory Use

by Dan Weston

This article examines the conflicts of programs and hi-res graphics on the Apple II, plus several techniques to avoid these conflicts.

Hi-Res
requires:
Apple II with 32K

When you begin to write long programs that use the hi-res pages of the Apple II, you will overwrite the graphic display area if your program and variables are longer than 6K. There are many ways to get around this problem, which involve manipulating the pointers Applesoft uses to control memory usage. Here I discuss several methods for making the most of your computer's memory.

Normally a BASIC program is loaded beginning at memory location \$800 (2048). The program fills memory upwards from \$800. LOMEM is set to the end of the program and will change as the program changes.

Simple variables are stored from LOMEM upward as they are defined by the program. Arrays are stored from the end of simple variables upward. An addition to the simple variable space will push the array variables upward with no loss of integrity. Finally, string variables are stored from the top of available memory, HIMEM, downward in memory, with new strings being placed in successively lower memory locations. The pointers that guide the placement of variables are summarized in figure 1, and will be discussed later in this article.

The problem with this storage scheme is that the hi-res pages are located between the program and the

end of memory. Hi-res page 1 display area sits between \$2000 and \$4000 (16384-24575), and hi-res page 2 sits from \$4000 to \$6000 (24576-32758). There is a 6K block of memory between \$800 and the beginning of hi-res page 1. If your program is longer than 6K and invokes HGR, you will find that the last portion of your program has been wiped from memory. Even with programs shorter than 6K, an HGR call can wipe out arrays and variables that are stored above the program.

To avoid this problem, set LOMEM

at the upper end of the hi-res page (1 or 2), so that simple variables and arrays will be stored above the hi-res area rather than across it. This method requires that the program be less than 6K, and that the LOMEM statement come before any variables are defined. LOMEM: 16384 will store variables above hi-res page 1. LOMEM: 24576 will store variables above hi-res page 2.

Another method is to put graphics on hi-res page 2 instead of page 1. This frees the 8K bytes of the first hi-res page for program and variable storage, giving

Figure 1: Applesoft Memory and Variable Pointers

Pointer Name	Hex	Dec	Normal Setting	Special Effects
Beginning of Applesoft program	\$67	103	program loads at \$800	POKE 103,1 : program loads
	\$68	104		POKE 104,64 : above hi-res
LOMEM beginning of simple variables	\$69	105	end of current program	POKE 16384,0 : page 1
	\$6A	106		POKE 103,1 : program loads
				POKE 104,96 : above hi-res
End of simple variables	\$6B	107	adjusts with size of variable table	POKE 24576,0 : page 2
	\$6C	108		POKE 105,1 : put variables
End of array variables	\$6D	109	adjusts with size of variable table	POKE 106,64 : above hi-res
	\$6E	110		POKE 106,8 : page 1
End of string variables	\$6F	111	adjusts with size of string table	POKE 105,0 : LOMEM at \$800
	\$70	112		POKE 106,8 : below hi-res
HIMEM beginning of string data	\$73	115	top of usable memory, low end of DOS buffers	POKE 107,0 : simple
	\$74	116		POKE 108,8 : variables
				POKE 109,0 : array
				POKE 110,8 : variables
				POKE 111,0 : strings put
				POKE 112,32 : below hi-res
				POKE 112,32 : page 1
				POKE 115,0 : HIMEM at
				POKE 116,32 : \$2000, below
				POKE 116,32 : hi-res page 1

Listing 1

```

100 HOME : PRINT "VARIABLE POINTER CHANGE TEST"
110 PRINT : PRINT : INVERSE : PRINT "BEFORE MOVE": NORMAL : PRINT : PRINT

120 GOSUB 1000: REM PRINT POINTER LOCATIONS
130 GOSUB 1300: REM CHANGE POINTERS
140 GOSUB 1200: REM DECLARE VARIABLES
150 GOSUB 1400: REM RETRIEVE VARIABLES
200 END
1000 REM PRINT POINTER LOCATIONS
1005 PRINT PEEK (103) + 256 * PEEK (104);" PROGRAM BEGINNING"
1010 PRINT PEEK (105) + 256 * PEEK (106);" LOMEM,VARIABLES START"
1020 PRINT PEEK (107) + 256 * PEEK (108);" END OF SIMPLE VARIABLES"
1030 PRINT PEEK (109) + 256 * PEEK (110);" END OF ARRAYS"
1040 PRINT PEEK (111) + 256 * PEEK (112);" END OF STRINGS"
1050 PRINT PEEK (115) + 256 * PEEK (116);" HIMEM,START OF STRINGS"
1090 RETURN
1200 REM DECLARE SOME VARIABLES
1210 A = 3:B = 6:C% = 7
1220 A$ = "LLLLLLLLLLL":B$ = "UUUUUUUUU"
1225 PRINT : PRINT
1230 INPUT "NEW STRING?";C$
1232 PRINT : PRINT
1235 DIM X(1,1,1)
1240 PRINT : PRINT : INVERSE : PRINT "AFTER VARIABLES DEFINED": NORMAL :
PRINT : PRINT
1250 GOSUB 1000
1290 RETURN
1300 REM CHANGE POINTERS
1310 POKE 105,1: POKE 106,8: REM LOMEM
1320 POKE 107,1: POKE 108,8: REM SIMPLE VAR END
1330 POKE 109,1: POKE 110,8: REM ARRAYS
1340 POKE 111,255: POKE 112,31: REM STRINGS
1350 POKE 115,255: POKE 116,31: REM HIMEM
1360 PRINT : PRINT : INVERSE : PRINT "AFTER POINTER CHANGE": NORMAL : PRINT
: PRINT
1370 GOSUB 1000
1390 RETURN
1400 REM TEST FOR VARIABLE RETRIEVAL
1410 PRINT : PRINT : INVERSE : PRINT "VARIABLE RETRIEVAL": NORMAL : PRINT
: PRINT
1420 PRINT "A=";A
1430 PRINT "B=";B
1440 PRINT "C%=";C%
1450 PRINT "A$=";A$
1460 PRINT "B$=";B$
1465 PRINT "C$=";C$
1470 RETURN

```

you an effective program space of 14K, instead of the 6K you would have if you used page 1. To use page 2, just use HGR2 instead of HGR.

But there are some problems with this method. First of all, you cannot use the four lines of text below the graphics screen with HGR2. This will not be a problem if you are using some sort of hi-res character generator like the DOS TOOL KIT's HRCG. The other problem is that you may want to use both of the hi-res pages, say for page-flipping. In this case you would be back to the original 6K limitation.

The next method that might be useful is to relocate the program above the hi-res page (or pages). This is done by POKEing values into the memory locations that Applesoft looks at to see where to LOAD or RUN a new program. These POKEs must be done before the program is loaded or run, say from a "hello" program. Here are the POKEs:

```

to load above page 1
POKE 103,1
POKE 104,64
POKE 16384,0 : REM A 0 MUST BE
PLACED IN MEMORY
JUST AHEAD OF WHERE
THE PROGRAM WILL
LOAD
to load above page 2
POKE 103,1
POKE 104,96
POKE 24576,0

```

If the program is loaded above page 1 you will have about 22K (in a 48K system) for the program and variables. If you load above page 2, you will have about 14K. The 6K of memory below page 1 (\$800-\$2000) will remain unused by Applesoft.

Once you have loaded your program above a hi-res page you will probably want to figure out some way to use the memory that is just sitting empty below page 1. Again, there are several

options. Here are just a few:

1. You can locate shape tables, especially long tables that will not fit at location \$300, below the hi-res page, beginning at \$800. The table can either be POKEd into that memory range or BLOADED at \$800. Then the pointers at 232 and 233, which tell Applesoft the location of the current shape table, should be POKEd to point to this location. You could put several tables below page 1 and change the pointers as the program used one or another of the tables.
2. The DOS TOOL KIT's high-resolution character generator (HRCG) can be forced to load below page 1 by modifying the LOADHRCG program from the TOOL KIT. Insert the statement ' HIMEM: 8190 ' in the LOADHRCG program just before the step that says ' PRINT CHR\$(4); "BLOAD RBOOT" '. RBOOT uses HIMEM to determine where to load the character generator. By giving a value of 8190 for HIMEM, the program is fooled into putting the character generator below page 1, rather than at the top of memory. You must insert one more step in the LOADHRCG program: ' HIMEM: 38400 ' is needed to reset HIMEM to the top of memory, just below the DOS buffers. This step should come after the step that reads ' CALL ADRS: REM INITIALIZE HRCG '. The value you use to reset HIMEM will depend on the size of your system; the value given is for a 48K Apple. Check the DOS manual for the figures for other size systems.
3. If you are writing a very large program that uses lots of variables, especially arrays, you may find that the variables will overwrite the strings, or *vice versa*, and then you have problems. Applesoft uses a set of pointers that tell the program where to store variables as they are encountered. If you change the pointers you can fool the program into using the memory below page 1 for variable storage, thus freeing room at the top of memory for your program.

See the chart in figure 1 for a more complete description of the pointers. Here are the POKEs that will cause a program loaded above the hi-res area to place its variables in the memory between \$800 and \$2000. Note: *These POKEs must be done before any variables are used by the program.*

```

POKE 105,0
POKE 106,8 : REM LOMEM AT $800
POKE 107,0
POKE 108,8 : REM SIMPLE VARIABLES
ENTERED AT $800

```

Listing 2

]RUN LISTING 1
VARIABLE POINTER CHANGE TEST

BEFORE MOVE

16385 PROGRAM BEGINNING
17481 LOMEM, VARIABLES START
17481 END OF SIMPLE VARIABLES
17481 END OF ARRAYS
38400 END OF STRINGS
38400 HIMEM, START OF STRINGS

AFTER POINTER CHANGE

16385 PROGRAM BEGINNING
2049 LOMEM, VARIABLES START
2049 END OF SIMPLE VARIABLES
2049 END OF ARRAYS
8191 END OF STRINGS
8191 HIMEM, START OF STRINGS

NEW STRING? ANYSTRING

AFTER VARIABLES DEFINED

16385 PROGRAM BEGINNING
2049 LOMEM, VARIABLES START
2091 END OF SIMPLE VARIABLES
2142 END OF ARRAYS
8182 END OF STRINGS
8191 HIMEM, START OF STRINGS

VARIABLE RETRIEVAL

A=3
B=6
C#=7
A\$=LLLLLLLLLLLL
B\$=UUUUUUUUUU
C\$=ANYSTRING

]

POKE 109,0
POKE 110,8 : REM ARRAY VARIABLES
ENTERED AT \$800

POKE 111,0
POKE 112,32 : REM STRINGS ENTERED
AT \$2000

POKE 115,0
POKE 116,32 : REM HIMEM AT \$2000

These values are adjusted dynamically by Applesoft as variables are encountered. This is why many of the pointers are set to the same value initially. You may want to set the pointers differently to allow room below hi-res page 1 for some of the shape tables or routines that were discussed in the first part of the article. Play around with the values until you can use as much of the Apple's memory as possible.

Listing 1 tests the use of these pointers. The program must be loaded above one of the hi-res pages, as discussed earlier. The program displays the pointer values before any manipulation, after they are lowered, and finally after a selection of variables is defined by the program. Listing 2 is the output of this program. It shows how the variable pointers are high, above the program, then shift low, below hi-res page 1, then adjust with the definition of variables.

Once these values are set this way, attempts to add lines to the program will result in an "OUT OF MEMORY" error, because HIMEM is lower than the end of the program. Otherwise, the program should run normally and the memory manipulations will be transparent to the user.

I cannot hope to have covered all the tricks that can be used to get the most out of your Apple, but I hope that the ideas I have put forward will allow you to do some exploring and manipulating on your own.

References:

1. Applesoft Basic Programming Reference Manual, Apple Computer Co., 1978, pp 127, 137, 140.
2. Lechner and Worth, Beneath Apple DOS, Quality Software, 1981, pg. 8-42.
3. Wagner, "Assembly Lines, Part 17," Softalk, February, 1982.

Dan Weston is currently teaching a self-contained eighth grade in Brooks, Oregon. Contact Mr. Weston at 195 23rd NE, Salem, OR 97301.



Our Current Best-Seller

MICRO
on the Apple
Volume 3 INCLUDES DISKETTE



\$24.95*

More than 40 new programs on diskette to help you get more from your Apple:

- Machine-Language Aids
- I/O Enhancements
- Applesoft Aids
- Graphics and Games
- Reference Information

19 choice articles
43 tested programs on diskette
(16 sector DOS 3.3 format)

Volumes 1 & 2 also available at \$24.95*

Together **MICRO on the Apple 1, 2, & 3** provide more than 110 programs on diskette for less than \$1.00 each. No need to type in hundreds of lines of code.

MICRO makes it easy to order:
Send check (payable to MICRO) to:

MICRO INK
P.O. Box 6502
Chelmsford, MA 01824

Call our toll-free number:

1-800-345-8112

(In PA, 1-800-662-2444)

VISA and MasterCard accepted

Also available at your local computer store.

*Add \$2.00 shipping per book.
MA residents add 5%.

Atari Character Graphics from BASIC, Part 2

by Paul Swanson

The author adds fine scrolling to his character animation program, and introduces programming ANTIC's display list.

Character Graphics II requires:

Atari 400/800

Last month (53:84) I showed you a very simple method for using a custom character set in BASIC. The amount of memory saved by using character graphics instead of map-mode graphics is substantial. A mode 7 screen would normally use almost 4K of memory. Replacing it with character graphics requires ½K for the character set plus about 240 bytes for the 20 × 12 character screen, for a total of about 770 bytes.

Of course, character graphics does have its drawbacks. For example, how do you move an image across the screen without having it "jump" from one character position to the next? The normal ways to put characters on the screen don't offer many alternatives. You could invent additional characters to mimic the movements. All that involves a lot of programming and many characters for each figure on the screen.

Are character-graphics screens dedicated to only those applications where nothing on the screen moves unless you introduce a player or missile? Are they just to display a pretty background for your program?

ANTIC

Fortunately, you have an Atari computer. The Atari has not one, but two microprocessors you can program. The Atari has one processor, a 6502, which functions as the "brain" of the system. It has another, called ANTIC, that controls just the screen display.

ANTIC's language is a machine language, which means it is all numbers, but the language is easy to learn because there are only a few instruc-

tions. Its program is called a display list. Each instruction does something on the screen taken in order from the top of the screen to the bottom.

ANTIC's program usually starts with "blank 8 lines" instructions, using three of them so that the displayed images are all visible on the screen. Televisions are set up with "overscan," which means that part of the actual picture is off the screen in all four directions so that the movies and commercials won't have borders around them. On the computer, you usually want to see the whole screen, so the borders are not so annoying.

Once you have the blank lines out of the way, you need an instruction called a Load Memory Scan (LMS) instruction, which tells ANTIC where the next line is in memory that you want displayed. This command is three bytes long. The first byte is the LMS instruction and the next two define the memory location.

If you continue using LMS instructions for each line on the screen, you can put every line on the screen in a different part of memory. This is not usually done. Instead, you can follow an LMS instruction with a Mode Line instruction, which tells ANTIC to keep incrementing the memory "pointer" for each consecutive line.

The last instruction in the display list is the "Jump on Vertical Blank" (JVB) instruction. A JVB tells ANTIC to wait until the television picture is completed, which is the end of a sixtieth-of-a-second cycle, then "jump" to the location it has in the two bytes that follow the JVB. The LMS and the JVB are both three-byte instructions. The Blank Line and Mode Line instructions are both one byte long.

All of this may mean very little to you without an example. To put an example together with the numbers in decimal would also mean very little because ANTIC interprets them in binary. Hexadecimal is a good compromise. In hexadecimal and decimal, the following is the program for ANTIC that BASIC sets up in response to a

GRAPHICS 18 statement (mode 2 without a text window):

Hex	Decimal	Instruction
70	112	Blank 8 lines
70	112	
70	112	
47	71	LMS ANTIC mode 7, = BASIC mode 3, plus 2-byte memory location. Display ANTIC mode 7
xx	xx	
xx	xx	
07	7	
07	7	JVB
07	7	
07	7	
07	7	
07	7	
07	7	
07	7	
07	7	
07	7	
41	65	
xx	xx	
xx	xx	

As you can see, the ANTIC numbers for the modes are not the same as the BASIC numbers for the modes. As you become more familiar with display lists, you will find that there are more modes available than the few that BASIC allows. For this example, you need to know that BASIC's mode 2 is ANTIC's mode 7.

So, what has all this to do with moving characters around on a character-graphics screen? If there is nothing more to gain than being able to see what ANTIC's program looks like, then this looks like a mildly educational exercise, right? Read on.

Fine Scrolling

ANTIC has a few more little twists to it than just displaying normal characters on the screen, or even modified characters. It has fine scrolling capabilities, both horizontally and vertically. To use them, you must set the "mode-

line" instruction of each line in the display list that corresponds to the line you want to be able to scroll. That's why you need to know what the display list looks like.

Fine scrolling allows you to move the entire character row (or all of the rows if you like, which is what the program at the end of this article does) one dot at a time horizontally and/or vertically. Using a combination of fine scrolling and moving the entire character a whole character position will allow you to move a character display smoothly.

To see how to enable the fine scrolling function, you must first take apart the two instructions that result in a line on the display. In hexadecimal, for an ANTIC mode 7 display, these instructions are the LMS instruction, 47, and the mode-line instruction, 07. In binary, these are 0100 0111 and 0000 0111. Using the numbering that makes the leftmost binary digit number 7 and the rightmost one number zero, the binary digits we want are numbers 4 and 5. Number 4 enables horizontal scrolling: 0101 0111 and 0001 0111. Number 5 enables vertical scrolling: 0110 0111 and 0010 0111. Setting both to one enables both: 0111 0111 and 0011 0111.

To use these from BASIC, we need the decimal equivalent. To enable horizontal and vertical scrolling, add decimal 48, which is binary 0011 0000. That changes the LMS from 71 to 119 and the mode-line instruction from 7 to 55. In decimal, the final display list for a GRAPHICS 18 screen would be: 112 112 112 119 xx xx 55 55 55 55 55 55 55 55 55 55 65 xx xx, where xx stands for a memory location not yet determined.

Special Memory Locations

Now that we know what to do with the display list, where do we find it? There are special memory locations in the Atari that can give us, or accept from us, all kinds of information. For example, locations 560 and 561 contain the location of the start of the display list. If we declare a GRAPHICS 18 screen in a program, then set a variable to `PEEK(560)+PEEK(561)*256`, that variable will have the location of the display list ANTIC is using. You can write a new location to 560 and 561 if you form one on your own, but it is usually easier to just modify the one BASIC has already set up.

In the program, we can find the display list, then modify all the instructions that display a line on the screen by adding 48 to it. That will enable the scrolling we want. We also need a few other special locations. Two locations are required to put the amount of

```

1 REM *** Custom Character Set ***
2 REM *** Program for Part II ***
3 REM
4 REM
5 REM *** Program by...      ***
6 REM ***      Paul S. Swanson ***
7 REM
8 REM
9 REM --- Calc. position in mem. ---
10 DIM S$(1024)
20 A=ADR(S$)
30 B=INT(A/512+1)*2
40 CBASE=B*256-A+1
47 REM
48 REM
49 REM --- Clear S string ---
50 S$(1)=CHR$(0)
60 S$(1024)=CHR$(0)
70 S$(2)=S$(1)
77 REM
78 REM
79 REM --- Move standard set down ---
80 FOR I=0 TO 511
90 S$(CBASE+I,CBASE+I)=CHR$(PEEK(I+57344))
100 NEXT I
107 REM
108 REM
109 REM --- Set # to character ---
110 FOR I=24 TO 31
120 READ N
130 S$(I+CBASE,I+CBASE)=CHR$(N)
140 NEXT I
147 REM
148 REM
149 REM --- GR.2 - No text window ---
150 GRAPHICS 18
157 REM
158 REM
159 REM --- Find Display List ---
160 DLIST=PEEK(560)+PEEK(561)*256
162 SLOC=PEEK(DLIST+4)+PEEK(DLIST+5)*256
167 REM
168 REM
169 REM --- Set scroll enables ---
170 POKE DLIST+3,PEEK(DLIST+3)+48
180 FOR I=6 TO 16
190 POKE DLIST+I,PEEK(DLIST+I)+48
200 NEXT I
207 REM
208 REM
209 REM --- Initialize position ---
210 VPOS=95
220 HPOS=80
222 POKE 756,B
224 WING=1
226 S=14
227 REM
228 REM
229 REM --- Draw character in position ---
230 V=INT(VPOS/16)
232 IF WING=1 THEN SOUND 0,10,0,6
240 VSCROL=VPOS-V*16
250 H=INT(HPOS/8)
260 HSCROL=HPOS-H*8
262 IF WING=1 THEN WING=2:S$(CBASE+25,CBASE+25)=CHR$(0):S$(CBASE+26,
    CBASE+26)=CHR$(231):GOTO 266
264 WING=1:S$(CBASE+25,CBASE+25)=CHR$(195):S$(CBASE+26,CBASE+26)=CHR$(36)
266 POKE 559,0
270 POKE SLOC+P,0:P=V*24+H:POKE SLOC+P,3
280 POKE 54276,HSCROL
290 POKE 54277,15-VSCROL
292 POKE 559,34
294 SOUND 0,10,0,2
297 REM
298 REM
299 REM --- Read Joystick ---
300 OLDS=S:S=STICK(0)
310 IF S=15 THEN S=OLDS
320 VMOVE=0
330 HMOVE=0
340 IF S=9 OR S=13 OR S=5 THEN VMOVE=2
350 IF S=10 OR S=14 OR S=6 THEN VMOVE=-2
360 IF S>4 AND S<8 THEN HMOVE=1
370 IF S>8 AND S<12 THEN HMOVE=-1
380 IF VMOVE+VPOS>=0 AND VMOVE+VPOS<191 THEN VPOS=VPOS+VMOVE
390 IF HMOVE+HPOS>=0 AND HMOVE+HPOS<192 THEN HPOS=HPOS+HMOVE
400 IF VMOVE=2 THEN WING=2
410 GOTO 230
1000 DATA 0,195,36,24,24,36,0,0

```

POSITION statements do not work when you enable the scroll because ANTIC automatically assumes a "wide playfield" instead of a normal one, which has 24-character lines instead of 20-character lines. That is why the formula $P = V * 24 + H$ is required. The variable P will be the "old" position for the next loop, so that you don't have to calculate anything to erase the old figure before you POKE the new one into place.

Lines 280 and 290 set the horizontal and vertical values into the special memory locations reserved for them. Note that the vertical scroll value runs in the opposite direction and must be subtracted from its maximum value, 15, to get the correct one. When these values are POKEd, ANTIC is turned back on by POKEing 34 into location 559, as is done in line 292. Line 294 stops the "wing-flapping" sound and, like line 232, is positioned here for the sake of timing the sound.

Now that we have all of the statements in place for moving the figure around, we need some way to control where it moves. I chose the joystick for input. It is read at line 300. Line 310 causes all readings where the stick is in the "neutral" position to be ignored. These two statements will use the last non-neutral position for the direction, if the joystick is centered.

When you move the joystick, lines 320 through 390 interpret the movement into the new position by updating VPOS and HPOS. The vertical movements are all 2 dots at a time to compensate for the difference in the two dimensions so that the bird will fly up at about the same rate as it will fly horizontally. Lines 380 and 390 make sure the figure stays on the screen, then line 400 goes back to put the figure where you just moved it. Line 1000 is the character shape for the READ at line 120.

Now you can RUN the program and move the figure around the screen with your joystick. If you don't have a joystick, you should be able to figure out how to move it with the four arrow keys.

Notice that the figure does flash a little when you move it. This happens when you turn ANTIC off. This can be limited by decreasing the delay (line 270) after you turn ANTIC off. Remember that line 270 does not require that ANTIC be off, so it functions as the delay. You can shorten the delay as much as you like until you start getting snow on the screen when you move the figure horizontally. You can do this by breaking the line up so that the first statement executes before the POKE 559 statement. This snow is the problem you avoid by turning ANTIC off.

Note that I did include a few statements in the program that weren't described. These statements are set up to cause the bird to flap its wings when it is moving horizontally or up (i.e., VMOVE does not indicate "down"). When the bird moves downward, the wings do not flap and the flapping sound stops.

The program is not the most efficient way to scroll character-graphics screens, but it does show the general idea of how it is done. You can make the program more efficient by doing things like replacing the part that reads and interprets the joystick with a faster routine. You may develop a different way of handling the positions from the VPOS and HPOS approach. If you keep the character position and the scroll values separately, you will not need the two divisions. If you do it right, you can gain some speed there. Remember that the program was written to be instructional rather than efficient, so you should find many areas where you can speed up.

Play around with the program until you get ideas on how to use character graphics for your own programming project. Your own project will familiarize you with the advantages of character graphics. Remember, too, that you are saving lots of memory.

MICRO

OSI SOFTWARE

Challenger 1P

Superboard II

HEXDOS is a remarkable disk operating system which surpasses the capabilities of OS65D. But because HEXDOS uses subroutines in OSI's ROM BASIC, it is very compact (only 2K). HEXDOS provides you with easy-to-use commands and saves 10K of memory and disk space!

- Load or save BASIC programs, machine language, and data files by name. Chain BASIC programs from disk.
- Up to 22 data files may be open simultaneously.
- Resides at the beginning of RAM, leaving maximum space for user programs.
- Full trace of BASIC programs with optional single-stepping.
- True line editing allows you to correct mistakes easily.
- Supports random-access data files, real-time clock, and tone generator.
- Includes a disassembler and demonstration programs: CHECKBOOK and ADDRESSBOOK (personal data base management), LIFE, SURROUND, REVERSI, BACKGAMMON, and BSR CONTROLLER (home control).
- Satisfaction guaranteed, or your money promptly refunded.

"Documentation is clear and complete, the best I have seen from any source."

— Ronald C. Whitaker, **Compute!** magazine, April 1981

Price: \$49.50 (5¼-inch diskette and 40-page manual)

HEXASM is a powerful macro-assembler which supports conditional assembly, linked source files, symbol tables, and user-defined macros. Designed to replace OSI's considerably less powerful assembler. Also included: a simple editor for text files, a utility to renumber BASIC programs, and a disk tester/copier. Requires HEXDOS and 20K RAM.
Price: \$38.50 (diskette and manual)

TEC65 is an OSI version of DEC's popular TECO editing language. TEC65 allows you to perform complex editing tasks and major text reorganization with simple command strings. Right justification and title centering options for word processing. Requires HEXDOS.
Price: \$38.50 (diskette and manual)

FOCAL-65 is an implementation of DEC's unique programming language. With 9-digit floating-point arithmetic and transcendental functions, FOCAL-65 is especially suited for mathematical and scientific programs. Easy to learn and program. Requires HEXDOS and 16K RAM.
Price: \$66.00 (diskette and two manuals)

Your satisfaction guaranteed, or your money promptly and completely refunded. For more information, send \$1.00 for our catalog of OSI, Apple, AIM, KIM, and SYM software.



The 6502 Program Exchange

2920 W. Moana, Reno, NV 89509



Apple Slices

By Tim Osborn

This month's column discusses one of the fundamental elements of any computer system, the block move. I also present a subroutine to perform block moves. If you find yourself saying "but the monitor already includes a block-move routine," read on; I'll show you why you may want to use my block move instead. I'll also show you why it is sometimes advantageous to use the monitor's routine.

What Is a Block Move?

A block move is a byte-by-byte movement of data from one range of memory to another. The area from where the data originates is called the source and the target area is called the destination. The length of the move is the difference between the source end and the source beginning plus one. The distance of the move is the difference between the source beginning and the destination beginning.

Let's use the monitor's routine to illustrate some examples of block moves. Type in the following sequence:

```

]CALL - 151
  (enter the monitor)
*3000:01 02 03 04 05 06 07 08
  (initialize memory)
*3000 < 3002.3003M
  (move 3002 - 3003 to 3000 - 3001)
  
```

Now type:

```

*3000.3007
  (dump range of memory)
  
```

and receive the following dump:

```

3000- 03 04 03 04 05 06 07 08
  
```

Observe that the block move was successful. Now try this:

```

*3001 < 3000.3006M
  (move 3000 - 3006 to 3001 - 3007)
*3000.3007
  (dump range of memory)
  
```

and receive the following dump:

```

3000- 03 03 03 03 03 03 03 03
  
```

The computer first moved 3000 to 3001, then 3001 to 3002, and so on, so that the full destination range is filled with the same value.

This situation is called an overlap. When the destination is higher than the

source combined with an overlap, it is necessary to move the data starting at the source end working toward the source beginning, which is called a right-move, as opposed to a left-move. By doing a right-move in the above example and dumping the range of memory, the following results would be obtained:

```

3000- 03 03 04 03 04 05 06 07
  
```

These results are correct.

A similar problem exists where the destination start address is lower than the source start address and the two ranges overlap. In this case the right-move (source-end first) will cause the same sort of problems and it is necessary to use the standard left-move (source start first) to avoid these problems. When the ranges do not overlap, it makes no difference which type of move is used, either the right-move or the left-move.

```

1 ;*****
2 ;*
3 ;*          BLOCK-MOVE          *
4 ;*          TIM OSBORN          *
5 ;*
6 ;*  A P P L E  S L I C E S  *
7 ;*
8 ;*****
9 ;
10 ;PAGE ZERO EQUATES
11 ;
12 ;A1 THRU A4 ARE PASSED FROM THE MONITOR
13 ;A5 IS COMPUTED INTERNALLY
14 ;
003C 15 ALL      EPZ $3C          ;A1=THE START OF SOURCE
003D 16 A1H     EPZ $3D
003E 17 A2L     EPZ $3E          ;A2=THE END OF SOURCE
003F 18 A2H     EPZ $3F
0042 19 A4L     EPZ $42          ;A4=THE START OF DESTINATION
0043 20 A4H     EPZ $43
0044 21 A5L     EPZ $44          ;A5=THE END OF DESTINATION
0045 22 A5H     EPZ $45
0800 23 ;
0800 24 ;OTHER EQUATES
0800 25 ;
0800 26 ;CTRL-Y VECTOR LOCATION
03F8 27 USRADR  EQU $3F8
0800 28 ;
0300 29          ORG $300
0300 30          OBJ $300
0300 31 ;
0300 32 ;START WILL ESTABLISH THE CONTROL-Y
0300 33 ;VECTOR. WHEN THE MONITOR ENCOUNTERS
0300 34 ;A CONTROL-Y IT WILL JUMP TO ENTRY
0300 35 ;
0300 A9 4C     36 START   LDA #$4C          ;JUMP INSTRUCTION
0302 8D F8 03 37         STA USRADR
0305 A9 10     38         LDA #ENTRY        ;LOW BYTE OF ENTRY ADDRESS
0307 8D F9 03 39         STA USRADR+1
030A A9 03     40         LDA /ENTRY        ;HIGH BYTE OF ENTRY ADDRESS
030C 8D FA 03 41         STA USRADR+2
030F 60       42         RTS          ;INITIALIZATION COMPLETE
0310 43 ;
0310 44 ;DISTL+DISTH RECYCLE START'S STORAGE
0310 45 ;SINCE START IS ONLY NEEDED AT BRUN
0310 46 ;
0300 47 DISTL    EQU START        ;INTERNAL STORAGE FOR
0301 48 DISTH    EQU START+1     ;THE DISTANCE OF THE MOVE
0310 49 ;
0310 50 ;ENTRY IS THE MAIN ENTRY POINT
0310 51 ;WHICH IS REACHED WHEN THE CTRL-Y
0310 52 ;IS ENCOUNTERED
0310 53 ;
0310 38       54 ENTRY    SBC          ;COMPUTE DISTANCE
0311 A5 42     55         LDA A4L          ;BY SUBTRACTING
0313 E5 3C     56         SBC A1L          ;THE SOURCE START (A1) FROM
0315 8D 00 03 57         STA DISTL      ; THE DESTINATION START (A4)
0318 A5 43     58         LDA A4H
031A E5 3D     59         SBC A1H
031C 8D 01 03 60         STA DISTH
031F 18       61         CLC
  
```

(Continued)

The Block-Move Routine

BLOCK-MOVE (listing 1) incorporates the ideas expressed above by performing all block moves where the destination address is higher than the source address with a right-move and all moves where the destination address is lower than the source address with a left-move.

To install BLOCK-MOVE you must BRUN the object code. The routine START will enable the CTRL-Y vector by initializing a JMP \$310 (the address of BLOCK-MOVE's ENTRY routine) into \$3F8 through \$3FA. When the monitor encounters a CTRL-Y (control key pressed simultaneously with the Y key) it will effectively JSR to \$3F8. After START initializes the CTRL-Y vector the monitor will effectively JSR to ENTRY upon encountering a CTRL-Y.

The syntax to use BLOCK-MOVE is exactly the same as that to use the monitor M command:

(dest) < (start).(end)

The [end] statement is then followed by a CTRL-Y instead of the usual M. When execution reaches ENTRY the monitor subroutines have already converted:

1. (dest) to a sixteen-bit integer stored at \$42 through \$43 (A4L through A4H or A4).
2. (start) to a sixteen-bit integer stored at \$3C through \$3D (A1L through A2H or A1).
3. [end] to a sixteen-bit integer stored at \$3E through \$3F (A2I through A2H or A2).

All of the above values are in modulo-256 form in low-byte, high-byte order. A user-written program can make use of BLOCK-MOVE by setting up the above values and JSR'ing to ENTRY.

BLOCK-MOVE must first compute the distance (DISTL through DISTH, \$300 through \$301) by subtracting A1 from A4 and storing the results at DIST (see lines 54 through 60). After this, DIST is added to A2 to obtain the destination end address — A5 (lines 61 through 67). Next destination start is compared to the source start in lines 68 through 76. If the source start is greater than the destination start, the MOVELT routine is used to perform the block move. If the destination start is greater than the source start then MOVERT routine is used. If the destination start is equal to the source start then no move is performed and an RTS is done at line 74.

MOVELT takes bytes starting at A2

```

0320 AD 00 03 62 LDA DISTL ;ADD DISTANCE
0323 65 3E 63 ADC A2L ;TO SOURCE END
0325 85 44 64 STA A5L ;TO OBTAIN DESTINATION END
0327 AD 01 03 65 LDA DISTH
032A 65 3F 66 ADC A2H
032C 85 45 67 STA A5H
032E A5 42 68 LDA A4L ;SEE IF DESTINATION IS
0330 C5 3C 69 CMP ALL ;GREATER OR LESS THAN SOURCE
0332 D0 07 70 BNE ENTRY1
0334 A5 43 71 LDA A4H ;ALSO CHECK TO MAKE SURE
0336 E5 3D 72 SBC A1H ;THAT A1 DOES'NT = A4
0338 D0 05 73 BNE ENTRY2
033A 60 74 RTS ;A1=A4 SO RETURN
033B A5 43 75 ENTRY1 LDA A4H
033D E5 3D 76 SBC A1H ;SOURCE
033F B0 03 77 ENTRY2 BCS MOVELT ;IT'S GREATER -MOVE RIGHT
0341 4C 67 03 78 JMP MOVELT ;IT'S LESS -MOVE LEFT
0344 79 ;
0344 80 ;MOVELT MOVES THE DATA STARTING AT THE
0344 81 ;SOURCE END WORKING TOWARDS THE
0344 82 ;SOURCE BEGINNING
0344 83 ;
0344 A0 00 84 MOVELT LDY #S00
0346 B1 3E 85 MOVELT1 LDA (A2L),Y ;GO FROM OLD END
0348 91 44 86 STA (A5L),Y ;TO NEW END
034A C6 44 87 DEC A5L ;DECREMENT DESTINATION POINTER

034C A9 FF 88 LDA #SFF
034E C5 44 89 CMP A5L ;IF A5L=SFF
0350 D0 02 90 BNE MOVELT2
0352 C6 45 91 DEC A5H ;THEN DECREMENT A5H
0354 C6 3E 92 MOVELT2 DEC A2L ;DECREMENT SOURCE POINTER
0356 C5 3E 93 CMP A2L ;IF A2L=SFF
0358 D0 02 94 BNE MOVELT3
035A C6 3F 95 DEC A2H ;THEN DECREMENT A2H
035C A5 44 96 MOVELT3 LDA A5L ;SEE IF WE HAVE MOVED
035E C5 42 97 CMP A4L ;ALL BYTES (A5=A4)
0360 A5 45 98 LDA A5H
0362 E5 43 99 SBC A4H
0364 B0 E0 100 BCS MOVELT1 ;NO MUST CONTINUE
0366 60 101 RTS ;ALL DONE
0367 102 ;
0367 103 ;MOVELT MOVES THE DATA STARTING AT
0367 104 ;THE BEGINNING OF THE SOURCE WORKING
0367 105 ;TOWARDS THE END OF THE SOURCE
0367 106 ;
0367 A0 00 107 MOVELT LDY #S00 ;INITIALIZE Y-REG
0369 B1 3C 108 MOVELT1 LDA (A1L),Y ;MOVE FROM OLD SOURCE
036B 91 42 109 STA (A4L),Y ;TO NEW DESTINATION
036D E6 3C 110 INC A1L ;INCREMENT SOURCE POINTER
036F D0 02 111 BNE MOVELT2 ;IF EQUAL TO ZERO
0371 E6 3D 112 INC A1H ;THEN INCREMENT HIGH BYTE
0373 E6 42 113 MOVELT2 INC A4L ;INCREMENT DEST POINTER
0375 D0 02 114 BNE MOVELT3 ;IF EQUAL TO ZERO
0377 E6 43 115 INC A4H ;THEN INCREMENT HIGH BYTE
0379 A5 44 116 MOVELT3 LDA A5L ;CHECK TO SEE IF
037B C5 42 117 CMP A4L ;WE ARE DONE WITH MOVE (A4=A5)

037D A5 45 118 LDA A5H
037F E5 43 119 SBC A4H
0381 B0 E6 120 BCS MOVELT1 ;NOT DONE, LOOP
0383 60 121 RTS ;ELSE RETURN TO CALLER
0384 122 END

```

(source end) and moves them to A5 (destination end). It decrements both values moving another byte after each decrement until A5 = A4, which means the destination pointer is equal to the destination beginning. (See lines 84 through 101.)

MOVELT takes bytes starting at A1 (source start) and moves them to A4 (destination start). It increments both values moving another byte after each increment until A4 = A5, which means that the destination pointer is equal to the destination end. (See lines 107 through 122.)

Both routines return to the monitor (or user-written program) when they

have completed their task. Experiment with BLOCK-MOVE and the monitor move command to get a feel for the differences between the two routines.

The advantage of using the monitor subroutine is that it allows you to initialize memory to desired patterns of byte values. It can be very handy, for instance, to initialize ranges of memory to binary zeros, but it is not limited to that. All sorts of patterns can be created depending upon the nature of the overlap. For those times when you are moving data forward with overlapping ranges of memory, use BLOCK-MOVE.

MICRO™

Reviews in Brief

Product Name: The Programmable Cube
Equip. req'd: Apple II with 48K or 64K and DOS 3.3
Price: \$34.95 includes diskette and extensive documentation
Manufacturer: Metacomet Software
P.O. Box 31337
Hartford, CT 06103

Description: This program will solve a Rubik's cube. "Cube" will scramble a cube and solve it for you. It also has an option to make designs and patterns. It is easy to use and relies on standard cube notation for entering moves.

Pluses: *The Programmable Cube* comes with an extensive user's guide to teach how to write programs to make designs or even solve cubes based on your own cube-solving strategy. It has a "mirror" behind the graphics cube to show the obverse sides of the cube. The program also includes simulated rotation of the cube as moves are made. You can enter a cube of your choice or choose the order of the colors on the cube.

Minuses: The language, while not difficult to learn, is similar to many of the graphics-control programs and takes a fair amount of time to become familiar with it.

Skill level required: Ability to follow directions is needed to run the solving portion. Previous programming experience in any language would be a help to program in cube language.

Reviewer: Phil Daley

Product Name: Ghost Gobbler
Equip. req'd: TRS-80 Color Computer with 16K
Price: \$21.95/cassette; \$24.95/disk
Manufacturer: Spectral Associates
141 Harvard Ave.
Tacoma, WA 98466

Description: *Ghost Gobbler* is Spectral Associates' version of the popular arcade game, PAC-MAN. Using a joystick, you control a gobbler that travels around a maze eating dots. You must be wary of the four ghosts that also frequent the maze. If they catch you, you will be eaten. Your only protection is to eat an "energizer" dot, whereupon you can score points by gobbling the ghosts. There are 17+ screens, and extra points can be gained by gobbling bonus shapes. Extra men can be gained by scoring high.

Pluses: The game is in 6809 machine language, and comes on cassette. The program will load onto disk and execute properly from disk once loaded. The game is fast action, and operates smoothly in all skill levels. A teleportation spot allows the player to quickly escape to another section of the board. Sixteen skill levels are available, so novices and experts can compete on a more even scale.

Minuses: The game supports only one player at a time, though it does keep records of the ten highest scorers. It operates as a linear device rather than a switch type. Many

users complain of the joystick action at first, but practice does improve its action.

Documentation: A single sheet instruction.

Skill level required: Anyone who can handle a joystick can play the game, but expert skills are required to get past the first two or three screens.

Reviewer: John Steiner

Product Name: Speed Reader
Equip. req'd: Apple II with Applesoft in ROM and DOS 3.3
Price: \$
Manufacturer: Special Delivery Software
10260 Bandlely Drive
Cupertino, CA 95014

Description: *Speed Reader* is a five-part reading program designed to improve comprehension and increase reading speed through the development of concentration, attention span, and more effective eye movement. Two copies of the *Speed Reader* Master Program diskettes, one copy of the *Speed Reader* Data diskette, and an easy-to-read manual are included in the software package. The main menu has five lessons: warm-up exercise (letters), warm-up exercise (words), eye movement exercise, column reading lesson, and reading passage lesson.

Pluses: The manual contains charts for each lesson on which progress can be recorded; user's scores are provided after each activity is completed. Several reading selections are offered in Lessons 3, 4, and 5, most of which are informative and interesting. You can increase reading speed, change column justification, and decrease window size in Lessons 3, 4, and 5.

Minuses: Vocabulary level and topics of several selections are beyond that of an average fifth-grade student. It is not clear to the user whether the RETURN key should be used to continue the program; no editing is permitted and selections cannot be added to the disk. Only one user can use *Speed Reader*; booting the diskette will not provide several users with the program.

Skill Level Required: Grades five through adult; private instruction. Spelling proficiency is a must as well as typing skills.

Reviewer: Cathy LaSalle

Product Name: GR2716 ROM/EPROM Emulator
Equip. req'd: Not applicable
Price: \$78.00
Manufacturer: Greenwich Instruments Limited
U.S. Distributor: LMS Electronics
3401 Monroe Road
Charlotte, NC 28205

Description: The *GR2716 EPROM Emulator* is a pin-for-pin replacement of the 2716 EPROM for use during system

Reviews in Brief *(continued)*

development. The device consists of RAM memory and a lithium power cell housed in a 24-pin package about .6 inches high. When used in the read mode, the device is plugged into a normal system EPROM socket, and functions exactly like an EPROM. Connectors with leads are supplied also. The package is provided with three additional wirewrap connections on the end between pins 1 and 24. Two of these pins are connected to the system reset to prevent inadvertent writing to the memory during system restart. When the third pin, labeled WE, is connected to a normal system static-write enable signal, it causes the circuit to function as a static RAM chip. The battery is guaranteed to retain memory for three years, with ten years quoted as typical. Other versions are available to replace other EPROMS.

Pluses: This processor performs exactly as specified. The documentation is terse, but adequate. New literature has come out since this review. Sample WE circuits are given for several CPUs.

Minuses: The legs appear fragile and could be broken easily. The problem can be circumvented by installing the GR2716 into a 24-pin soldertail socket and then plugging the entire assembly into the system. One other minor problem is the placement of the WE and Reset pins on the end of the device. There have been fit problems on crowded boards, but the chip-in-a-socket approach also solved this problem by raising the chip above board level.

Skill level required: Reasonably serious hardware and machine-language system software developer.

Reviewer: Wayne D. Smith

Product Name: Telewriter (disk version)
Equip. req'd: TRS-80C, 16K, RS disk system, printer
Price: \$49.95 cassette, \$59.95 disk
Manufacturer: Cognitec
704 Nob Ave.
Del Mar, CA 92014
(714) 755-1258

Description: *Telewriter* is a word processor for the TRS-80C. The editor features a cursor-oriented, 51- x 24-character display with real lower-case characters. The graphics screen is used for text display, and provides a much greater area of visible text than most color computer word processors.

Pluses: *Telewriter* is one of the better editors I have seen. Many features, including embedded printer commands, not found on more expensive processors, are available in *Telewriter*.

Minuses: Requires a disk I/O program on disks. The binary file format adds extra steps when using *Telewriter* with an ASCII file. Neither horizontal scrolling nor right justification is supported.

Documentation: Seventy pages of well-written reference material are included.

Skill level required: No previous experience with word processors is required.

Reviewer: John Steiner

MICRO

The watch is quiet. Scanners show nothing of rebel activity as you comb

QUADRANT 6112.

Suddenly, a stargate gapes open. A lone rebel ship surges into space. More alien comrades follow in attack. You must hold the Quadrant From the invaders. And you must do it alone!

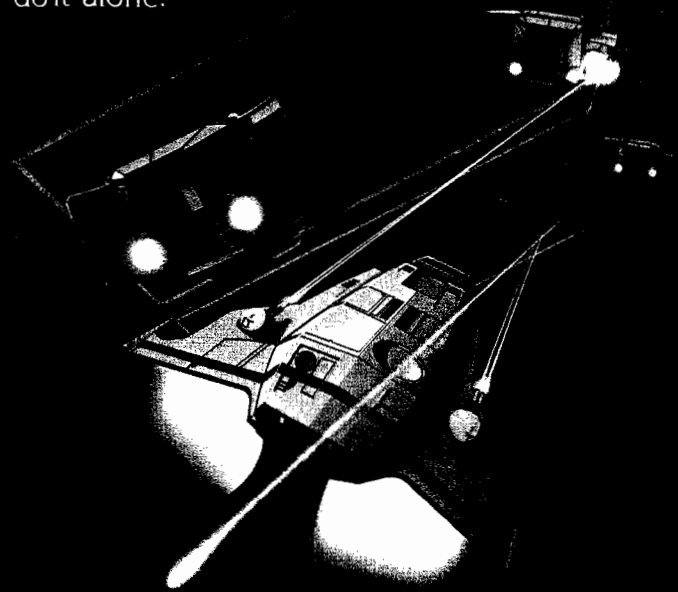

You're combing the quadrant, defending your turf, and suddenly, as if from nowhere, an alien ship appears. You spin and shoot, lasers blazing and blast him into oblivion, with more attackers soon to follow. The battle continues and you gain the upper hand. Just when you think you've got things under control, the alien commander appears. He's extremely fast and a very good shot, but you have a secret weapon, HEAT SEEKERS! The flick of a finger destroys every alien in your quadrant. With a few seconds rest you prepare yourself for the next wave of alien attack ships. GET READY, HERE THEY COME... **FIRE!**

Get Quadrant 6112 from your favorite dealer or directly from Sensible Software for only . . . **34.95**
(Game Paddle Required)



Sensible Software

6619 Perham Drive,
West Bloomfield, MI 48033
Phone (313) 399-8877

TM Designates U.S. Trademarks of Sensible Software Inc.
Copyright 1982 - Sensible Software Inc.

KIDS & THE VIC

KIDS & THE APPLE

HOW TO WRITE A TRS-80

HOW TO WRITE AN IBM-PC

HOW TO WRITE AN APPLE

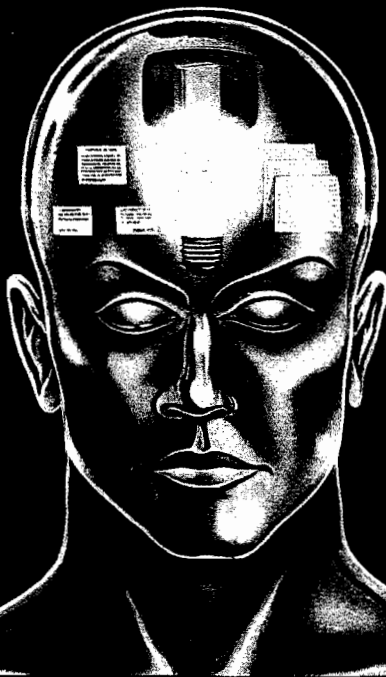

KIDS & THE ATARI

HOW TO WRITE A TRS-80

HOW TO WRITE AN APPLE

HOW TO WRITE AN IBM-PC

3 exceptional books join the DATAMOST library.

Here is a series of easy to read, easy to use, easy to understand books, which teach you how to write usable, useful programs on your computer. And you don't have to worry about irrelevant material which has no interest for you, because there are three specific volumes. One for the Apple, one for the IBM-PC, and one for the TRS-80.*

In each of these books author Ed Faulk leads you through your favorite computer and takes the mystery out of writing programs for it. As you proceed, interesting chapter by interesting chapter, you'll

wonder why you were ever intimidated by the thought of programming!

If you want to get the very most out of your Apple, IBM-PC or TRS-80 then you really want HOW TO WRITE A PROGRAM. Before you're past Chapter 2 you'll be programming. By the end of the book you'll be willing to tackle business programs, personal use programs and even games and adventures! **\$14.95**

Get your copy now. Available at computer and book stores, or:

DATAMOST (213) 709-1202
9748 Cozycroft Ave., Chatsworth, CA 91311

Reston Publishing Corp
A Prentice-Hall Company
Reston, Virginia
Toll free (800) 336-0338

*Apple is a trademark of Apple Computer, Inc. /IBM-PC is a trademark of IBM Corp. /TRS-80 is a trademark of Tandy Corp.
VISA MASTERCHARGE accepted. \$2.00 shipping/handling charge. (California residents add 6 1/2% sales tax.)

MONSTER MASH



It is late at night in a monster infested graveyard and you have been given the job of keeping the monsters in. All you have between you and complete chaos is a new MonsterMasher System and quick reflexes.

Monster Mash is an original and unique arcade action game written in assembly language for the Apple II and Apple /// (in emulation mode).

\$29.95



The Software Farm
3901 So. Elkhart
Aurora, CO. 80014
PH: (303) 690-7559

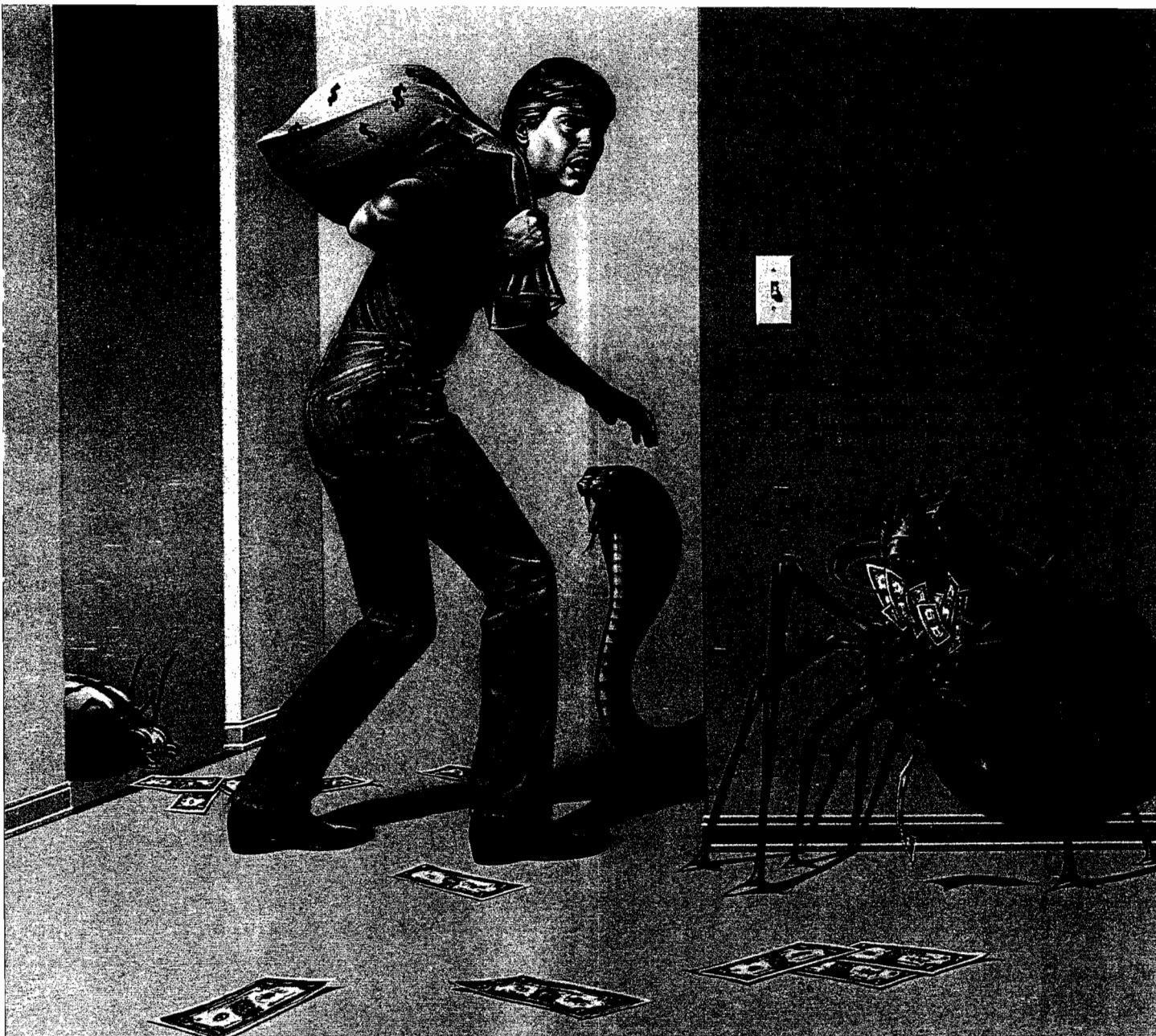

**Beware
the**



MUNCHERS

For the most maze
you've ever had at
thousands of ranc
mazes, get MONE
MUNCHERS today
millionaire tonight

by Bob Bishop

\$29.95 for the Apple II*
At computer stores, or:

DATA MOST INC

9748 Cozycroft Ave., Chatsworth, CA 91311. (213) 709-1202

VISA/MASTERCARD accepted. \$2.00 shipping/handling charge.
(California residents add 6 1/4% sales tax.)

*Apple II is a trademark of Apple Computer, Inc.

Getting Around the Apple Hi-Res Graphics Page

by Eagle I. Berns

This article describes a method to split an Applesoft BASIC program in order to make available the core both above and below the hi-res pages. This allows the program to utilize the graphics area without having to sacrifice portions of memory.

GETTING

requires:

Apple II with 32K
RENUMBER

If your Apple II has 48K of memory, and you write a program that starts at \$0800 (hex) and goes to, say, \$4100, you may notice that though there's still a lot of core available for your program, you have lost the ability to use either of the hi-res graphics pages (the first runs from 2000 to 3FFF and the second from \$4000 to \$5FFF). When this problem came up for me, I wondered if there might be some way to have my program bridge the gap over either or both the graphics areas and continue on the other side.

In reading current literature I found various references to ways in which this could be done. However, they all required multiple steps and patching source statements. What I wanted was an automatic process. There are several EXEC files used in the process I eventually developed, but the user of the program need only issue the one command "RUN SPLIT", and the rest of the process is automatic.

The EXEC files and utility program needed to do the job are listed at the end of this article. First, however, I will give a general description of how the task is accomplished, and then a detailed description of the program itself.

Basically, the statements of the Applesoft program to be split are scanned via their internal pointer links from statement to statement, until the last

statement before location \$2000 is reached. At this point a number of dummy statements are inserted. (This version uses the &Renum utility from the Apple II tool kit to renumber the program in a way that allows the insertion of a number of dummy statements. A simple modification is necessary if some other renumber utility is used.) The utility then proceeds to find the link that exists between the location before \$2000, and the location

directly after \$4000. It then finds the places to POKE, relinking the program across the dummy statements (where the graphics area is located). Since a LOAD will reset all links, the two POKES must be a part of the original program. Also, since the POKES must be there when the split is complete, they must be inserted before we begin the split, so as not to destroy the relative positioning of statements in the program.

Listing 1: SPLIT

```
100 TEXT : HOME
110 PRINT "ENTER NAME OF PROGRAM TO SPLIT": PRINT : PRINT : HTAB (7): INPUT
    A$
120 PRINT
130 PRINT "ENTER LOMEM ADDRESS FOR LOADING PROGRAM": PRINT : PRINT : HTAB
    (7): INPUT L
140 PRINT : PRINT "ENTER 1 IF SPLITTING OVER HGR1,"
150 PRINT "      2 IF SPLITTING OVER HGR2,"
160 PRINT "      0 IF SPLITTING OVER BOTH."
170 PRINT : PRINT "WHICH " : INPUT S
180 A = INT (L / 256)
190 B = L - A * 256
200 REM
210 POKE 210,B: REM SAVE LOMEM
220 POKE 211,A
230 REM
240 REM SET SPLIT BOUNDS.
250 REM 212 HOLDS START OF PAGE
251 REM 213 HOLDS LENGTH
260 REM 771 HOLDS LENGTH
270 REM
280 IF S = 1 THEN 320
290 IF S = 2 THEN 330
300 IF S = 0 THEN 340
310 GOTO 140
320 POKE 212,32: POKE 213,32: GOTO 360
330 POKE 212,64: POKE 213,32: GOTO 360
340 POKE 212,32: POKE 213,64
350 REM
360 D$ = CHR$ (4)
370 PRINT D$:"OPEN SPL.SETUP"
380 PRINT D$:"DELETE SPL.SETUP"
390 PRINT D$:"OPEN SPL.SETUP"
400 PRINT D$:"WRITE SPL.SETUP"
410 PRINT "FP"
420 PRINT "RUN LOADAPA"
422 PRINT "POKE 103,";B + 1
424 PRINT "POKE 104,";A
426 PRINT "POKE ";B;"0"
430 PRINT "LOAD ";A$
440 PRINT "&R 2,1"
450 PRINT "1 POKE 0000,000:POKE 0000,00"
460 PRINT "SAVE SPLITPROG"
470 PRINT "EXEC SPL.FINDER"
480 PRINT D$:"CLOSE SPL.SETUP"
490 PRINT D$:"EXEC SPL.SETUP"
```

When the RUN SPLIT command is issued, you see the following:

ENTER THE NAME OF THE PROGRAM TO SPLIT
<type in the name>

ENTER LOMEM ADDRESS FOR LOADING PROGRAM
<Normally this is 2048 (or \$0800), but you may change this, if you like>

ENTER 1 IF SPLITTING OVER HGR1
2 IF SPLITTING OVER HGR2
0 IF SPLITTING OVER BOTH

WHICH: <your choice depending on your needs>

Then wait as your screen goes through some contortions, writing messages, etc. Finally it will write out: END OF JOB. A program called SPLITPROG will have been created which, when run, will not be interfered with if hi-res graphics are used. Be sure to hold on to the original program for making

modifications since SPLITPROG does not accept modifications gracefully.

Now I will present the programs and support utilities, with a description of their execution sequence.

SPLIT Description

Lines 180-350 are POKEd away for the rest of the utilities to use. Loc's 210 and 211 are for program start-up location; 212 and 213 are the addresses for the boundaries of the split.

Lines 370-400 and 580-590 create and execute SPL.SETUP, which does the following:

FP <cleans things up a bit>
RUN LOADAPA <from Apple II Tool Kit>

POKE 103, <addr1> <set up LOMEM
POKE 104, <addr> for loading the
POKE <loc>,0 user program to be split>

LOAD <program> <loads the program>

&R 2,1 <renumbers to allow a dummy line 1 to be inserted that will be modified>

1 POKE 0000,000:POKE 0000,00

SAVE SPLITPROG <this will eventually become the split program>

EXEC SPL.FINDER <goes off to find where to split>

SPL.FINDER Description

The EXEC is copied to the end of the user program and then that part is executed.

Lines 63980-63984 scan the program to be split to find the statement just preceding the hi-res page beginning.

Lines 63984-63986: if the program isn't large enough to require splitting, we stop here.

Lines 63987-63988 POKE away the statement number detected for later use.

Line 63989 invokes the next phase, which does the actual splitting process.

SPL.EXEC MAKER Description

Lines 5-6 compute the number of dummy REM SPLIT statements to be inserted to cover the appropriate graphics area.

Line 7 retrieves the line number where the split starts.

Lines 8-80 create and execute TEMPEXEC, which performs the following functions upon invocation:

Lines 31-34 set up the appropriate LOMEM value and then load SPLITPROG.

Line 35 renumbers the program to allow insertion of the REM split statements.

Line 36 adds a GOTO statement around the REMs so they can't be executed.

Lines 37-60 add the dummy REM statements.

Line 65 EXECs the final phase of the splitting process, which creates the appropriate POKE for line 1 to relink the final program execution.

Listing 2: SPLIT FINDER

```
63980 I = 1 + PEEK (210) + PEEK (211) * 256
63981 J = PEEK (I + 1)
63982 IF J = PEEK (212) THEN 63987
63983 M = I:I = J * 256 + PEEK (I)
63984 IF I <> 0 THEN 63981
63985 PRINT "PROGRAM DOES NOT REACH HIGH-RES PAGE"
63986 END
63987 POKE 208, PEEK (M + 2): POKE 209, PEEK (M + 3)
63988 POKE 103, 1: POKE 104, 8: POKE 2048, 0
63989 PRINT CHR$(4); "RUN SPL.EXEC MAKER"
RUN 63980
```

Listing 3: SPLIT EXEC MAKER

```
5 Y = 36
6 IF PEEK (213) = 64 THEN Y = 72
7 Z = PEEK (209) * 256 + PEEK (208)
8 D$ = CHR$(4)
9 PRINT D$; "OPEN TEMPEXEC"
10 PRINT D$; "DELETE TEMPEXEC"
20 PRINT D$; "OPEN TEMPEXEC"
30 PRINT D$; "WRITE TEMPEXEC"
31 PRINT "POKE 103,PEEK(210)+1"
32 PRINT "POKE 104,PEEK(211)"
33 PRINT "POKE (PEEK(210)+256*PEEK(211)),0"
34 PRINT "LOAD SPLITPROG"
35 PRINT "&R ";Z + 3 + Y; ",1,";Z
36 PRINT Z;" GOTO ";Z + 3 + Y
37 PRINT Z + 1;" REM SPLIT"
40 FOR I = Z + 2 TO Z + 2 + Y
50 PRINT I;" REM SPLIT SPLIT SPLIT SPLIT SPLIT SPLIT SPLIT SPLIT SPLIT S
  SPLIT SPLIT SPLIT SPLIT SPLIT SPLIT SPLIT SPLIT SPLIT SPLIT SPL
  IT SPLIT SPLIT SPLIT SPLIT SPLIT SPLIT SPLIT SPLIT SPLIT SPLIT SPLIT
  SPLIT SPLIT SPLIT SPLIT SPLI"
60 NEXT I
65 PRINT "EXEC SPL.PATCHER"
70 PRINT D$; "CLOSE TEMPEXEC"
80 PRINT D$; "EXEC TEMPEXEC"
```

Listing 4: SPLIT PATCHER

```

63970 I = 1 + PEEK (210) + 256 * PEEK (211)
63971 J1 = PEEK (208):J2 = PEEK (209)
63972 IF ( PEEK (I + 2) = J1) AND ( PEEK (I + 3) = J2) THEN 63976
63973 I = PEEK (I) + PEEK (I + 1) * 256:M = I
63975 GOTO 63972
63976 K = M
63977 J = PEEK (M + 1)
63978 IF J = ( PEEK (212) + PEEK (213)) THEN 63981
63979 M = J * 256 + PEEK (M)
63980 GOTO 63977
63981 PRINT CHR$ (4);"OPEN TEMPEXEC"
63982 PRINT CHR$ (4);"DELETE TEMPEXEC"
63983 PRINT CHR$ (4);"OPEN TEMPEXEC"
63984 PRINT CHR$ (4);"WRITE TEMPEXEC"
63985 PRINT "1 POKE ";K;";";
63986 L = PEEK (M):J = 2: IF L > 9 THEN J = 1: IF L > 99 THEN 63988
63987 PRINT LEFT$ ("000",J);
63988 PRINT L;"; POKE ";K + 1;";"; PEEK (M + 1)
63989 PRINT "PRINT CHR$ (4);"; CHR$ (34);"DELETE SPL.SETUP"; CHR$ (34)
63990 PRINT "DEL 63970,63995"
63991 PRINT "SAVE SPLITPROG"
63992 PRINT "PRINT "; CHR$ (34);"END OF JOB"; CHR$ (34)
63993 PRINT "PRINT CHR$ (4);"; CHR$ (34);"DELETE TEMPEXEC"; CHR$ (34)
63994 PRINT CHR$ (4);"CLOSE TEMPEXEC"
63995 PRINT CHR$ (4);"EXEC TEMPEXEC"
RUN 63970
    
```

Lines 63981-63995 create and EXEC TEMPEXEC, which does the following:

Lines 63985-63988 replace the initial dummy POKE with the appropriate POKE for relinking the program.

Lines 63989-63993 clean up some of the garbage left by the process, save the final SPLITPROG, and print the "END OF JOB" message.

As you can see, a lot goes on, and a number of EXEC files are executed. This is mainly for the purpose of making the entire process automatic. I welcome any changes or modifications that would streamline the process.

Mr. Berns has been involved in computing since 1959, working on large-scale computer systems as a systems analyst/programmer. He has written both the BASIC compiler and interpreter and the LISP system for Stanford University where he has been employed for the past 14 years. He may be contacted at 735 La Para Ave., Palo Alto, CA 94306.



SPL.PATCHER Description

The EXEC is copied to the end of the user program and then that part is executed.

Lines 63970-63980 compute the actual machine addresses before and after the split, which must be modified to relink the program.

**Model EP-2A-79
EPROM Programmer**

- North Star
- Apple
- S-100
- SS-50
- STD-Bus
- Atari
- Pet
- Kim-1

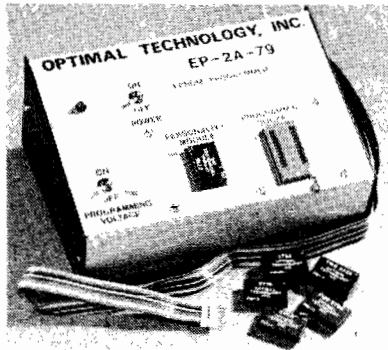

- TRS-80
- H-8
- H-89
- Ohio
- Scientific
- SWTP
- Aim-65
- Sym-1

Three years in the field with unsurpassed performance. Software is available for the EP-2A-79 for most all of the microcomputers including the popular CP/M, FLEX, HDOS operating systems. Write or call for specific hardware/software interfacing. Driver packages available for F-8, 6800, 6809, 8080,8085, Z-80, 1802, 6502 and 2650 based systems.

EP-2A-79 115V 50/60 HZ\$169.00

Personality Modules

PM-0 TMS 2708 \$17.00	PM-5 2716,2758 \$17.00
PM-1 2704, 2708 17.00	PM-5E 2816 35.00
PM-2 2732 33.00	PM-8 MCM68764 35.00
PM-2A 2732A 33.00	PM-9 2764 35.00
PM-3 TMS 2716 17.00	SA-64-2 TMS 2564 39.00
PM-4 TMS 2532 33.00	SA-64-3 2764 39.00

Optimal Technology, Inc.

Phone (804) 973-5482
Blue Wood 127 Earlysville, VA 22936

QCB-9 SINGLE BOARD COMPUTER

- 6809 BASED
- RUNS TSC FLEX DOS
- ★ QCB-9/1 S-100 BUS
- ★ QCB-9/2 SS-50 BUS

\$149.00*
*PARTIAL KIT

FEATURES

- 5 1/4" Floppy Controller
- Serial RS-232 Port
- Centronics Type Printer Port
- Keyboard / Parallel Port
- 24K Bytes of Memory
- QBUG Resident Monitor
- 6802 Adaptor

FULLY ASSEMBLED & TESTED \$389.00

- 48-hour Burn-in
- 90 Day Warranty

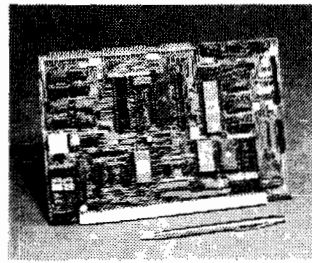

NAKED-09 SS-50 6809 CPU CARD \$49.95*

- ★ 1K OF RAM AT E400 Assembled & Tested \$149.00
- ★ 6K OF EPROM AT E800-FFFF 2 MHz Version \$189.00
- ★ HIGH QUALITY DOUBLE SIDED PCB ★ SOLDER MASKED ★ SILK SCREENED

TSC, FLEX DOS, ASSEMBLER, EDITOR \$150.00

QBUG RESIDENT MONITOR \$50.00

- ★ Disc Boot
- ★ Memory Exam & Exchange
- ★ Memory Dump
- ★ Memory Test
- ★ Zero Memory
- ★ Fill Memory
- ★ Break Points
- ★ Jump to User Program
- ★ Register Display & Change

QBUG IS A TRADEMARK OF LOGICAL DEVICES INC.. * Copyright 1981

PHONE ORDERS: (305) 776-5870

LOGICAL DEVICES INC.

COMPUTER PRODUCTS DIVISION
781 W. OAKLAND PARK BLVD. • FT. LAUDERDALE, FL 33311
TWX: 510-955-9496 • WE ACCEPT VISA, MC, CHECKS, C.O.D., MONEY ORDER

Extra Colors for the Atari

by Richard I. and Donna M. Marmor

Two techniques are presented to achieve extra colors on the Atari screen. One uses alternating adjacent dots of different colors, while the other uses alternating displays of different colors.

Extra Colors

requires:

Atari 400/800 (8K)

Atari graphics modes are limited in the number of colors that can be displayed at any one time. In Mode 7, for example, only four colors can be used. There are many techniques available that will expand your choices. In this article we describe two of them and provide sample program illustrations.

Color Dot Mixing

With this technique you place pixels of different colors next to one another in an alternating pattern. For instance, a red pixel followed by a blue pixel followed by a red pixel, and so on. In a relatively large bounded area, such as a square, the overall perceived shade is distinct from the individual colors comprising the pattern. Using this approach, the number of distinct colors in Mode 7 expands to 10: primary colors 1, 2, 3, and 4; and the "mixed" colors 1-2, 1-3, 1-4, 2-3, 2-4, and 3-4. Of course, you must make a judicious choice of the four primary colors so that the mixed colors will look good and appear distinct.

Program 1 will help in your exploration of Color Dot Mixing. It places two sets of two squares on a Mode 7 screen, one against a white background and one against a black background. The program then asks you to type in a pair of color-luminance combinations. It colors a square in each set with each color you chose, and then shows you the result of the mix in a square directly below. Why are there two sets of squares? Since colors look different

Listing 1

```
1 REM **PROGRAM 1**
2 REM
3 REM ILLUSTRATES COLOR DOT MIXING
4 REM YOU INPUT THE COLORS YOU WANT
5 REM THE PROGRAM THEN DISPLAYS THEM
6 REM AND MIXES THEM FOR YOU-
7 REM AGAINST A WHITE AND BLACK BACKGROUND
8 REM
9 GRAPHICS 7
10 SETCOLOR 0,0,14:COLOR 1
11 FOR I=80 TO 159 STEP 1
12 PLOT I,0:DRAWTO I,79:NEXT I
13 PLOT 10,10
14 DRAWTO 20,10:DRAWTO 20,20:DRAWTO 10,20:DRAWTO 10,10
15 PLOT 30,10
16 DRAWTO 40,10:DRAWTO 40,20:DRAWTO 30,20:DRAWTO 30,10
17 PLOT 20,30
18 DRAWTO 30,30:DRAWTO 30,40:DRAWTO 20,40:DRAWTO 20,30
19 COLOR 0
20 PLOT 90,10
21 DRAWTO 100,10:DRAWTO 100,20:DRAWTO 90,20:DRAWTO 90,10
22 PLOT 110,10
23 DRAWTO 120,10:DRAWTO 120,20:DRAWTO 110,20:DRAWTO 110,10
24 PLOT 100,30
25 DRAWTO 110,30:DRAWTO 110,40:DRAWTO 100,40:DRAWTO 100,30
26 COLOR 2
27 FOR I=11 TO 19 STEP 1
28 PLOT I,11:DRAWTO I,19
29 PLOT I+80,11:DRAWTO I+80,19
30 NEXT I
31 FOR I=21 TO 29 STEP 2
32 FOR J=31 TO 39 STEP 2
33 PLOT I,J:PLOT I+80,J
34 NEXT J:NEXT I
35 FOR I=22 TO 29 STEP 2
36 FOR J=32 TO 39 STEP 2
37 PLOT I,J:PLOT I+80,J
38 NEXT J:NEXT I
39 COLOR 3
40 FOR I=31 TO 39 STEP 1
41 PLOT I,11:DRAWTO I,19
42 PLOT I+80,11:DRAWTO I+80,19
43 NEXT I
44 FOR I=22 TO 29 STEP 2
45 FOR J=31 TO 39 STEP 2
46 PLOT I,J:PLOT I+80,J
47 NEXT J:NEXT I
48 PRINT "First color (0-15), lum(0-14 even)"
49 INPUT CF,LF
50 PRINT "Second color (0-15), lum(0-14 even)"
51 INPUT CS,LS
52 SETCOLOR 1,CF,LF
53 SETCOLOR 2,CS,LS
54 PRINT :PRINT :PRINT
55 PRINT "First: Color=";CF;" Lum=";LF
56 PRINT "Second: Color=";CS;" Lum=";LS
57 GOTO 360
```

against different background colors, we decided to experiment with different backgrounds.

You can easily modify this program to further enlarge the technique. Why not mix more than two colors? Or how about different cycles; one red pixel followed by two blue pixels, for example? Try background colors other than black and white. You'll really see the difference!

The possibilities from color dot mixing are great and they are suitable for many applications. The resulting colors, however, appear rather coarse to the eye. The next technique uses display list interrupts to create new colors that are much purer and far more pleasing to the eye.

Color Dot Alternation

To understand this technique, we must first review some Atari display theory. When you look at a display on your television or monitor, it appears almost as if the display is painted on the screen. Actually, the display is being regenerated by ANTIC, 60 times per second. But this is so fast that you don't see the resulting flicker.

An explanation of the display list and display list interrupts appears in many places, so we won't go into that in great detail: just enough to give a frame of reference. Every 60th of a second (or frame), ANTIC goes through its display list and associated display memory, retrieving the color register number for a given pixel from display memory and displaying the pixel at the correct point on the screen in the color specified in the appropriate color register. What would happen if, on alternate frames, different colors were displayed for the same pixel? During frame 1, for instance, the color of a pixel might be red. During frame 2, it might be blue. During frame 3, it would go back to red, and so on. The result, according to color wheel theory, is that the pixel should appear purple. And indeed it does. If you kept track which pixels of your display should be pure red, which should be pure blue, and which should be alternating red-blue, you would obtain three pure and distinct colors for the price of two! In a Mode 7 display, this makes 10 colors a possibility.

This technique may be implemented in several ways. Program 2 demonstrates one way. As in program 1, program 2 asks you to type in two color-luminance combinations. These colors are displayed in separate squares, and then below them a rectangle is displayed with the colors alternating on different display frames.

The alternation is produced by the

Listing 2

```
1 REM **PROGRAM 2**
2 REM
3 REM ILLUSTRATES COLOR DOT ALTERNATION
4 REM YOU INPUT THE COLORS YOU WANT
5 REM THE PROGRAM THEN DISPLAYS THEM
6 REM AND MIXES THEM FOR YOU
7 REM
10 GRAPHICS 7
20 SETCOLOR 4,0,14
30 PRINT "FIRST COLOR(0-15), LUM(0-14 EVEN)"
40 INPUT CF,LF
50 PRINT "SECOND COLOR(0-15), LUM(0-14 EVEN)"
60 INPUT CS,LS
70 SETCOLOR 0,CF,LF
80 SETCOLOR 1,CS,LS
90 COLOR 1
100 FOR I=21 TO 39
110 PLOT I,21:DRAWTO I,39:NEXT I
120 COLOR 2
130 FOR I=51 TO 69
140 PLOT I,21:DRAWTO I,39:NEXT I
170 SETCOLOR 2,0,0
180 COLOR 3
190 FOR I=26 TO 54
200 PLOT I,51:DRAWTO I,69:NEXT I
210 POKE 36770,240
215 RESTORE
220 FOR I=0 TO 39
230 READ A:POKE 1536+I,A:NEXT I
240 DATA 72,138,72,169,0,141,10,212
250 DATA 141,24,208,169,20,141,0,2
260 DATA 104,170,104,64,72,138,72
270 DATA 169,0,141,10,212,141,24,208
280 DATA 169,0,141,0,2,104,170,104,64
290 POKE 1540,CF*16+LF:POKE 1560,CS*16+LS
300 POKE 512,0:POKE 513,6
310 POKE 54286,192
320 END
```

display list interrupt routines shown in listing 3. In listing 2, the routines are POKEd into memory at lines 220-280. When the routines are executed in their appropriate frames, the color register used for the third square is flip-flopped between the two colors you chose. During the odd frames, the color register is set to the first color. During the even frames, the color register is set to the second color. Each interrupt routine causes the other one to execute during the next frame by modifying the display list interrupt vector. The input colors are set into the interrupt routines by line 290. The result on the screen is that the third square has a different color than the other two.

To fully utilize Color Dot Alternation, some additional programming is needed. You must keep track of which pixels are to be mixed and which are not. This can be accomplished by using multiple display list interrupts in con-

junction with tables giving the mode lines to be mixed.

The implementation given here uses two display list interrupts for alternate frames. Another method is to use a single display list interrupt that flip-flops a color register. You would change the contents of the color register during alternate frames. A final method, although costly in memory, is to have two separate display memories. One would contain the color register numbers used during the odd frames, and the other would contain the color register numbers used during the even frames. If a pixel is to be a pure color, its associated color register number would be the same for odd and even frames. If a pixel is to be mixed, its color register number would alternate in the two display memories between the two registers to be mixed. A display list interrupt would be used to change the display list itself to point to the two

Listing 3

DISPLAY LIST INTERRUPT ROUTINES FOR PROGRAM 2

```

PHA      ODD FRAME DLI ROUTINE
TXA
PHA
LDA #0   AT RUN TIME CONTAINS FIRST INPUT COLOR
STA WSYNC
STA COLPF2 PUTS FIRST COLOR IN COLOR REGISTER 2
LDA #20  SETS EVEN FRAME DLI ROUTINE
STA #512 TO EXECUTE DURING NEXT FRAME
PLA
TAX
PLA
RTI
    
```

```

PHA      EVEN FRAME DLI ROUTINE
TXA
PHA
LDA #0   AT RUN TIME CONTAINS SECOND INPUT COLOR
STA WSYNC
STA COLPF2 PUTS SECOND COLOR IN COLOR REGISTER 2
LDA #0   SETS ODD FRAME DLI ROUTINE
STA #512 TO EXECUTE DURING NEXT FRAME
PLA
TAX
PLA
RTI
    
```

display memory areas for different frames.

One warning about this technique. When you alternate between colors of different luminances, flickering will occur. The flickering will worsen as the luminances get farther apart and will be almost non-existent when the luminances are the same, especially with the higher color numbers. This flicker effect can be very useful for special effects in your programming.

The expansion possibilities for Color Dot Alternation seem endless. You can experiment with cycles of three or more. With a cycle of two, your color palette is 256. With higher cycle numbers, the choices are greater, of course. We have used the technique effectively with cycles of up to four.

Both Color Dot Mixing and Color Dot Alternation are simple techniques that expand the color possibilities of your Atari. By using these techniques, or variations, you can begin to realize the full graphics potential of your computer.

Contact the authors at 901 Green Forest Drive, Montgomery, AL 36109.

MICRO™

APPLE II PERIPHERAL DEVELOPERS:

Your complex function prototype requires the best wirewrap board available.

SPECTRUM SYSTEMS MAKES IT!

Fully Extended Wirewrap Protoboard.

Size: 2.8 by 10.7 inch 2 layer PC.
Capacity: up to 58-16 pin or 12-40 pin or any combination sockets inbetween.

Carefully designed +5 and GND planes provide for the minimum electrical noise, low impedance, hi capacitance, and maximum versatility in the layout of IC's, capacitors, discretes and I/O connectors.

Wire-wrap technique documentation included.

Terms:

- \$45.00 + (6% Cal. Res. tax) + \$2.00 S&H.
- All payments must be in U.S. funds drawn on a U.S. bank.
- Outside U.S. add 10%.
- Cashier check/money order allow 30 day ARO.
- Personal checks add 2 weeks.
- No credit cards or cash, Please!

Spectrum Systems
P.O. Box 2262
Santa Barbara, Ca. 93120

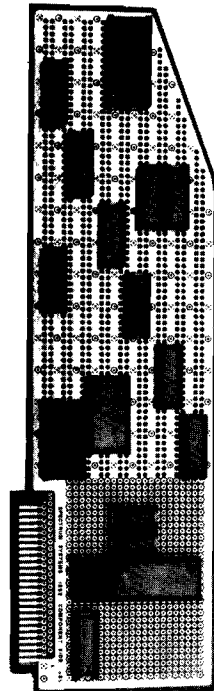

Apple II is a trademark of Apple Computers.



BASF

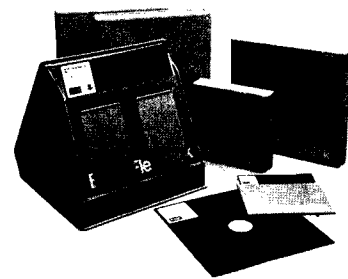

the LEADER
of the pack . . .

Write for free catalog with more than 400 fantastic values for all your word and data processing needs. Outside USA, enclose \$1.00 .

ABM PRODUCTS
8868 CLAIREMONT MESA BLVD.
SAN DIEGO, CALIFORNIA 92123

Toll Free 800-854-1555 Orders Only
For information or California Orders
(714) 268-3537

Introduction to 3-D Rotations on the Apple

by Chris Williams

The techniques of 3-D rotation are discussed. An Applesoft demonstration program is provided, which includes general-purpose routines for yaw, pitch, and roll.

ROTATE

requires:

Apple with Applesoft

I am fascinated by the computer-generated special effects recently proliferated through the film industry. The primary building block for these special effects is the 3-D rotation. I've discovered that these effects are remarkably easy to produce; this article and program pass on the techniques required.

The program is written entirely in Applesoft and isn't offensively slow, but don't expect fluid motion. The program documentation is thorough, but you should make two copies (one with REMs, one without). Executing the REMed program will try your patience.

I won't provide an in-depth discussion on the math; you don't need to understand it to do rotations. Just strip out my subroutines and use them where you need them.

The program draws a hi-res 3-D rectangular box and then rotates it. The rotation occurs in discrete steps of 15 degrees. It takes about 90 seconds to rotate through 360 degrees.

This box is a real-world object — it has height, width, and depth. The task in doing 3-D display is to project real-world objects onto a two-dimensional surface.

Figure 1 is the Apple hi-res screen for X and Y. Z is supposed to be an axis drawn out of the screen and perpendicular to it. Since that can't be done, represent Z as a line drawn at a 45-degree angle, upper left to lower right. This line allows you to put depth on the screen.

Figure 2 introduces the box and shows how the 3-D to 2-D projection works. Notice that the corners of the

object are numbered points. They correspond to the CR array in the program. This array is dimensioned (3,8). The object has eight corners and each corner has three elements representing X, Y, and Z coordinates. Lines 170 through 400 of the program simply define the box in 3-D space.

Now you need to project it onto the 2-D plane. X and Y coordinates correspond precisely so they pose no problem. The Z coordinate is another matter.

Since Z is defined to be at 45 degrees to both X and Y, then the Z coordinate

is related to X and Y as $X = \sin(45) * Z$, $Y = \sin(45) * Z$. Sine and cosine of 45 degrees are both .707. Specify a corner's position in 3-D space as CR(1,I), CR(2,I), and CR(3,I) where I selects the corner and 1,2,3 is XYZ. A corner's 2-D projection onto the X-Y screen is computed in lines 490 and 500 using $X = X + .707 * Z$, $Y = Y + .707 * Z$. Lines 510 and 520 are there merely for scaling and putting the box near the center of the screen.

The edges of the box are defined even more simply. They are in a table look-up contained within arrays I1 and I2. Notice that both these arrays are dimensioned as 12 as there are 12 edges on the box.

The number in each element of these arrays is a corner (see figure 2). That means an edge exists from point I1(I) to point I2(I). If you look at lines 550 through 590, you'll see HPLLOT draws an edge from X(I1(I)), Y(I1(I)) to X(I2(I)), Y(I2(I)).

That's all it takes to draw a 3-D box. You can convince yourself of this by turning off the rotation in the program (insert line 455 GOTO 480). This will display the box in X,Y.

Now take out the GOTO and try rotating. Here, the problem is again one

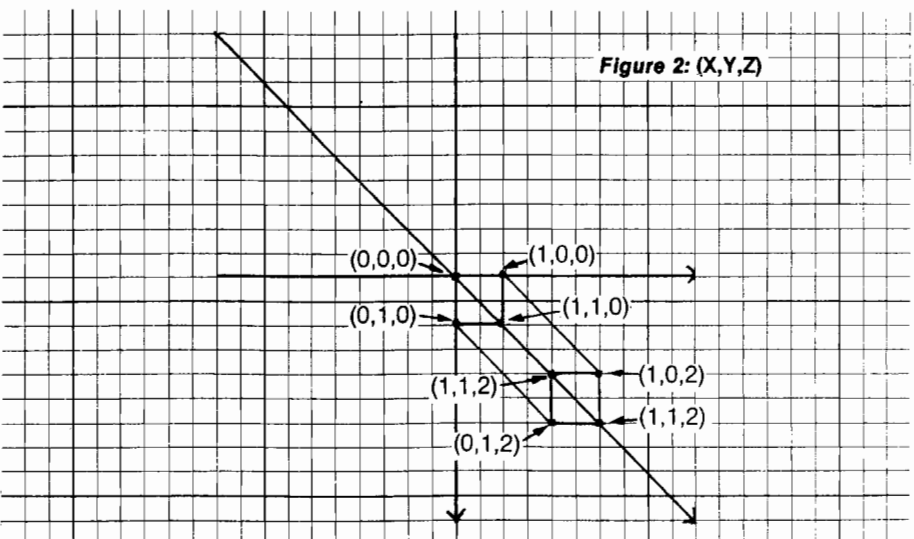
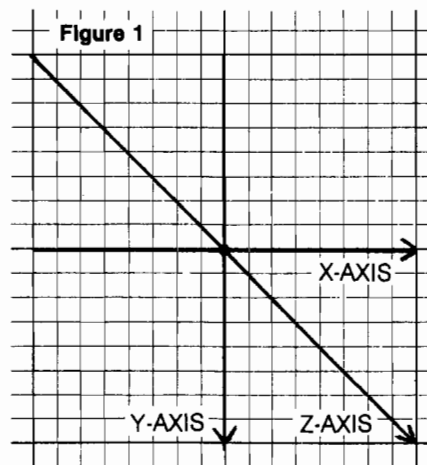

of axis definition. Refer back to figure 1. Call rotation about the Z axis — Roll, about the X axis — Pitch, and about the Y axis — Yaw. The program does a Yaw rotation only.

The trick is in the matrix multiply. If you let a given corner's coordinates be X1,Y1,Z1, then

$$\begin{pmatrix} X2 \\ Y2 \\ Z2 \end{pmatrix} = \begin{pmatrix} \text{ROTATION MATRIX} \end{pmatrix} \times \begin{pmatrix} X1 \\ Y1 \\ Z1 \end{pmatrix}$$

where X2,Y2,Z2 is that point's new, rotated coordinates.

If you don't understand that, don't worry. You'll be able to just plug numbers; you won't need to understand it.

The rotation matrix above is defined in lines 620 through 720. The angle for the sine and cosine call comes from line 450 where degrees are incremented by 15 each time through the loop and then converted to radians.

The choice of where the sine and cosine terms go in the rotation matrix determines whether the rotation is Roll, Pitch, or Yaw. Looking at the program, see that for Yaw

$$\text{DIM RT}(3,3) = \begin{pmatrix} c(\text{Yaw}) & 0.0 & s(\text{Yaw}) \\ 0.0 & 1.0 & 0.0 \\ -s(\text{Yaw}) & 0.0 & c(\text{Yaw}) \end{pmatrix}$$

How to run a listing in MICRO's Software/Hardware

The Software and Hardware Catalogs are provided as a service both to our readers and to the manufacturers. These entries are not MICRO reviews, but descriptions provided by the manufacturer.

To run a free listing in either catalog, a company fills out the appropriate form or merely mails in their material in the same format that appears in the magazine.

We try to limit entries to one company per month, on a first-come-first-serve basis.

If you sell products our readers should know about, write to Software/Hardware Catalog, MICRO, P.O. Box 6502, Chelmsford, MA 01824.

Listing 1

```

RPM *****
REM ROTATE TUTORIAL
REM BY C. WILLIAMS
REM COPYRIGHT 1982
REM BY C. WILLIAMS
REM *****

10 DIM CO(3),C(3)
20 DIM I1(12),I2(12)
30 DIM RT(3,3)
40 DIM CRNR(3,8)
50 DIM XP(8),YP(8)
60 DIM D(3)
65 REM READ EDGE-START POINTS INTO I1
70 FOR I = 1 TO 12
90 READ A
90 I1(I) = A
100 NEXT
110 DATA 1,2,3,4,5,6,7,8,1,2,3,4
115 REM READ EDGE-END POINTS INTO I2
120 FOR I = 1 TO 12
130 READ B
140 I2(I) = B
150 DATA 2,3,4,1,6,7,8,5,5,6,7,8
160 NEXT
165 REM DEFINE 3-D POSITION OF CORNERS
170 CRNR(1,1) = 0.
180 CRNR(2,1) = 0.
190 CRNR(3,1) = 0.
200 CRNR(1,2) = 0.
210 CRNR(2,2) = 1.
220 CRNR(3,2) = 0.
230 CRNR(1,3) = 1.
240 CRNR(2,3) = 1.
250 CRNR(3,3) = 0.
260 CRNR(1,4) = 1.
270 CRNR(2,4) = 0.
280 CRNR(3,4) = 0.
290 CRNR(1,5) = 0.
300 CRNR(2,5) = 0.
310 CRNR(3,5) = 2.
320 CRNR(1,6) = 0.
330 CRNR(2,6) = 1.
340 CRNR(3,6) = 2.
350 CRNR(1,7) = 1.
360 CRNR(2,7) = 1.
370 CRNR(3,7) = 2.
380 CRNR(1,8) = 1.
390 CRNR(2,8) = 0.
400 CRNR(3,8) = 2.
405 REM LINE 410 SETS VARIABLES FOR SPEED
410 P7 = .707:OE = 1:TW = 2:TR = 3:TT = 30:SF = 75:FV = 15:EI = 8:U = 150
420 HCOLOR= 3
430 HOME : VTAB 5: INPUT "ENTER INITIAL ROTATION ANGLE ":AG
440 RAD = 3.14159 / 180.
445 REM THE LOOP BEGINS HERE WITH ANGLE INCREMENT
450 AG = AG + FV:AG = AG * RAD
460 GOSUB 620: REM RT DEFINED
470 GOSUB 740: REM MATRIX MULTIPLY
475 REM THIS LOOP DOES THE 3-D-->2-D PROJECTION, PLUS SCREEN SCALING
480 FOR I = OE TO EI
490 XP(I) = CRNR(OE,I) + P7 * CRNR(TR,I)
500 YP(I) = CRNR(TW,I) + P7 * CRNR(TR,I)
510 XP(I) = (XP(I) * TT) + U
520 YP(I) = (YP(I) * TT) + SF
530 NEXT
535 REM ERASE OLD BOX, FULL SCREEN
540 CLR : POKE - 16302,0
545 REM DRAW IT, PLUS THE EDGES
550 FOR I = 1 TO 12
560 P1 = I1(I)
570 P2 = I2(I)
580 HPLOT XP(P1),YP(P1) TO XP(P2),YP(P2)
590 NEXT
600 GOTO 450
610 END
615 REM SUBROUTINE AT 620 DEFINES RT
620 CANGLE = COS (AG)
630 SANGLE = SIN (AG)
640 FOR I = 1 TO 3
650 FOR J = 1 TO 3
660 RT(I,J) = 0.
670 NEXT J: NEXT I
680 RT(1,1) = CANGLE
690 RT(2,2) = 1.
700 RT(3,3) = CANGLE
710 RT(1,3) = SANGLE

```

(contin)

Listing 1 (continued)

```

720 RT(3,1) = ( - SANGLE)
730 RETURN
735 REM SUBROUTINE AT 740 DOES X,Y,Z GET
740 FOR I = OE TO EI
750 FOR J = OE TO TR
760 C(J) = CRNR(J,I)
770 NEXT J
780 GOSUB 840: REM MM3
790 CRNR(OE,I) = CO(OE)
800 CRNR(TW,I) = CO(TW)
810 CRNR(TR,I) = CO(TR)
820 NEXT : RETURN
830 END
835 REM LINE 840 STARTS THE MATRIX MULT.
840 FOR K = 1 TO 3
850 D(K) = 0.
860 NEXT K
870 FOR II = OE TO TR
880 FOR J = OE TO TR
890 D(II) = D(II) + RT(II,J) * C(J): NEXT J
900 NEXT II
910 FOR II = OE TO TR
920 CO(II) = D(II)
930 NEXT II
940 RETURN
    
```

doesn't matter. Just rearrange lines 680 through 720 to produce arrays as shown above and you can rotate any way you wish.

That's all there is to 3-D rotation. I cringe as I say that because there are all sorts of things to be reckoned with. Refraction, shading, and hidden lines and objects are not topics to be discussed in an article with a title like this one. But the program here is a good foundation.

There is room for improvement, of course. The more adventuresome readers might try defining other 3-D shapes and then rotating them. The subroutines are all there. Or you might work for speed; a more fluid update would certainly be a plus. Let me know what you come up with.

If you'd like to do Pitch rotations, rearrange the array to look like this:

$$\text{DIM RT}(3,3) = \begin{pmatrix} 1. & 0.0 & 0.0 \\ 0.0 & c(\text{Pitch}) & -s(\text{Pitch}) \\ 0.0 & s(\text{Pitch}) & c(\text{Pitch}) \end{pmatrix}$$

And for Roll rotations, like this:

$$\text{DIM RT}(3,3) = \begin{pmatrix} c(\text{Roll}) & s(\text{Roll}) & 0.0 \\ -s(\text{Roll}) & c(\text{Roll}) & 0.0 \\ 0.0 & 0.0 & 1.0 \end{pmatrix}$$

If you don't know matrix algebra, it

Mr. Williams is an electrical engineer/writer. He may be contacted at 5676 S. Meadow Lane #101, Ogden, UT 84403.

MICRO

Decision Systems

Decision Systems
P.O. Box 13006
Denton, TX 76203

SOFTWARE FOR THE APPLE II*

ISAM-DS is an integrated set of Applesoft routines that gives indexed file capabilities to your **BASIC** programs. Retrieve by key, partial key or sequentially. Space from deleted records is automatically reused. Capabilities and performance that match products costing twice as much.
\$50 Disk, Applesoft.

PBASIC-DS is a sophisticated preprocessor for structured **BASIC**. Use advanced logic constructs such as **IF...ELSE...**, **CASE**, **SELECT**, and many more. Develop programs for Integer or Applesoft. Enjoy the power of structured logic at a fraction of the cost of **PASCAL**.
\$35 Disk, Applesoft (48K, ROM or Language Card).

DSA-DS is a dis-assembler for 6502 code. Now you can easily dis-assemble any machine language program for the Apple and use the dis-assembled code directly as input to your assembler. Dis-assembles instructions and data. Produces code compatible with the S-C Assembler (version 4.0), Apple's Toolkit assembler and others.
\$25 Disk, Applesoft (32K, ROM or Language Card)

FORM-DS is a complete system for the definition of input and output forms. **FORM-DS** supplies the automatic checking of numeric input for acceptable range of values, automatic formatting of numeric output, and many more features.
\$25 Disk, Applesoft (32K, ROM or Language Card).

UTIL-DS is a set of routines for use with Applesoft to format numeric output, selectively clear variables (Applesoft's **CLEAR** gets everything), improve error handling, and interface machine language with Applesoft programs. Includes a special load routine for placing machine language routines underneath Applesoft programs.
\$25 Disk, Applesoft

SPEED-DS is a routine to modify the statement linkage in an Applesoft program to speed its execution. Improvements of 5-20% are common. As a bonus, **SPEED-DS** includes machine language routines to speed string handling and reduce the need for garbage clean-up. Author: Lee Meador
\$15 Disk, Applesoft (32K, ROM or Language Card)

(Add \$4.00 for Foreign Mail)

*Apple II is a registered trademark of the Apple Computer Co

PET / CBM™

SOFTWARE SELECT!

8032
DISPLAY

OR

4032
DISPLAY

FROM THE KEYBOARD OR PROGRAM
NOW RUN WORD PRO 3 OR WORD PRO 4

FROM THE SAME MACHINE

Available for either 4000 or 8000 Series

ALSO:

For **2001 / 3000** Series Computers

Operate these Models in a Full **8032** Like
Display For Word Pro 4*

and all other 80 Column Software

All installation instructions included.

EXECOM CORP.

1901 Polaris Ave.
Racine, WI 53404
Ph. 414-632-1004

PET/CBM a trademark of Commodore Business Machines
*trademark of Professional Software, Inc.

HARDWARE **NEW**
201 838-9027

THE TACKLER™
 DUAL • MODE PARALLEL INTERFACE FOR THE APPLE®
 2 BOARDS IN ONE FOR NO MORE COMPATIBILITY PROBLEMS!

An intelligent board to provide easy control of your printer's full potential. Plus a standard parallel board at the flip of a switch -- your assurance of compatibility with essentially all software for the APPLE®. Hires printing with simple keyboard commands that replace hard to use software routines. No disks to load. Special features include inverse, doubled, and rotated graphics and many text control features, available through easy keyboard or software commands.

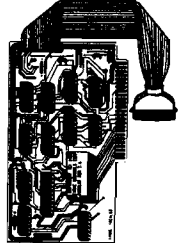

It's simple to print HIRES graphics from an APPLE computer with The Tackler from TYMAC. This is the first truly universal parallel interface! Plus the ROM for your specific printer. Sophisticated intelligence when you need it, total compatibility that never lets you down. Change printers -- no need to buy another board. Just plug in one of our ROM'S and you're all set. ROM'S available for Epson, C. Itoh, NEC, and Okidata -- others available soon. You've asked us to make the TACKLER better than the others and we did. **\$159.00***

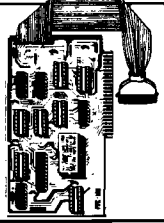

UPGRADEABLE PARALLEL PRINTER CARD

A Universal Centronics type parallel printer board complete with cable and connector. This unique board allows you to turn on and off the high bit so that you can access additional features in many printers. Easily upgradeable to a fully intelligent printer board with graphics and text dumps. Use with EPSON, C. ITOH, ANADEX, STAR-WRITER, NEC, OKI and others with standard Centronics configuration. **\$139.00**

THE PERFORMER PRINTER FORMATTER BOARD

for Epson, OKI, NEC 8023, C.I.TOH 8510 provides resident HIRES screen dump and print formatting in firmware. Plugs into Apple slot and easy access to all printer fonts through menu with PR# command. Use with standard printer cards to add intelligence. **\$49.00** specify printer.



THE MIRROR FIRMWARE FOR NOVATION APPLE CAT II®
 The Data Communication Handler ROM Emulates syntax of an other popular Apple Modem product with improvements. Plugs directly on Apple CAT II Board. Supports Videx and Smarterm 80 column cards, touch tone and rotary dial, remote terminal, voice toggle, easy printer access and much more. **List \$39.00** Introductory Price **\$29.00**

DOUBLE DOS Plus

A piggy-back board that plugs into the disk-controller card so that you can switch select between DOS 3.2 and DOS 3.3. DOUBLE DOS Plus requires APPLE DOS ROMS. **\$39.00**

SOFTWARE

NIBBLES AWAY II

AGAIN! Ahead of all others.

- **AUTO-LOAD PARAMETERS** . . . Free's the user from having to Manually Key in Param values used with the more popular software packages available for the Apple II.
- **EXPANDED USER MANUAL** . . . incorporates new Tutorials for all levels of expertise; Beginners Flowchart for 'where do I begin' to 'Advanced Disk Analysis' is included.
- **TRACK/SECTOR EDITOR** . . . An all new Track/Sector Editor, including the following features: Read, Write, Insert, Delete Search, and impressive Print capabilities!
- **DISK DIAGNOSTICS** . . . Checks such things as: Drive Speed, Diskette Media Reliability, and Erasing Diskettes.
- **HIGHEST RATED** . . . Best back up Program in Softalk Poll (Rated 8.25 out of 10).
- **CONTINUAL UPDATES** . . . Available from Computer Applications and new listings on the source.



\$69.95

Super PIX HIRES SCREEN DUMP ---

The Software package that will allow your printer to dump page 1 or page 2 of the Apple Hires screen horizontally or vertically. Use with EPSON® MX-80 with or without GRAFTRAX® Roms, MX-70 - OKI® Microline 80, 82, 83, 82A, 83A - C. ITOH® 8510 and NEC 8023A. Requires Tymac Parallel Printer Board PPC-100 . . . **\$24.95.**

APPLE LINK - A versatile modem utility that provides the Apple user the ability to transfer disk files and software over the phone. Only one package needed for full transfers. Compatible with all DOS file types. **\$59.00** (requires Hayes Micro Modem)

THE APPLE CARD - Two sided 100% plastic reference card Loaded with information of interest to all Apple owners. **\$3.98**

MICRO-WARE DIST. INC.
 P.O. BOX 113 POMPTON PLAINS, N.J. 07444
Dealer and Distributor Inquires Invited.

6502 DEBUG!
FAST 'n EASY
 The PTD Language Way

```
05 LOC1 = $7C80
10 PC = $3FC7
20 LABEL: STEP 100 NODISP
30 IF X<$3E OR @LOC1#17 THEN GOTO LABEL
40 PRINT "HERE IS THE CULPRIT"
50 SHOW<100
```



PTD-6502 is a high speed, compiled BASIC-like language, light years ahead of the Apple II Single Stepper and far more sophisticated than any other 6502 debugger available. It allows you to sit back effortlessly while your computer glides through your code at a thousand instructions per second looking for your bugs. Or you can select a slower speed with updated display of memory. A paddle-controlled single stepper mode is also available. At either of the slower speeds, the PTD-6502 monitors and saves the last 128 instructions executed for review at any time.

Virtually unlimited breakpoint complexity is permitted with the PTD-6502. IF statements with mixed AND's and OR's can be created to test conditions such as memory change, memory = value, instruction location, . . . and many others. You can have as many named breakpoints as you wish in both ROM and RAM.

Some other features of the PTD-6502 include • Fast subroutine execution. • Hex calculator/converter. • Hex/ASCII memory dump. • Up to 16 machine language cycle timers. • Ability to monitor specific labeled areas in memory while stepping. • Effective address. • Accessible monitor commands. • A documented module for relocation of the PTD-6502 to virtually any location (source code supplied).

The debugging program shown on the monitor is a simple example; it could be far more complex. If you can think of it, you can probably scan for it at 1000 instructions per second. If you're a professional, the PTD-6205 can pay for itself in the first few hours of use. If you're a novice, you'll soon be debugging like a pro.

ORDER: PTD-6502 Debugger
 including DOS 3.3 Disk and instruction manual **\$49.95**

(Note that disk is not copy protected. Order only one for each business or institution.) In California, add 6.5% sales tax.
 PTD-6502 requires Autostart ROM for fast breakpoint.

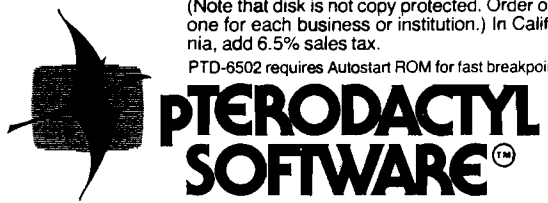

1452 Portland Ave. • Albany CA 94706 • (415) 525-1605

From Here to Atari

By Paul Swanson

We are pleased to introduce our new Atari Column. Paul Swanson has published articles in several microcomputer magazines and has authored a book on disk techniques. He runs his own software consulting firm and markets a full-size keyboard for the Atari 400.

The Atari has two microprocessors instead of one, unlike what you would find in most systems. The main processor is the 6502. Atari, Inc., custom-made the second processor, ANTIC, which is used to control just the graphics screen. A few other custom chips in the Atari are not full microprocessors, but you can control them through the hardware registers.

Taking advantage of all the Atari's special hardware can be quite complicated. Fortunately, because of the various graphics modes available, much of this hardware can be accessed through BASIC without knowing very much about the hardware itself.

You can write simple programs using the information in the BASIC Reference Manual supplied with the BASIC cartridge. More complex programs that take advantage of Atari's special chips require more information. I will supply you with details of this special hardware in upcoming columns.

Each month's column will focus on some feature of Atari's hardware. I intend to take these topics from letters I receive, so if you have questions or need more information on a specific function, send me a letter at 97 Jackson St., Cambridge, MA 02140. (If you don't want your name mentioned, be sure to note that in your letter. I will include excerpts from letters in my columns.)

In addition to answering questions concerning the Atari, this column will also contain information on new hardware and software from Atari and other manufacturers. Already available from second sources are memory boards for both the 800 and the 400. The 32K board (for both) has been available from several different companies for over a year now. There is also 48K on a single card that you can plug into your 400.

I've heard of a 64K board but haven't seen it yet. The Atari can't address 64K directly because of the 16K reserved for the operating system ROM and the hardware registers. The 64K board is bank-selectable so it doesn't exceed the 48K allowed. Available pseudo disks give you 128K of memory that you can access as if it were a disk.

Many new products have been announced for the Atari, and many are about to be announced. Much of the new software available is in response to Atari Inc.'s interest in home educational applications. *My First Alphabet*, by Fernando Herrera, is still one of the best educational software packages available for younger children. A new program called *Master Type*, from Lightning Software, makes an interesting spaceship game out of learning touch typing. If you want to learn how to type, you may want to get your local computer store to demonstrate this program for you. It is listed at \$39.95, requires 32K and a disk drive, and keeps your interest with 17 levels of complexity. These two software packages, as well as the memory boards, are available at most computer stores that carry Atari.

This column, on occasion, will try to clarify conflicting rumors. For example, I have heard three or four people asking about the "special vector" you can use in the Atari to get rid of the key click. I can appreciate the need for eliminating that noise — it seems much louder when everyone else is asleep — but I disassembled part of the operating system looking for the keyboard click and found no place to POKE anything that would eliminate it. The part in question is in ROM and you can't alter ROM with a POKE. It doesn't check with any RAM locations before the JSR (Jump to SubRoutine) that produces the click. The only ways I can see to eliminate the click include physically disconnecting the keyboard speaker or writing your own keyboard handler. Even writing the keyboard handler would not eliminate the click under every possible condition; you have to initiate the handler every time one of a variety of different things happens.

Future columns may also include a listing of a short utility program (BASIC) that is in the public domain. No

machine-readable copies will be available. If you really don't want to type it in, check with your local user group to see if anyone already typed it in.

My December column will feature the Atari Regional Software Acquisition Centers; January will include available technical literature. December's column will be of particular interest if you plan to market any of your Atari software. January's topic covers places where you can find lists and explanations of all those special memory locations that you need to develop fancier software.

MICRO

It Pays to Write for MICRO!

Get paid for your ideas: write for MICRO! Thousands of people read MICRO every month. MICRO is sold in computer stores and on newsstands worldwide. Send for a copy of our Writer's Guide now. Our author payment rate is competitive with the leading magazines in the industry.

We welcome articles on any aspect of 6502/6809/68000 hardware and software for the Apple, Atari, CBM/PET, TRS-80 Color Computer, VIC, OSI, 6809, or 68000. Topics for upcoming issues are: Programming languages (besides BASIC), Communications, Operating Systems, and new Computers.

What's eating your Apple?

Find out with Apple-Cillin II™

It's a fact of computer life. Software and hardware interact. If there's a problem eating your Apple, you can spend hours trying to find out whether software or hardware is the culprit. Unless you have Apple-Cillin II.

Apple-Cillin II is a comprehensive diagnostic system developed by XPS to check the performance of your Apple II computer system. Apple-Cillin II contains 21 menu driven utilities to thoroughly test the operation of your system, and either identify a specific problem area or give your system a clean bill of health. Quickly and easily.

Apple-Cillin II works with any 48K Apple system equipped with one or more disk drives.

To order Apple-Cillin II - and to receive information about our other products - Call XPS Toll-Free: 1-800-233-7512. In Pennsylvania: 1-717-243-5373.

Apple-Cillin II: \$49.95. PA residents add 6% State Sales Tax.



XPS, Inc.
323 York Road
Carlisle, Pennsylvania 17013
800-233-7512
717-243-5373

NEW SOFTWARE for TRS 80 Model III and the Color Computer

■ **Church Contribution System**
designed to simplify and facilitate the tedious chore of recording envelopes. Provides a variety of reports. Maintains its own data-files. Only **\$150**

■ **Data Base Manager**
designed to help organize all your data and provide you with meaningful reports. Add or delete any information. New files can be created and old information transferred. Only **\$150**

■ **Single Entry Ledger**
designed as an uncomplicated control of finances for home or small business. Add, delete, edit at any time. Compatible with DBM. Only **\$95**

Write or phone for complete software price list.



2457 Wehrle Drive
Amherst, NY 14221
716/631-3011

CSE means OSI Custom After Market Software for C1P and C4P machines

*Basic Enhancer:

Renumber, Auto Sequencer, Screen Control functions, and tape 1/0 system that is faster and has file names

C1P \$21.95
C4P \$29.95

Modified Monitor Rom Chip:

Now get indirect jump-capabilities just like those in the C1P and for no extra charge CSE will burn in your machines serial number \$16.95

*NOTE: The C4P version of the Basic Enhancer includes the modified monitor Rom chip required for proper program functioning.

This is only a partial listing of our products. Write us for information on new disk programs or send \$2 for catalog. Please include \$2.00 shipping and handling with orders.

**Computer
Science
Engineering**

Box 50 • 291 Huntington Ave. Boston 02115

6809 Bibliography

78. Color Computer News, Issue No. 10 (July, 1982)

- Jackson, Jesse W., "TTYPELOG," pg. 58-60.
A utility for the Color Computer to log tape information to your printer.
- Rouse, Alan, "Mortgage," pg. 62-64.
A "What If" program for the Color Computer.
- Eichman, Steve, "Shaplist," pg. 65-67.
An Inventory/File program for the 6809-based Radio Shack Color Computer.
- Aker, Jack L., "BASIC Program Line Mover," pg. 69-70.
A utility for a Color Computer with Extended BASIC, and 16K or 32K memory.
- Becus, Georges A., "TRACETXT Listing Produced by PRIN-TXT CTRACE," pg. 71-75.
A trace utility for the 6809-based Color Computer.
- Pretty, Richard, "A Pull on Your 'Art' Strings," pg. 77.
A simple string art program for the TRS-80 Color Computer.
- Barnes, Mark, "Gold Mine," pg. 78-81.
A graphics maze game for the 6809-based Color Computer.
- Wright, Darrel, "Convert That File," pg. 83-84.
A utility program to convert a Telewriter text file to a standard ASCII data file or vice versa. For the TRS-80 Color Computer.
- Peterson, Russell M., II, "Exploring Graphics Modes," pg. 87-88.
Using the SDS80C Editor/Assembler on the TRS-80 Color Computer.

79. 80-U.S. Journal, 5, No. 7 (July, 1982)

- Roberts, R.N., "Togetherness," pg. 88-89.
Tape merge for the 6809-based TRS-80 Color Computer.
- Causar, R. Shane, "17K of RAM," pg. 94-95.
Squeeze extra space from memory on your TRS-80 Color Computer. This is done by saving 1K of memory out of a program requiring 16K of memory.

80. The Rainbow, 2, No. 1 (July, 1982)

- Parkman, Bob, "Silent Answer," pg. 4.
A driver to interface a TI Silent 700 with the 6809-based TRS-80 Color Computer.
- Mir, Jorge, "Let's Go On A Simple Rainbow Adventure," pg. 9-17.
An adventure-type program for the Color Computer.
- Blyn, Steve, "Design Programs to Help Children Learn," pg. 18-19.
BEEPEROO is a simple program for the Color Computer which can be used to reinforce the concept of simple addition of three-digit numbers.
- Penrose, Paul, "Playing Around With Your 80C," pg. 22.
Playing music with the TRS-80 Color Computer.
- Morgan, Alan J., "Synchronizing with Your SAM Chip," pg. 24-25.
Using the 6883 SAM chip with the 6809-based Color Computer.
- Nolan, Bill, "Make Magic Rings on Magic 80C," pg. 27-29.
For addicts of fantasy role-playing programs, this Color Computer listing rolls up magic rings for you.
- Rutledge, E.P., "Disk File Helps You Keep Track of Everything," pg. 30-33.
A utility for the 6809-based Color Computer.
- Lewandowski, Dennis S., "Let's Soak Up Some Assembly," pg. 38-39.
A second tutorial on 6809 assembly-language programming.
- Ebbert, Jim, "Is There Any Escape from No Escape?," pg. 42-45.
A space-navigation graphics program for the Radio Shack TRS-80 Color Computer.

Waclo, John, "The NFL Report Can Choose This Fall's Winners," pg. 50-64.

Put the National Football League on your Color Computer.

81. Compute! 4, No. 1 (January, 1982)

Mansfield, Richard, "BRANCH NEVER and QUIF Assembling on SuperPET," pg. 146-149.
An instructional article for SuperPET users.

82. Microcomputing, 6, No. 8 (August, 1982)

Whitman, James A., "Pascal and BASIC Square Off, Continued," pg. 22.
Benchmark tests including data on the 6809-based TRS-80 Color Computer.

83. MICRO, No. 51 (August, 1982)

Steiner, John, "Interfacing the Color Computer," pg. 33-36.
Circuits to interface the TRS-80 Color Computer to an RS-232 port and a motor control relay are presented. A Morse Code send/receive program is included as a demonstration.

Staff, "MICRO Reviews in Brief," pg. 39-41.
Reviews include discussion of a disassembler for the 6809 and the Compuvoice Synthesizer for the 6809-based Color Computer.

Dial, Wm. R., "6809 Bibliography," pg. 118.
Some 26 items relating to 6809 literature are listed.

84. 80 Micro, No. 52 (September, 1982)

Miller, Franklyn D., "The Colorful Computer — Part II," pg. 152-162.
Twenty programs for the 6809-based TRS-80 Color Computer.

Tucker, Richard, "Cheaper Upgrade," pg. 186-188.
Do it yourself and save substantial cost in converting a 4K Color Computer, 8K Color BASIC to a 16K Extended Color BASIC by installing the new ROM yourself.

Norman, Scott L., "Pascal Goes Color," pg. 198-202.
Compiled Pascal for the Color Computer is discussed.

Sprouse, Gerald, "Joystick Paintbrush," pg. 230-232.
Use the Color Computer like a drawing board, employing two programs listed.

Osborne, Frank H., "Conversion," pg. 238-240.
Rewrite Level II BASIC programs to run on the 6809-based Color Computer.

Heusinkveld, John, "PCLEAR 0," pg. 282.
Make hi-res graphics use high memory on the 6809-based Color Computer.

85. Personal Computer, 5, No. 8 (August, 1982)

Curtis, Mike and Whelan, Joe, "The Dragon," pg. 112-116.
Dragon 32 is a new 6809-based British microcomputer with full color, 32K RAM, 16K Microsoft BASIC, etc.

86. Color Computer News, Issue No. 11 (August, 1982)

Morrow, Ken, "Program Relocation," pg. 19-21.
Discussion and listing for program relocation on the 6809-based TRS-80 Color Computer.

Bassen, Howard, "Optimizing High-Resolution Animated Games in Extended BASIC — Part 2," pg. 23-26.
Tutorial on the use of game routines with several demo listings.

Lester, Lane P., "Motion Picture Programming and the Teacher," pg. 27-28.
Animation on the Color Computer.

MICRO™

Software Catalog

Name: **Adventure to Atlantis**
System: Apple II
Memory: 48K
Language: Machine Code
Hardware: One disk drive
Description: This game combines the best features of adventure games, arcade games, and fantasy role-playing games. *Adventure to Atlantis* is a sequel to *Odyssey: The Complete Adventure*. The struggle between the forces of magic (The High One) versus the forces of science (The Atlanteans) continues. The game uses four methods to grab the player's attention: high-resolution color graphics and animation, sound effects to enhance the action, random events at all stages of the adventure, and embedded arcade-like action.
Price: \$40.00
Includes one floppy disk.
Author: Robert C. Clardy
Available:
Synergistic Software
830 N. Riverside Drive
Suite 201
Renton, WA 98055

Name: **The Business Bookkeeping System™**
System: Apple II, Apple II Plus, Apple III
Memory: 48K
Language: Applesoft BASIC
Hardware: Two disk drives, video monitor, printer, emulation mode (Apple III)
Description: *The Business Bookkeeping System* is a cash accounting system that includes general ledger, customer activity, vendor activity, and employee activity. It contains eleven general ledger reports, five customer activity reports, four vendor activity reports, and six employee activity reports.
Price: \$395.00
Includes indexed documentation, ten diskettes, toll-free software support.
Available:
Dakin 5 — Authorized Apple dealer

Name: **Astro Blast**
System: TRS-80 Color Computer
Memory: 16K/cassette
32K/disk
Language: Assembly
Hardware: Joysticks
Description: *Astro Blast* is a space "shoot-em-up" featuring the highest resolution graphics, lots of color, and dramatic sound effects. Wave after wave of alien attackers are a challenge to your joystick and fire-button skills. Three selectable skill levels coupled with automatic game acceleration challenge both novice and professional.
Price: \$24.95/cassette
\$29.95/disk
Includes full instructions.
Author: Ron Krebs
Available:
Mark Data Products
23802 Barquilla
Mission Viejo, CA 92691

Name: **INTROL-C/6809 Compiler System**
System: FLEX, UniFLEX, OS-9, CP/M
Memory: 56K
Language: C
Description: Powerful C language compiler develops programs in C for systems running under FLEX, UniFLEX, or OS-9; also as cross-software for CP/M-based development systems. Full-blown implementation provides full support of all standard C except initializers and bitfields. Written entirely in C itself, Introl-C includes a C compiler, 6809 assembler, linking loader, standard runtime library and library manager, and unsurpassed code efficiency.
Price: From \$400.00
Includes diskette, user manual, one-year maintenance/update.
Author: Richard D. Pennington
Available:
Introl Corp.
647 W. Virginia St.
Milwaukee, WI 53204
(414) 276-2937

Name: **Frazzle**
System: Apple II or Apple II Plus
Memory: 48K
Language: 6502 Assembly
Hardware: Disk Drive (Dual DOS 3.2/3.3)
Description: Muse announces the release of *Frazzle*, the computer game that puts you in the future. The scene begins in space, with you commanding a Frazzle Force Ship that is suddenly under attack by Beasties. Colorful screen graphics show your position on the ship's radar screen, the force field surrounding you, and odd-shaped Beasties zooming in. Your ammunition is pulsating Energy Probes, which beep and flash as you release them on the screen. You must stop the Beasties while avoiding collisions with them, with the walls of the force field, and with your own ammunition. Sound effects include the electronic hum of a radar monitor and the squish of Energy Probes dissolving the Beasties.
Price: \$24.95
Author: J.C. Nolan
Available:
Direct from Muse and computer stores nationwide

Name: **K-Razy Kritters**
System: Atari 400/800
Memory: 8K
Language: Machine Code
Hardware: ROM Cartridge
Description: This challenging celestial adventure with ten levels of play begins with three command ships. The player's active command ship attempts to destroy free-falling alien patrol "Kritters" descending from above. Weapons include standard missiles and super-missiles. If a command ship is destroyed, a sanitation crew will remove the wreckage.
Price: \$39.95 suggested retail
Includes ROM cartridge and instruction booklet.
Author: Torre Meeder
Available:
K-Byte
1705 Austin
Troy, MI 48084
or your local computer software dealer

Name: **3D Drawing Board**
System: TRS-80 Color Computer
Memory: 16K
Language: BASIC
Description: *3D Drawing Board* is a tool for education, entertainment, or serious projects. It helps you draw objects in three dimensions, rotates them, and changes elevation, size, and distance. The drawings can be saved to tape or disk for future use.
Price: \$24.95/cassette
\$29.95/disk
Includes complete instruction manual and program with samples.
Author: Mark Laessig
Available:
Computerware
Box 668
Encinitas, CA 92024
(714) 436-3512

Name: **Computer-Aided Instruction for General Chemistry**
System: Apple, Commodore PET, TRS-80 III
Memory: 48K/Apple II
Language: Applesoft/Apple II
Hardware: Apple — DOS 3.3
PET — 4040 or 2031 disk drive
Description: A comprehensive set of 20 programs designed to supplement a course in general chemistry. Each program contains 50-70 drills, exercises, and problems (approximately 24½ hours of machine time) presented in an interactive format. The questions are randomly generated. No computer experience is necessary. Intended for introductory college level or advanced placement in high school.
Price: \$325.00
Includes four disks for the Apple II, two disks for the PET, and four or five disks for the TRS-80, and complete documentation.
Authors: William Butler
Raymond Hough
Available:
John Wiley & Sons, Inc.
Eastern Distribution Center
Order Processing Dept.
1 Wiley Drive
Somerset, NJ 08873

MICRO



Super Sale!

40% Off On Ohio Scientific Superboard II A Complete Computer System On A Board

Includes full-size 53-key keyboard, video and audio cassette interfaces; SWAP, Modem, sampler cassettes; manual; 8K BASIC-in-ROM, with 8K RAM. Requires 5-V/3 amp regulated DC power supply. 30-day limited warranty. Supply is limited. ONLY \$200.00

Plus Sensational Limited-Time Savings On Ohio Scientific C1P Series personal computers, Superboard and C1P accessories, spare replacement parts, printers, monitors, integrated circuits, and other computer-related components.

To Order

Call us directly or return order coupon with your check, money order, or Mastercard or Visa Account Number. Orders will normally be shipped within 48 hours after receipt. \$100.00 minimum order.

FREE

Sampler Cassettes with each Superboard II and C1P series order!

Taxi (Game), Electronic Equations, Loan Finance, Straight and Constant Depreciation, Uneven Cash Flows

Tiger Tank, Flip Flop, (Logic Game), Hectic, Black Jack, Master Mind



Cleveland Consumer Computers & Components

1333 S. Chillicothe Road, Aurora, OH 44202
TO ORDER: CALL 1-800-321-5805 TOLL FREE
(Ohio Residents Call 216-562-4136)

- SUPERBOARD II, \$200.00
- Send Detailed Catalog/Order Form

Name _____

Address _____

City _____ State _____ Zip _____

Payment by enclosed check or money order or charge to:

- MasterCard
- VISA

Account # _____ Expiration Date _____

Total Amount Charged or Enclosed \$ _____

Ohio Residents Add 5.5% Sales Tax. All Orders Will Be Shipped Insured By UPS Unless Requested Otherwise.

Comp Case

IS THE PERFECT GIFT FOR THE COMPUTER THAT HAS EVERYTHING

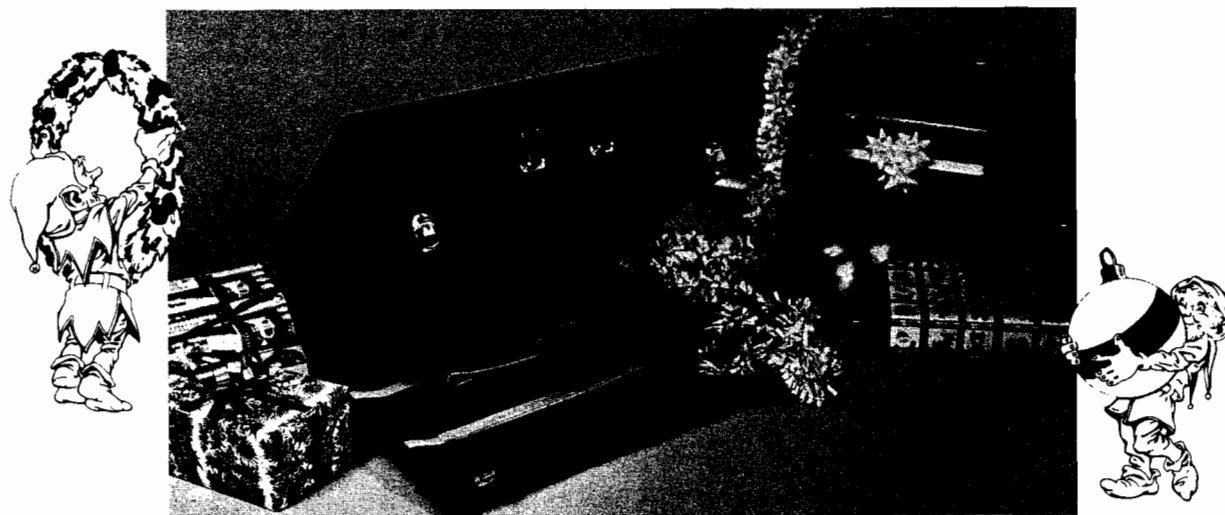

Your investment in a computer is long term. You expect many years of reliable service. Comp Case protects your investment when not in use or while transporting it from office or home. Your computer never leaves the case — you simply remove the lid, make the electrical connection, and operate. Comp Cases are available for most brands of computers and peripherals.

Comp Case is the perfect Christmas gift. Comp Cases are available in better computer stores in our area. Or call 800-848-7548 direct to receive your Comp Case in time for Christmas.



**Computer
Case
Company**

COMPUTER CASE COMPANY • 5650 INDIAN MOUND COURT • COLUMBUS, OHIO 43213

MICROTM

Hardware Catalog

Name: **Joystick**
System: Apple II Plus
Description: This joystick is a joy to use. Its heavier metal case doesn't slip or slide like plastic. And the very sensitive switch is guaranteed for 1,000,000 pushes. Better control and reliability.

Price: \$59.95

Available:
Gimix Inc.
1337 W. 37th Pl.
Chicago, IL 60609
(312) 927-5510

Available:
Datamost, Inc.
9748 Cozycroft Avenue
Chatsworth, CA 91311
(213) 709-1202
or computer stores

Name: **Apple-Mate**
Hardware: Floppy disk drive
Description: Add this floppy disk drive to your Apple computer. It is 100% compatible with the Apple Disk II drive, and with all Apple software including half-track-protected software.

Price: \$335.00
Includes cable.

Available:
Quentin Research, Inc.
19355 Business Center Dr.
Northridge, CA 91324
(213) 701-1006

Name: **Freedom 100**
Description: This is an ASCII CRT terminal. It has a block mode, ten function keys, 15 graphics characters with full attributes, one-page screen memory, and separate attributes buffer.

Price: \$595

Available:
Liberty Electronics, USA
100 Clement Street
San Francisco, CA 94118

Name: **Gimix Intelligent Serial I/O Processor Board**

System: Gimix 6809
Memory: 128K minimum
Hardware: S-30 I/O bus board

Description: This board reduces the number of interrupts between user terminals and the host CPU by buffering data transfers between system and users and preprocessing of the data. It has on-board CPU and RAM/EPROM memory, three

RS-232C serial ports, a Z8038 F10 I/O interface, and supports up to three users. It requires on-board software and OS drivers.

Price: \$438.11
Includes 4K RAM. (Software is optional.)

Available:
Gimix Inc.
1337 W. 37th Pl.
Chicago, IL 60609
(312) 927-5510

Name: **The Spectrum Stick**

System: TRS-80 Color Computer
Memory: 4K and up
Hardware: Joystick
Description: This new joystick has a hair-trigger firebutton and swivel-ball type component stick. The extra-long cable makes it easier to put your joystick where you want it. Red LED indicator reminds you to shut off the Color Computer.

Price: \$39.95 plus \$2.00 S/H
Includes 10-foot cable, red LED indicator, joystick, firebutton, case, and joystick control

Available:
Spectrum Projects
93-15 86 Drive
Woodhaven, NY 11421
(212) 441-2807 Voice
(212) 441-3755 Computer

Name: **Disk-O-Tier**
System: All disk-based systems
5¼" or 8"

Description: A convenient desktop holder for diskettes that prevents damage by laying them flat, but allows full visibility of all diskettes. It is molded of durable NAS smoked plastic, and holds eleven diskettes.

Price: \$9.50 plus \$2.00 postage
\$19.00 for twin-pack, ppd.

Available:
ETS Center
Dept. 97
Box 651
35026-A Turtle Trail
Willoughby, OH 44094
(216) 946-8479

Name: **Pro-Guard 8" Floppy Controller**

System: Apple III
Memory: 2.2 megabytes
Hardware: 8" Shugart-compatible drives

Description: *Pro-Guard 8" Floppy Controller* adds up to 2.2 megabytes of removable media and provides backup for Apple profile. IBM 3740 format allows 8" disks to be read on other computers, including IBM mainframes.

Price: \$695
Includes DOS, SOS, Pascal, CP/M distribution software, cables, manual.

Available:
Apple Dealers
MICRO-D
SUA, Inc.

Name: **Programmable Sound Module**

System: TRS-80 Color Computer
Memory: 4K and up
Language: BASIC
Description: *The Programmable Sound Module* is a plug-in cartridge for the Color Computer. A separate audio-microprocessor and ROM inside the cartridge combine to extend BASIC's vocabulary with a versatile sound-effects system. Complex noises can be created with short BASIC phrases and maintained independently of your program, allowing simultaneous video and audio effects.

Price: \$139.95
Includes PSM cartridge, operating system in ROM, and full instructions.

Available:
Maple Leaf Systems
Box 2190
Station "C"
Downsview, Ontario
Canada M2N 2S9

Name: **Voter 30**

System: Apple II
Language: BASIC
Description: *Voter 30* is a peripheral hardware/software package for training, marketing, and educational uses using a group response system for up to 30 participants. Each par-

ticipant gets a hand-held keypad to respond to multiple-choice questions. *Voter 30* tabulates the responses and produces a color bar chart showing the breakdown, while keeping a record of the individual station responses.

Price: \$595 for interface card with programs and manual. \$125.00 each for polling stations with cable and connectors.

Available:
Reactive Systems, Inc.
40 North Van Brunt Street
Englewood, NJ 07631
(201) 568-0446

Name: **Mini-Video #82-140**

System: 6502-based video board
Memory: 4K RAM/4K EPROM
Language: Video Display; Monitor & Tom Pittman's Tiny BASIC
Hardware: Assembled circuit board

Description: Add a video display to your AIM or other computer. It will run Tom Pittman's Tiny BASIC with the addition of the parallel keyboard, 5V power supply and video monitor. The 2716-character generator will produce 256 8x8 characters ASCII upper- and lower-case and graphic characters. The 44-pin expansion connector can be used to add up to 6K of memory or extra I/O ports. The cursor is flashing under line type. Power requirements 5 volts, 600 MA, 3 watts.

Price: \$149.95
Includes documentation and assembled board without EPROMs.

Available:
John Bell Engineering, Inc.
1014 Center Street
San Carlos, CA 94070
(415) 592-8411

MICRO

ATARI 400/800

Atari 400 and 800 are color-and-sound computers. 6502 is the main processor and ANTIC handles video. Atari 400 has a membrane keyboard and Atari 800 has a full-size typewriter keyboard.

Peripherals may include up to four disk-drive units, a cassette unit, printer, and the 850 interface module. Four programmable controller ports handle joysticks, paddles, light pens, and other accessories.

Sophisticated graphic capabilities include: 256 colors (16 may be displayed on the screen at once), 17 graphic modes (6 character and 11 map), high-resolution graphics (up to 320 x 192), and powerful player/missile graphics.

Some Useful Memory Locations on the Atari

Page 0 Locations:

Hex	Dec	Length	Name	Description
0010	016	1	POKMSK	IRQ mask
0012	018	3	RTCLOK	Real time clock 018 is hi order
0041	065	1	SOUNDR	Noisy I/O flag
0042	066	1	CRITIC	Critical I/O flag
004D	077	1	ATTRACT	Attract mode flag
0052	082	1	LMARGIN	Left margin
0053	083	1	RMARGIN	Right margin
0080	128	2 *	LOMEM	Buffer used to tokenize line of BASIC
0082	130	2 *	VNTP	Variable name table start
0084	132	2 *	VNTD	Variable name table dummy end
0086	134	2 *	VVTP	Variable value table start
0088	136	2 *	STMTAB	Statement table
008A	138	2 *	STMCUR	Current statement pointer
008C	140	2 *	STARP	String and array area
008E	142	2 *	RUNSTK	BASIC's software stack
0090	144	2 *	MEMTOP	Top of memory used by BASIC program
00BA	186	2	STOPLN	Line number of most recent stop or error
00C3	195	1	ERRSAV	Error number causing TRAP branch
00CB	203	7		Available for user machine-language programs
00D0	212	2		Value return from machine language to BASIC

* Indicates location is a vector

ANTIC Commands (Display List)

Blank line commands:

Command is $(\# \text{ lines} + 1) * 16$

Ex.: Blank 8 lines is $(8 + 1) * 16$, or $\$70 = \text{dec. } 144$

Jump instruction: $\$01 = \text{dec. } 1$ (2-byte instruction)

Jump on vertical blank = $\$41 = \text{dec. } 65$ (2-byte instruction)

Display line instruction is equal to the IR mode number ($\$02-\$0F$).

To set special features, add these values to the instructions:

Add

Hex	Dec.	For
10	16	Horizontal scroll enable
20	32	Vertical scroll enable
40	64	Load memory scan (makes it a 2-byte instruction)
80	128	Display list interrupt enable

Note: Display list interrupt can be enabled on any command, but scrolling and load memory scan can be enabled only on display commands.

ANTIC Commands (Display Modes)

Mode	IR	BASIC	Horiz. Pixels	Scan Lines		Char/Map Mode
				Per Mode Line	Colors	
02	0	40	8	1.5	C	
03		40	10	1.5	C	
04		40	8	5	C	
05		40	16	5	C	
06	1	20	8	5	C	
07	2	20	16	5	C	
08	3	40	8	4	M	
09	4	80	4	2	M	
0A	5	80	4	4	M	
0B	6	160	2	2	M	
0C		160	1	2	M	
0D	7	160	2	4	M	
0E		160	1	4	M	
0F	8	320	1	1.5	M	

GTIA:

The GTIA modes are versions of mode 8, instituted by adding 64, 128, or 192 to PRIOR.

GTIA Mode

GTIA Mode	Description
9	16 luminances of background hue
10	9 colors - uses $\$D012$ through $\$D01A$
11	16 hues of background luminance

ATARI 400/800

COLOR VALUES:

- 0 Black-gray-white
- 1 Burnt Orange
- 2 Orange
- 3 Red-orange
- 4 Red
- 5 Purple
- 6 Blue-purple
- 7 Blue
- 8 Blue
- 9 Gray-blue
- 10 Turquoise
- 11 Aqua
- 12 Green
- 13 Yellow-green
- 14 Orange-green
- 15 Orange

Default colors (SETCOLOR values):

- 0,2,8 (Orange)
- 1,12,10 (Light green)
- 2,9,4 (Dark blue)
- 3,4,6 (red)
- 4,0,0 (Black)

Joysticks:

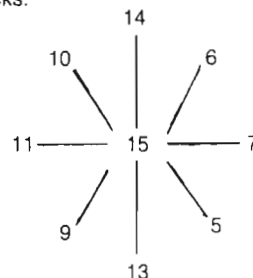

For COLORS:

POKE hue*16 + luminance into COLx

For SOUND:

POKE frequency into AUDFx

POKE distortion*16 + volume into AUDCx

Hardware Registers and Shadows

Address	Shadow	Name	Description	(R)ead or (W)rite
Hex Dec	Hex Dec			
COLORS:				
D012	53266 02C0 704	COLPM0	Player-missile 0	W
D013	53267 02C1 705	COLPM1	Player-missile 1	W
D014	53268 02C2 706	COLPM2	Player-missile 2	W
D015	53269 02C3 707	COLPM3	Player-missile 3	W
D016	53270 02C4 708	COLPF0	Playfield 0	W
D017	53271 02C5 709	COLPF1	Playfield 1	W
D018	53272 02C6 710	COLPF2	Playfield 2	W
D019	53273 02C7 711	COLPF3	Playfield 3	W
D01A	53274 02C8 712	COLBK	Playfield background	W
SOUND:				
D200	53760	AUDF1	Channel 1 Frequency	W
D201	53761	AUDC1	Channel 1 Control	W
D202	53762	AUDF2	Channel 2 Frequency	W
D203	53763	AUDC2	Channel 2 Control	W
D204	53764	AUDF3	Channel 3 Frequency	W
D205	53765	AUDC3	Channel 3 Control	W
D206	53766	AUDF4	Channel 4 Frequency	W
D207	53767	AUDC4	Channel 4 Control	W
D208	53768	AUDCTL	Audio Control	W
PLAYERS AND MISSILES:				
D000	53248	HPOSP0	Horiz. pos. Player 0	W
D001	53249	HPOSP1	Horiz. pos. Player 1	W
D002	53250	HPOSP2	Horiz. pos. Player 2	W
D003	53251	HPOSP3	Horiz. pos. Player 3	W
D004	53252	HPOSM0	Horiz. pos. Missile 0	W
D005	53253	HPOSM1	Horiz. pos. Missile 1	W
D006	53254	HPOSM2	Horiz. pos. Missile 2	W
D007	53255	HPOSM3	Horiz. pos. Missile 3	W
D008	53256	SIZEP0	Size of Player 0	W
D009	53257	SIZEP1	Size of Player 1	W
D00A	53258	SIZEP2	Size of Player 2	W
D00B	53259	SIZEP3	Size of Player 3	W
D00C	53260	SIZEM	Size of all Missiles	W
D407	54279	PMBASE	Player-missile base	W
CHARACTERS:				
D401	54273 02F3 755	CHACTL	Character control	W
D404	54276	HSCROL	Horizontal scroll	W
D405	54277	VSCROL	Vertical scroll	W
D409	54281 02F4 756	CHBASE	Character set base	W
CONTROL REGISTERS:				
D01B	53275 026F 623	PRIOR	Priority Select	W
D01D	53277	GRACTL	Graphics control	W
D20E	53774 0010 016	IRQEN	IRQ enable	W
D402	54274 0230 559	DLISTL	Display list ptr., low	W
D403	54275 0231 560	DLISTH	Display list ptr., high	W
D40E	54286	NMIEN	Non-maskable int. enabl.	W

Address	Shadow	Name	Description	(R)ead or (W)rite
Hex Dec	Hex Dec			
GAME CONTROLLER PORTS:				
D010	53264 0284 644	TRIG0	Joystick trigger 0	R
D011	53265 0285 645	TRIG1	Joystick trigger 1	R
D012	53266 0286 646	TRIG2	Joystick trigger 2	R
D013	53267 0287 647	TRIG3	Joystick trigger 3	R
D200	53760 0270 624	POT0	Paddle 0	R
D201	53761 0271 625	POT1	Paddle 1	R
D202	53762 0272 626	POT2	Paddle 2	R
D203	53763 0273 627	POT3	Paddle 3	R
D204	53764 0274 628	POT4	Paddle 4	R
D205	53765 0275 629	POT5	Paddle 5	R
D206	53766 0276 630	POT6	Paddle 6	R
D207	53767 0277 631	POT7	Paddle 7	R
D208	53768	ALLPOT	Pot port state	R
D20B	53771	POTGO	Start pot scan	W
D300	54016 0278 632	PORTA	STICK0	R
		PIORTA	STICK1	R
D300	54016	PORTA	Direction register	W
D301	54017 0280 634	PORTB	STICK2	R
		PORTB	STICK3	R
D301	54017	PORTB	Direction register	W
D302	54018	PACTL	Port A control	W
D303	54019	PBCTL	Port B control	W
MISCELLANEOUS:				
D01F	53279	CONSOL	Consol switches	R
D01F	53279	CONSOL	Keyboard speaker	W
D20A	53770	RANDOM	random number gen.	R
D20F	53775 0232 562	SKCTL	Serial port control	W
D40B	54283	VCGUNT	Vertical line counter	R
D40C	54284 0234 564	PENH	Light pen horiz. pos.	R
D40D	54285 0235 565	PENV	Light pen vert. pos.	R

Collision Registers for Players and Missiles

D000	53248	M0PF	Missile 0 - playfield	R
D001	53249	M1PF	Missile 1 - playfield	R
D002	53250	M2PF	Missile 2 - playfield	R
D003	53251	M3PF	Missile 3 - playfield	R
D004	53252	P0PF	Player 0 - playfield	R
D005	53253	P1PF	Player 1 - playfield	R
D006	53254	P2PF	Player 2 - playfield	R
D007	53255	P3PF	Player 3 - playfield	R
D008	53256	M0PL	Missile 0 - player	R
D009	53257	M1PL	Missile 1 - player	R
D00A	53258	M2PL	Missile 2 - player	R
D00B	53259	M3PL	Missile 3 - player	R
D00C	53260	P0PL	Player 0 - player	R
D00D	53261	P1PL	Player 1 - player	R
D00E	53262	P2PL	Player 2 - player	R
D00F	53263	P3PL	Player 3 - player	R

NATIONAL ADVERTISING REPRESENTATIVES

WEST COAST

The R.W. Walker Co., Inc.
2716 Ocean Park Boulevard
Suite 1010
Santa Monica, California 90405
(213) 450-9001

serving: Washington, Oregon, Idaho, Montana, Wyoming, Colorado, New Mexico, Arizona, Utah, Nevada, California, Alaska, and Hawaii (also British Columbia and Alberta, Canada).

MIDDLE ATLANTIC AND SOUTHEASTERN STATES

Dick Busch Inc.
Richard V. Busch
6 Douglass Dr., R.D. #4
Princeton, NJ 08540
(201) 329-2424

Eleanor M. Angone
74 Brookline
E. Atlantic Beach, NY 11561
(516) 432-1955

serving: New York, Pennsylvania, New Jersey, Delaware, Maryland, West Virginia, Virginia, D.C., North Carolina, South Carolina, Louisiana, Tennessee, Mississippi, Alabama, Georgia, and Florida.

NEW ENGLAND AND ALL OTHER TERRITORIES

Kevin B. Rushalko
Peterboro, New Hampshire 03458
(603) 547-2970

serving: Maine, New Hampshire, Vermont, Massachusetts, Rhode Island, Connecticut, Ohio, Kentucky, Oklahoma, Arkansas, and Texas (also any other territories not listed above).

ADVERTISING MANAGER

Cathi Bland

address materials directly to:
MICRO INK, Advertising
34 Chelmsford Street
Chelmsford, Massachusetts 01824
(617) 256-5515

Advertiser's Index

Aardvark Technical Services, Ltd.	18
ABM Products	98
Advanced Operating Systems	17
Anthro-Digital Software	8
Apex Co.	84
Apple Tree Electronics	29
Ark Computing	47
Artsci, Inc.	IFC
Aurora Software Associates	21
Bedford Micro Systems	8
CGRS Microtech	24
Cleveland Consumer Computer Components	107
Collegiate Microcomputer	77
Computech	15
Computer Case Co.	107
Computer Mail Order	64-65
Computer Marketing Service	78
Computer Science Engineering	104
Datamost	33, 34, 90, 92
Decision Systems	101
Digicom Engineering, Inc.	68
Digital Acoustics	12
D&N Micro Products, Inc.	69
Eastern House Software	61
Excort, Inc.	48
Execom Corp.	101
Genesis Information Systems Inc.	39
Gimix, Inc.	1
Hudson Digital Electronics Inc.	40
Interesting Software	73
Kilo Corp.	54
Leading Edge Electronics	BC
Logical Devices	95
Lyc0 Corp.	58
MICRObits (Classifieds)	28, 30, 31
MICRO INK	32, 82, 84
Micro Motion	68
Microsoft Consumer Products	IBC
Micro-Ware Distributing Inc.	102
M.M.S.	76
Modular Systems	77
Olympic Sales Co.	21
Optimal Technology	95
Orion Software	6
PEEK(65)	73
Perry Peripherals	39
Pretzelland	37
Pterodactyl Software	102
Quantin Research	52
R C Electronics	71
Sensible Software	89
SGC	25
6502 Program Exchange	85
Skyles Electric Works	74
Softel	100
Softronics	4
Software Farm	91
Spectrum Systems	98
Star Micronics	26
Tau Lambda	15
Universal Data Research	104
Versa Computing, Inc.	22
Victory Software	11
Voicetek, Inc.	63
John Wiley & Sons	2
XPS, Inc.	104

MICRO INK is not responsible for claims made by its advertisers. Any complaint should be submitted directly to the advertiser. Please also send written notification to MICRO.

Next Month in MICRO

Commodore Feature

- **SuperPET's Waterloo ASCII Character Set** — A description of the ASCII character set used in the Waterloo interpreters supplied with the SuperPET.
- **BASIC Squeeze** — A routine to squeeze out imbedded blanks, line separators, and comments for a BASIC program.
- **Microcomputers in the Chemical Engineering Curriculum, Part 2** — Analog transducers in a digital world.
- **Add a BASIC Line Delete Command** — A BASIC line delete command allows the user to delete blocks of BASIC program lines at the touch of a single key. The article shows how to implement this command, in machine language, on Commodore computers, including the VIC-20.
- **SOUP** — An efficient compare program for machine-language program files on Commodore disk. Uses BASIC 4.0 disk commands, but is otherwise compatible with other Microsoft BASICs.

- **It's All Relative — CBM Disk Techniques, Part 1** — An explanation of how to get the most from CBM's powerful disk operating system. Examples are drawn from a well-written mailing list package.
- **VIC Jitter Fixer** — Add this routine to your programs to help get reliable readings from your VIC paddle, joystick, and light pen registers.

And more...

BASIC Macro Function for Cursor Control on the OSI

Applesoft GOTO/GOSUB Checking Routine

Logic Instructions of the 68000

Atari Graphics

New Columns!

CoCo Bits — for the Color Computer

From Here to Atari returns

20% OFF

Your money goes farther when you subscribe. During the course of a year, when you subscribe, you save 20% (in the U.S.).

Pay only \$24.00 (\$2.00 a copy) for 12 monthly issues of MICRO sent directly to your home or office in the U.S.

More MICRO for Less Money When You Subscribe

But on the newsstand — if you can locate the issue you want — you pay \$30.00 a year (\$2.50 a copy).

Special Offer — Subscribe for 2 years (\$42.00) and get 30% off the single issue price.

Subscribe to MICRO today.

MICRO
34 Chelmsford Street
P.O. Box 6502
Chelmsford, MA 01824

Please send me MICRO for 1 year 2 years
NOTE: Airmail subscriptions accepted for 1 year only.

Check enclosed \$ _____
Charge my _____ VISA account
_____ Mastercard account

No. _____

Expiration date _____

Name _____

Address _____

City/State _____ Zip _____

Subscription Rates Effective January 1, 1982

Country	Rate
United States	\$24.00 1 yr. 42.00 2 yr.
Foreign surface mail	27.00
Europe (air)	42.00
Mexico, Central America, Mid East, N. & C. Africa	48.00
South Am., S. Afr., Far East, Australasia, New Zealand	72.00

* Airmail subscriptions accepted for only 1 year.
For U.S. and Canadian 2-year rates, multiply by 2.

Job Title: _____

Type of Business/Industry: _____



Turn your Apple into the world's most versatile personal computer.

The SoftCard™ Solution. SoftCard turns your Apple into two computers. A Z-80 and a 6502. By adding a Z-80 microprocessor and CP/M to your Apple, SoftCard turns your Apple into a CP/M based machine. That means you can access the single largest body of microcomputer software in existence. Two computers in one. And, the advantages of both.

Plug and go. The SoftCard system starts with a Z-80 based circuit card. Just plug it into any slot (except 0) of your Apple. No modifications required. SoftCard supports most of your Apple peripherals, and, in 6502-mode, your Apple is still your Apple.

CP/M for your Apple. You get CP/M on disk with the SoftCard package. It's a powerful and simple-to-use operating system. It supports more software than any other microcomputer operating system. And that's the key to the versatility of the SoftCard/Apple.

BASIC included. A powerful tool, BASIC-80 is included in the SoftCard package. Running under CP/M, ANSI Standard BASIC-80 is the most powerful microcomputer BASIC available. It includes extensive disk I/O statements, error trapping, integer variables, 16-digit precision, extensive EDIT commands and string functions, high and low-res Apple graphics, PRINT USING, CHAIN and COMMON, plus many additional commands. And, it's a BASIC you can compile with Microsoft's BASIC Compiler.

More languages. With SoftCard and CP/M, you can add Microsoft's ANSI Standard COBOL, and FORTRAN, or

Basic Compiler and Assembly Language Development System. All, more powerful tools for your Apple.

Seeing is believing. See the SoftCard in operation at your Microsoft or Apple dealer. We think you'll agree that the SoftCard turns your Apple into the world's most versatile personal computer.

Complete information? It's at your dealer's now. Or, we'll send it to you and include a dealer list. Write us. Call us.

SoftCard is a trademark of Microsoft. Apple II and Apple II Plus are registered trademarks of Apple Computer. Z-80 is a registered trademark of Zilog, Inc. CP/M is a registered trademark of Digital Research, Inc.

MICROSOFT

CONSUMER PRODUCTS

MICROSOFT Inc.
10700 Northup Way • Bellevue, WA 98004

THE PROWRITER COMETH.

(And It Cometh On Like Gangbusters.)



Evolution.

It's inevitable. An eternal verity.

Just when you think you've got it knocked, and you're resting on your laurels, somebody comes along and makes a dinosaur out of you.

Witness what happened to the Centronics printer when the Epson MX-80 came along in 1981.

And now, witness what's happening to the MX-80 as the ProWriter cometh to be the foremost printer of the decade.

SPEED

MX-80: 80 cps, for 46 full lines per minute throughput.

PROWRITER: 120 cps, for 63 full lines per minute throughput.

GRAPHICS

MX-80: Block graphics standard, fine for things like bar graphs.

PROWRITER: High-resolution graphics features, fine for bar graphs, smooth curves, thin lines, intricate details, etc.

PRINTING

MX-80: Dot matrix business quality.

PROWRITER: Dot matrix correspondence quality, with incremental printing capability standard.

FEED

MX-80: Tractor feed standard; optional friction-feed kit for about \$75 extra.

PROWRITER: Both tractor and friction feed standard.

INTERFACE

MX-80: Parallel interface standard; optional serial interface for about \$75 extra.

PROWRITER: Parallel and serial interface standard.

WARRANTY

MX-80: 90 days, from Epson.

PROWRITER: One full year, from Leading Edge.

PRICE

Heh. heh.

Distributed Exclusively by Leading Edge Products, Inc., 225 Turnpike Street, Canton, Massachusetts 02021. Call: toll-free 1-800-343-6833; or in Massachusetts call collect (617) 828-8150. Telex 951-624.

LEADING EDGE.

For a free poster of "Ace" (Prowriter's pilot) doing his thing, please write us.